

BARIL

— STYLE X FUNCTION

EDITION

37

BARIL

STYLE x FUNCTION

At BARIL, we're less about faucets. Ok, we're a lot about faucets. But we're more about you, your life and the role we play in it. Understanding the bigger picture; from your grand vision to your day-to-day rituals. Feeding your imagination with style inspiration and improving your life through product innovation. Creating the spaces that you're proud to live in and crafting the little details you can't live without. Faucets designed to please your eyes in an instant and engineered to withstand your touch for a lifetime. Experience innovation driven by consumer benefit and service delivered with unparalleled consideration for your needs.

The Baril Family: *Robinetier by love of the craft**

Driven by its passion for the avant-garde, the family-owned business excels in the design, manufacture and distribution of unique faucets.

*Robinetier: (From french) Master craftsman in the art faucets making.

Designed by BARIL in Montréal

Before being assembled in Canada, all BARIL faucets begin in the minds of our designers who, as their city, bring a European sensibility to the North American market.

Quality and Reliability since 1986

Relying on expertise finely developed over 35 years, our team focuses on research and constant improvement to craft durable, flawless faucets.

Lifetime Warranty on Products and Service

We proudly warranty all our products for life against manufacturing defects and we also provide professional, fast and personalized after-sales service. Just call us!



BARILDESIGN.COM

1 800 463.3871

Welcome

BARIL

Summary

USD Price List

Introduction

3-40

Legend	10
Selection of Finishes	12
BARIL Features	17
Our Story	36

Electronic (New!)

41-44

Touchless Sensor	42
------------------	----

Kitchen

45-64

Kitchen Faucets	45
Kitchen Parts	59

Bathroom

65-312

Bathroom Faucets	65
Bathroom Accessories	293
Bathroom Parts	307

Shower

313-382

Shower Valves
Shower Components

313
347

Information & Forms

383-392

General Information
Care Instructions
Warranty
Customer Service Policies
Service Call Form
FAQ

383
384
385
388
389
391

Price Index

393-444

BARILDESIGN.COM

1 800 463.3871
1 877 693.3005 [fax]
info@barildesign.com

MONTREAL | DESIGN STUDIO

5394, blvd. St-Laurent
Montreal (Quebec)
Canada H2T 1S1

TROIS-RIVIERES | HEAD OFFICE

579, blvd. Ste-Madeleine
Trois-Rivieres (Quebec)
Canada G8T 9J8

Overview

Kitchen Faucets

Industrial Style



TECH IV
51



TECH VI
57

VISION Original



VISION H15
51



VISION H13
53

VISION Reimagined



VISION III (12L)
53



VISION III (22L)
53



VISION III (32L)
53



VISION IV (12L)
54



VISION IV (22L)
54



VISION IV (32L)
54

Overview

Kitchen Faucets

ARTE Family



ARTE H19
55



ARTE H16
55



ARTE H13
55



ARTE
57



ARTE
58

UNICK Family



UNICK III
50



UNICK II
51



UNICK II
50



UNICK
57



UNICK
58



UNICK
58

TUBE Family



TUBE H15
56



TUBE H13
56



TUBE II
56

ANGLE



ANGLE
50



Overview

Bathroom Collections

Modern Collections



B04 PETITE
65



B05 REC
87



B14 OVAL
103



B26 HAÜS-D
117



B27 HAÜS-C
117



B28 HAÜS-L
117



B45 SENS
135



B46 PROFILE
151



B47 FLORA
167



B66 ZIP
195



Overview

Bathroom Collections

Design Collections



B35 MARIE
127



B51 MA
179



B56 ACCENT
185



B80 AIR
231



Classic Collections



B16 NAUTICA
109



B18 RALPH
109



B71 EVA
215



B72 TRADITION
215



B74 VICTOIRE
223

Legend Faucets

__ : Double Underscores
Collection's number

XX: Capital Letters

The X included in the product code indicates that additional options are offered with the product. For example, a choice of regular or pressure balanced version for a tub faucet.

xx: Finish

The xx included at the end of the product code indicates that you must choose the desired finish.

Measurements:

L: Length / H: Height / P: Depth

The Essentials

Products and finishes that are part of The Essentials booklet are identified in square brackets. These are our bestsellers, available at competitive prices and fast shipping.

B__-8009-XXL-xx



THE ESSENTIALS

CC	KK	LL	BB	NN/YY	VV/TT	KM	GG

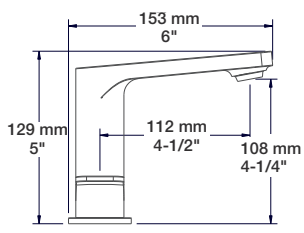

8" c/c lavatory faucet, drain included

- A- Max: 1.5 gpm - 60 psi
- B- Push-button drain with overflow included
- C- Easy to clean adjustable silicone aerator
- D- CAR-3820-01 (Cold), CAR-3820-02 (Hot)

Ecological options

Codes	Reduced flow rates	CEC
B04-8009-00L-xx-120	1.2 gpm (4.5 l/min) - 60 psi	
B04-8009-00L-xx-100	1.0 gpm (3.7 l/min) - 60 psi	
B04-8009-00L-xx-050	0.5 gpm (1.9 l/min) - 60 psi	

Touchless Sensor

This icon indicates that the faucet is compatible with the Touchless Sensor.



Order sensor ELE-1001-01-xx



Order sensor ELE-2001-01-xx

Product Features

Ecological Options

This table shows the ecological options available and the equivalent reduced flow rates. Options marked with a CEC icon meet California Energy Commission requirements.

Legend Shower Kits

One code for your complete shower kit

In order to facilitate the options, BARIL offers already assembled shower kits which include all the components necessary for the proper performance of your water accessories. Thereby, you only have to order one product code with a single price for the whole shower kit. The shower kits that include a rain head are offered with a wall-mounted arm (PRO) or with a ceiling-mounted arm (PRR). Alternatively, you can also purchase the rough(s) and the trim kit (TRO or TRR for ceiling-mounted shower heads) separately, according to the step of your project. The pressure balanced and thermostatic pressure balanced roughs are offered in two versions: with PEX connections or with 1/2" male NPT or welded copper connections. When relevant, the option to choose a shower kit without a shared position is offered.

Your customer wants to be unique?







Customize your shower kit with the BARIL collection; there are thousands of custom shower kit possibilities with a complete selection of shower components. In each collection, we suggest a selection of shower components that harmoniously fit with the shower valves of the collection and a selection of ecological shower components on the following page.

You can either put together your own shower kit with the products of the shower section, or by modifying one or more products of an already assembled PRO/PRR shower kit! All you need to do is calculate the price difference.

Complete product code

Price

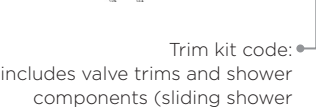
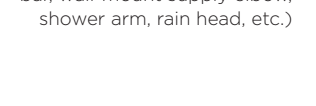
Products and finishes that are part of The Essentials booklet are identified in square brackets. These are our bestsellers, available at competitive prices and fast shipping.

PRO-4205-04-xx PRR-4205-04-xx*		Complete thermostatic pressure balanced shower kit	CC	KK	LL	BB	NN/YY	VV/TT	KM	GG
		Features A- 2 accessories kit B- Max: 2 gpm - 80 psi (per accessory) C- 3-spray hand shower D- 2 accessories can work together	0000							
		Includes B04-9521-00-xx Complete type TP shower valve with 2-way diverter TET-0815-01-xx 8" rounded square shower head BRA-1612-66-xx 16" shower arm DGL-2584-53-xx 3-spray sliding shower bar RAC-9001-16-xx Wall-mount supply elbow								
		Ecological options <small>CEG</small>	Codes PRO-4205-04-xx-NS TRO-4205-04-xx-NS + RVA-9521-00-NS-B		Features are the same, except: B- Max: 1.75 gpm - 80 psi (per accessory) D- 1 accessory works at a time					
		TRIM ONLY TRO-4205-04-xx TRR-4205-04-xx*								
		ROUGH VALVES Please order one of the following rough valves to complete the trim:								
		RVA-9521-00-B 2-way type TP rough - 1/2" male NPT or welded copper connections								
		RVA-9521-PO-B 2-way type TP rough - PEX connections								

Trim kit code: includes valve trims and shower components (sliding shower bar, wall-mount supply elbow, shower arm, rain head, etc.)

Rough(s) to order to complete the trim (TRO/TRR).

Product codes to order for a non-shared version of the shower kit.

Components

BARIL's Finishes

Because we are convinced that you want access to the very best options, BARIL offers a large variety of finishes for all of its collections. Chrome (CC) and stainless steel (SS) finishes are in stock with a 48-hour shipping time. A selection of products in matte black, white and satin brass finishes is also kept in inventory for shipment within 48 hours. All of our other finishes are generally available with fast shipping of 4 weeks or less.

Take advantage of this wide range of colors and have fun with all these possibilities.

* Some finishes are exclusive to certain collections.

Fast Delivery Finishes



CC
Chrome
(shipping within 48h)



SS
Stainless Steel
(shipping within 48h)



KK
Matte Black
(shipping within 48h or 4 weeks)



BB
White
(shipping within 48h or 4 weeks)



LL
Satin Brass
(shipping within 48h or 4 weeks)

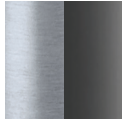

SF
Smokey
Stainless
Steel



CB
Chrome
White



CF
Smokey
Chrome



CD
Chrome
Diamond



KM
Black
Titanium



E
Glossy Black



H
Blush

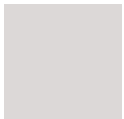

I/II
Mist



J/JJ
French
Gold

Special Finishes

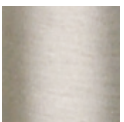

NN
Brushed Nickel
(shipping within 2 weeks)



YY
Polished Nickel
(shipping within 2 weeks)



VV
Satin Copper
(shipping within 4 weeks)

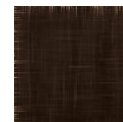

TT
Venetian Bronze
(shipping within 4 weeks)

Premium Finish

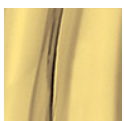

GG
Gold
(shipping within 4 weeks)

BARIL's Finishes

Solid Finishes



→ Chrome (CC)



→ Matte Black (KK)



→ White (BB)



→ Satin Brass (LL)



→ Black Titanium (KM)



→ Brushed Nickel (NN)



→ Polished Nickel (YY)



→ Satin Copper (VV)



→ Venetian Bronze (TT)



→ Gold (GG)

BARIL's Finishes

Two-tone Finishes



Featured product: CUI-9249-12L-KL

Featured product: CUI-9249-22L-CK



Featured product: CUI-9250-12L-LK

Featured product: CUI-9250-22L-SK



Featured product: B56-1010-00L-xx

Marketing Tools

The Displays

With its contemporary shades and its integrated lighting, the BARIL presentation wall has an attractive impact on the customer and brings a sophisticated touch to your showroom. Each faucet is installed on a plate and is simply placed on a shelf; it can thereby be moved as you wish. Podiums are also available to highlight BARIL kitchen faucets and floor-mounted tub faucets.



The Brochures

To help you get to know our collections, and to inspire you, our brochures are available on our website at all times and in hard copy on demand.



Marketing Tools

The Essentials Booklet

More than just a brochure, The Essentials booklet is the perfect sales tool! It features our bestsellers, timeless styles available in our 4 most popular finishes. In addition, you benefit from very competitive prices and 48-hour shipping on all these products.



You can also find them in the catalog by looking for products identified as “The Essentials”.

B04-8009-00L-xx



THE ESSENTIALS

CC	KK	LL	BB	NN/YY	VV/TT	KM	GG



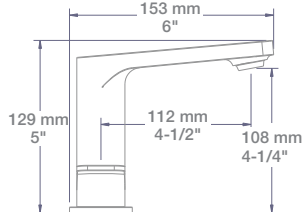

8" c/c lavatory faucet, drain included

A- Max: 1.5 gpm - 60 psi
 B- Push-button drain with overflow included
 C- Easy to clean adjustable silicone aerator
 D- CAR-3820-01 (Cold), CAR-3820-02 (Hot)

Ecological options

Codes	Reduced flow rates
B04-8009-00L-xx-120	1.2 gpm (4.5 l/min) - 60 psi
B04-8009-00L-xx-100	1.0 gpm (3.7 l/min) - 60 psi
B04-8009-00L-xx-050	0.5 gpm (1.9 l/min) - 60 psi

Our Features

BARIL

BARIL in Short

STYLE x FUNCTION

At BARIL, we're less about faucets. Ok, we're a lot about faucets. But we're more about you, your life and the role we play in it. Understanding the bigger picture; from your grand vision to your day-to-day rituals. Feeding your imagination with style inspiration and improving your life through product innovation. Creating the spaces that you're proud to live in and crafting the little details you can't live without. Faucets are designed to please your eyes in an instant and engineered to withstand your touch for a lifetime.

The BARIL Family: ***Robinetier** by love of the craft**

Driven by its passion for the avant-garde, the family-owned business excels in the design, manufacture and distribution of unique faucets.

*Robinetier: (from french) master craftsman in the art of faucets making.

Designed by BARIL **in Montreal**

Before being assembled in Canada, all BARIL faucets begin in the minds of our designers who, as their city, bring a European sensibility to the North American market.

Quality and Reliability since 1986

Relying on expertise finely developed over more than 35 years, our team focuses on research and constant improvement to craft durable, flawless faucets. BARIL faucets are robust, built with high-quality materials and advanced technical components. All products are carefully controlled and tested by our quality department at each step of manufacturing.

Lifetime Warranty on Products and Service

We proudly warranty all our products for life against manufacturing defects, and we also provide professional, fast and personalized after-sales service. Just call us at 1.800.461.3871 or write to us at info@barildesign.com, and it will be our pleasure to answer any question on products or installation. Our sales representatives and customer service professionals are trained by our product experts. They know how to support you in case of any problem you might encounter, and replacement parts are available during the whole product's life.

Shipping Within 48 Hours

There is a sales office and a warehouse in Trois-Rivieres that will ship you any order in less than 48 hours. When you order at BARIL, we can answer your demands right away because your order is directly linked to our stock managing system, less than 20 meters away. In less than 48 hours, the majority of your orders will be ready to be delivered to your doorstep.

Certifications

All BARIL products are compliant with the following standards:

ASME A112.18.1/CSA B125.1
Standard governing guarantee relating to the product's mechanisms and durability of its finish

NSF 372
Standard governing water quality for lavatory and sink faucets

NSF/ANSI 61
Standard governing materials that come into contact with drinking water

ASSE 1016
Standard governing water temperature control in shower systems

BARIL FAUCETS ARE COMPLIANT WITH ALL FEDERAL AND STATE DRINKING WATER LEGISLATION.

FOR SPECIFIC MASSACHUSETTS LEGISLATION, A LIST OF COMPLIANT SKUs IS AVAILABLE UPON REQUEST.

BARIL products are certified by at least one of the following organizations:



ADA CERTIFICATION

All products displaying the ADA logo will comply with the applicable ADA requirements as specified in the Americans with Disabilities Act as follows: faucets with lever, wrist blade, blade, cross/six-prong or T-handles products displaying the ADA symbol will comply with the actuation force Accessibility Guidelines, Section 309 Operation, of the Act.



WATERSENSE CERTIFICATION

All items with the WaterSense logo meet or exceed the certification criteria as of the EPA's WaterSense Program. WaterSense labelled bathroom sink faucets that use a maximum of 1.5 gallons per minute (5.7 l/min) can reduce a faucet's water flow by 30 percent or more from the standard flow of 2.2 gallons per minute (8.3 l/min) without sacrificing performance. Same for hand shower and shower head, for which the flow rate as been reduced to 1.75 gpm (6.6 l/min) instead of the industry standard of 2.5 gpm (9.5 l/min). WATERSENSE® is a registered mark of the U.S. Environmental Protection Agency.



CEC CERTIFICATIONS

All items with the CEC logo feature an option that meets the California Energy Commission requirements. To be CEC-listed, lavatory faucet must use a maximum of 1.2 gallons per minute (4.5 l/min), kitchen faucet and shower head must not exceed 1.8 gallons per minute (6.8 l/min) and shower valve must be without shared position. These measures ensure significant water saving and can be applied to many BARIL products.



CALGREEN CERTIFICATION

All items with the CALGreen logo meet the California Green Building Standards Code (known as CALGreen). Lavatory faucets with a 20% reduction or over meet the CALGreen certification criteria. Many BARIL faucets and shower components comply with the California Green Building Standard Code (known as CALGreen). A faucet with a 20% reduction or over of the water flow meets the CALGreen certification criteria.



Intertek



IAPMO



Canadian Standards Association

Water Flows

Faucet Flow Rate

BARIL offers faucets adapted to most North American standards.
BARIL's regular product water flow are:

Kitchen Faucets

1.8 gpm to 2.2 gpm (6.8 to 8.3 l/min)
depending on the model - 60 psi

Lavatory Faucets

1.5 gpm (5.7 l/min) - 60 psi

Tub Faucets

5.3 gpm to 9.2 gpm (20 to 35 l/min)
depending on the model - 60 psi

Shower Components (hand shower, shower head, etc.)

2 gpm to 2.5 gpm (7.6 to 9.5 l/min)
depending on the model - 80 psi

Shower Valves

5 gpm to 16 gpm (19 l/min to 60 l/min)
depending on the model - 60 psi

The thermostatic valves and T/P valves offer the best flow on the market with performances up to 16 gpm (60 l/min) - 60 psi.

* See specific products in the catalog to confirm their exact flow.

Ecological Options

BARIL faucets offer different options to help you obtain LEED certification or comply with your local regulations. Add the ecological option of your choice for free.

Kitchen Faucets

Regular
Option 1
Option 2

Flow

2.2 gpm (8.3 l/min) - 60 psi
1.75 gpm (6.6 l/min) - 60 psi
1.5 gpm (5.7 l/min) - 60 psi

How to Order

use regular code
add -175 at the end of the code
add -150 at the end of the code

Lavatory Faucets

Regular
Option 1
Option 2
Option 3

Flow

1.5 gpm (5.7 l/min) - 60 psi
1.2 gpm (4.5 l/min) - 60 psi
1.0 gpm (3.7 l/min) - 60 psi
0.5 gpm (1.9 l/min) - 60 psi

How to Order

use regular code
add -120 at the end of the code
add -100 at the end of the code
add -050 at the end of the code

Shower Components

Regular
Option 1
Option 2

Flow

2.0 gpm (7.6 l/min) - 80 psi
1.75 gpm (6.6 l/min) - 80 psi
1.5 gpm (5.7 l/min) - 80 psi

How to Order

use regular code
add -175 at the end of the code
add -150 at the end of the code

High-End Components

Quality Faucets

BARIL faucets are all **forged of solid brass** and comply with the highest quality certifications and manufacturing standards, including low lead content and material thickness above standards. These advantages **lower the risks of manufacturing defects**.



Cartridges

BARIL uses **high-quality ceramic disk cartridges** made in Europe. The ceramic disk cartridges use a pair of ceramic disks that lie against each other to control water flow. Being an extremely strong material, ceramic **resists cracking and withstands extreme temperatures**. Because the disks are polished to a near-perfect flatness, the seal between them is watertight. This technology eliminates wear on rubber seals and extends the cartridge's service life.



High-End Components

Leak-proof and Anti-twist Water Inlet Hoses

At BARIL, we care about conceiving smart products. Therefore, we think about facilitating our products' installation, and we ensure to minimize leaking risks. At BARIL, your kitchen and single hole lavatory faucet water inlet hoses are **made of polyamide/PEX**, a material that doesn't rust and doesn't react to chemicals*. The kitchen and single hole faucet hoses, in addition to being **corrosion-resistant**, are directly connected to the faucet's brass body, **reducing leaking risks** compared to faucets with a copper pipe extension. This assembly also ensures **an easier installation** and facilitates tightening with fewer connections.

These BARIL's inlet hoses, developed in collaboration with Neoperl, a leading manufacturer in this field, are **robust, flexible, lightweight and glide smoothly** thanks to their special braiding. The inner hose is made of Softpex (cross-linked polyethylene), a material proved millions of times in the market with a **0% failure rate**. BARIL's inlet hoses are **torsion-resistant** thanks to their quality material and are also designed with swivel connection nuts at the water inlets, avoiding torsion when tightening them.

* Please note that it's important to warn users to store corrosive products in a secure space, and away from corrodible parts, such as older faucets or products from other manufacturers. It is strongly recommended to verify your faucets' connections every six (6) months.

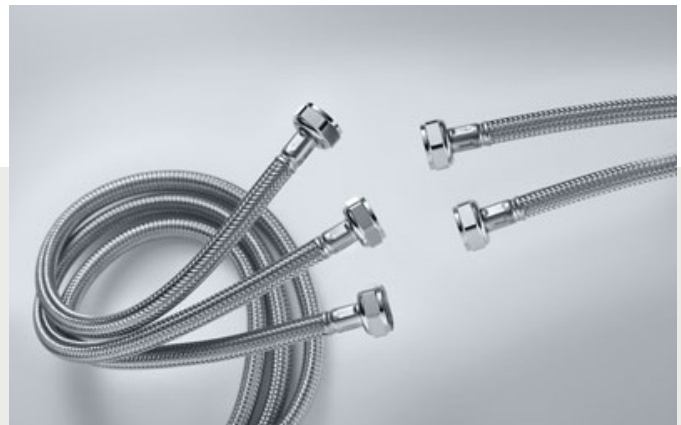

High-End Components

Aerators



The perfect stream with BARIL

While some faucet aerators serve only to control the flow rate, BARIL's faucet aerators do much more: they also **control the stream straightness** and diameter, **reduce splash** by aerating the stream and eliminating side spray, **save water and reduce energy costs**, and meet North American plumbing codes and standards. Faucet aerators introduce air into the water stream to produce a **larger white stream, soft to the touch** and splash-free. BARIL's faucet aerators are helping to reduce lime build-up. BARIL uses Swiss-made Neoperl aerators, considered some of the world's best.

BARIL offers complementary options on some faucet models, such as adjustable aerators, low-flow aerators for your most demanding energy-saving projects, design stream aerators such as waterfall streams, and much more.



Adjustable Aerator

Sometimes, when a faucet is installed with a wash basin, the faucet stream's direction isn't optimal (water splashing, difficulty rinsing hand, etc.). BARIL solves this problem by offering this aerator to **allow adjustments in the water stream's direction** to ease the choice of wash basin and to improve user comfort. The angle of the water stream can be adjusted directly at the aerator, simply by moving the adjustable tilting plate with your finger (**± 6° up to ± 10°, depending on the aerator model**). In the basic position, the adjustable version is visually identical to the standard version.

This benefit is integrated in some lavatory faucets of the following bathroom collections:

B51 MA / B56 ACCENT / B04 PETITE / B05 REC / B14 OVAL / B16 NAUTICA / B18 RALPH / B35 MARIE / B45 SENS / B46 PROFILE / B47 FLORA / B66 ZIP / B71 EVA / B72 TRADITION / B74 VICTOIRE / B80 AIR

See all available products in the corresponding collections!

Kitchen Faucets Advantages



180° Swivel Spout

Allows to reach all areas of the sink.

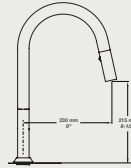

Good Faucets' Ergonomics

Convenient to fill large pots and tall pitchers.

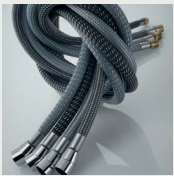

Easy-to-handle Hand Spray Hose

Glide without noise, lightweight and flexible.



Super Swivel Hand Spray

The integrated ball joint of the hand spray hose makes it very easy to rotate.

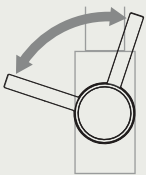

Comfort of Use Even in Tight Spaces

The handle rotates towards the back of only 15° to avoid knocking against the backsplash area.



Cool Start

Kitchen faucets open on cold water when the handle is in the upward position, allowing energy savings and avoiding risks of burns.

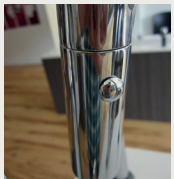

Automatic Docking

The automatic docking ensures the spray will return to its place after each use, and that it will firmly stay in place.

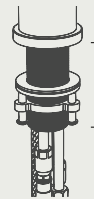

Thick Counter

Installation tube of 2-1/2'' to allow fitting on very thick counters (max. 2'').

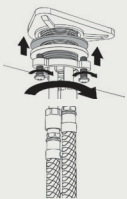

Easy Installation

Very steady and simple installation of faucets thanks to our threaded nut with 3 screws easily reachable, even in a tight location.



Solid Installation

Included spacer and assembly triangle with all kitchen faucets to be used under the sink in order to solidify during installation on a very thin sink.



Hand Spray Return Strength

The strength of return of the hand spray is adjustable according to the user's wish when using the included weight and/or spring.

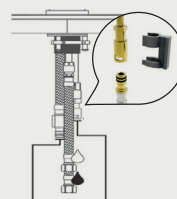

Quick Connection

The brass connection facilitates the hand spray hose's connection to the water supply. Complete the connection with a simple click, no tools are required.

Some features apply to a limited number of models.

Shower Products Advantages

External Thermostatic Shower Column

1. Temperature's handle is on the hot water inlet side, allowing the surface's temperature never to exceed the shower's water temperature.

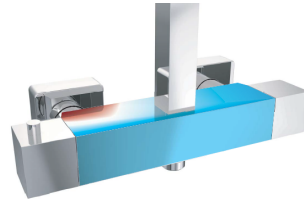

Water distribution with temperature handle on the HOT water inlet side.

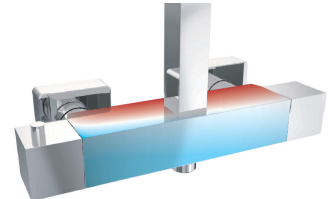

Water distribution with temperature handle on the COLD water inlet side.

2. Accessory indicator on top of the diverter handle. This diverter handle can turn 360° in either direction.

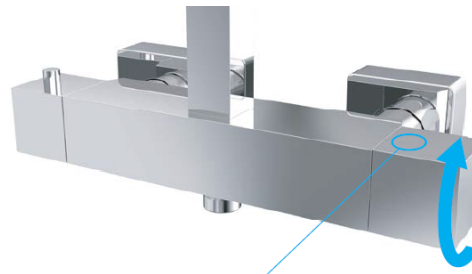

3. With the external thermostatic valves on BARIL shower columns, your two water accessories can work individually or simultaneously.



No water flow



Water flow through the hand shower only

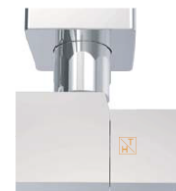

Water flow through both hand shower and shower head simultaneously



Water flow through the shower head only

4. The shower head arm can be adjusted up to 20" in height to allow maximum comfort in your shower.

5. Security: the temperature on our valve is set at 38 °C / 100° F and can be raised by pressing the button and turning the handle counterclockwise.

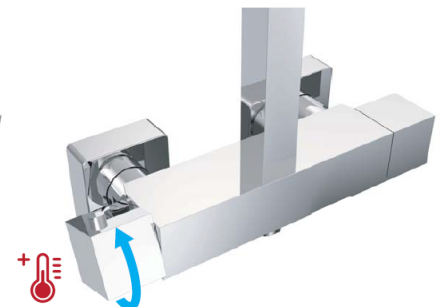
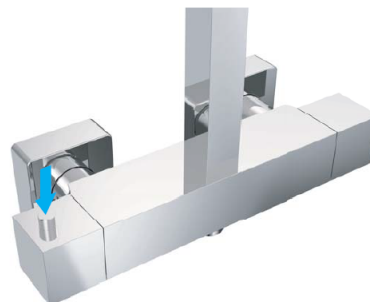

Shower Products Advantages

Shower Valves

BARIL specialized in shower faucets since our beginnings more than 35 years ago. BARIL has always integrated the best shower valve technologies, such as European technologies with thermostatic valves and North American technologies with pressure balanced valves. BARIL uses the highest water flow valves on the market in their respective categories.

Here is a summary of the large selection of valves offered by BARIL, each of them responding to different and/or complementary needs:

Pressure Balanced (Type P valve)

- Pressure balanced valve
- Pressure balanced valve with 2-way diverter (available with shared or non-shared position)
- Pressure balanced valve with 3-way diverter (available with shared or non-shared position)

Thermostatic (Type T valve)

- External thermostatic valve
- 3/4" thermostatic valve
- With several options of volume control valves or diverters with off (available with shared or non-shared position)

Thermostatic Pressure Balanced (Type TP valve)

- 2-way thermostatic pressure balanced valve (available with shared or non-shared position)
- 3-way thermostatic pressure balanced valve (available with shared or non-shared position)

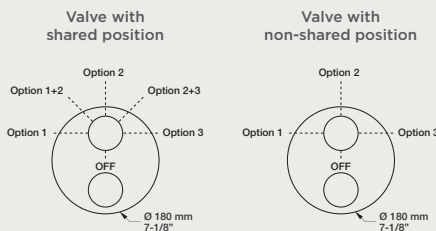

Compact valves with shared position and non-shared position

Some of our pressure balanced, thermostatic or thermostatic pressure balanced shower kits are equipped with a built-in diverter valve that allows the use of 2 or 3 accessories individually, and 2 accessories simultaneously. Alternatively, you can choose those same shower kits with a non-shared position, allowing only one accessory to work at a time.

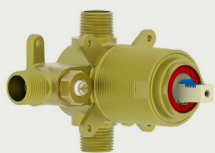

High quality trim and ease of installation

We thought about your decor and your clients: BARIL shower valves plates are without visible screws. Furthermore, we offer easy installation with flat back rough-ins and depth-adjustable trims.

Shower Products Advantages

Shower Valve Cartridge Types



Pressure Balanced Valve

Shower valve allows to balance the pressure fluctuations caused by the water use in the house. A piston or diaphragm system reacts to cold or hot water pressure variations and will compensate by allowing more or less water to go through on the opposite side. This valve ensures a stable water temperature and no risk of burns.

Pressure Balanced Cartridge Operation

The pressure balanced cartridge works only on the water pressure and not on the temperature itself. It balances the cold water pressure with the hot water pressure. By keeping the same pressure on both sides, the water temperature stays almost the same.



Thermostatic Valve

The thermostatic valve is mostly used in the shower and its purpose is to ensure temperature stability. The thermostatic technology allows great water flow and the possibility of using two water outlets at the same time. The thermostatic valve cartridges react to the slightest water temperature variation, which allows a precise temperature. This valve is safe with its 38 °C / 100 °F stop button (available in most collections). On a thermostatic valve, temperature selection isn't required at each use. The thermostatic valve must be installed with a diverter or a volume control valve for each accessory it supplies.



Thermostatic Cartridge Operation

A thermostatic component (paraffin) contracts or dilates depending on the mixed water temperature, thereby activating cold and hot water inlets' opening or closure in order to adjust the exit water temperature. This mechanism allows to maintain the set temperature at the exit.

Thermostatic Pressure Balanced Valve

This valve combines the benefits of pressure balanced and thermostatic valves in terms of temperature regulation, with an intermediate flow between both valve types. The cartridge regulates the temperature to a precise temperature, which can be pre-selected, by reacting to the slightest temperature variations. Therefore, the exit water temperature remains unchanged, regardless of the temperature and pressure variations of the hot and cold water inlets. Finally, this valve is safe with its 38 °C / 100 °F stop button (available in most collections). The T/P valve meets the most strict performance criteria in terms of temperature and pressure variations, as defined by the ASSE 1016 - 2011 standard.

Thermostatic Pressure Balanced Cartridge Operation

This cartridge is a high-performance thermostatic cartridge (high flow, very low temperature fluctuations), whose thermostatic mechanism is developed and manufactured in Europe by the world leader in cartridge manufacturers.



Rough-in Valves Advantages

Pressure Balanced Valve

RVA-9020-00-B RVA-9020-P0-B

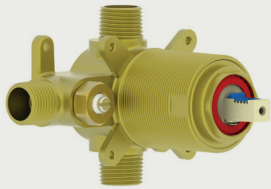

1/2" male NPT or
welded copper connections

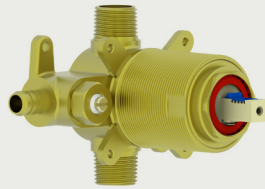

PEX inlets and 1/2" male NPT or
welded copper outlets connections

A- Type P faucet
B- Built-in check-stop valves accessible from the front
of the rough-in
C- Water flow of 6.1 gpm - 60 psi

- Volume control with temperature memory
- Temperature variation of less than 2 °C / 3.6 °F, making it one of the types of valves with the least temperature variation on the market
- Manually adjustable temperature limiting device
- Ceramic disk cartridge made from high-strength, high-density materials allowing a longer life span
- Cartridge included with the rough-in
- Front access, easy-to-change cartridge
- Thicker brass compared to competitors
- Included template for easy installation
- Flat back for easy installation
- Trim depth adjustment range of 1/2"
- Wall mounting anchor points molded in the rough-in valve
- Lifetime warranty against manufacturing defects

Rough-in Valves Advantages

Pressure Balanced Valve with 2-way Diverter

RVA-9181-00-B
RVA-9181-00-NS-B

RVA-9181-PO-B
RVA-9181-PO-NS-B

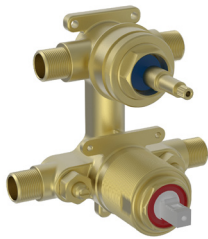

1/2" male NPT or
welded copper connections



PEX connections

- A- Type P faucet
- B- RVA-9181-xx-B: 2-way diverter, shared ports
- C- RVA-9181-xx-NS-B: 2-way diverter, non-shared ports
- D- Built-in check-stop valves accessible from the front of the rough-in
- E- Water flow of 5 gpm - 60 psi

- Volume control with temperature memory
- Temperature variation of less than 2 °C / 3.6 °F, making it one of the types of valves with the least temperature variation on the market
- Manually adjustable temperature limiting device
- Ceramic disk cartridge made from high-strength, high-density materials allowing a longer life span
- Cartridges included with the rough-in
- Front access, easy-to-change cartridges
- Thicker brass compared to competitors
- Included template for easy installation
- Flat back for easy installation
- Trim depth adjustment range of 1/2"
- Wall mounting anchor points molded in the rough-in valve
- Lifetime warranty against manufacturing defects

Pressure Balanced Valve with 3-way Diverter

RVA-9191-00-B
RVA-9191-00-NS-B

RVA-9191-PO-B
RVA-9191-PO-NS-B

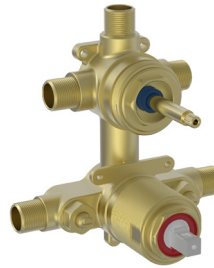

1/2" male NPT or
welded copper connections

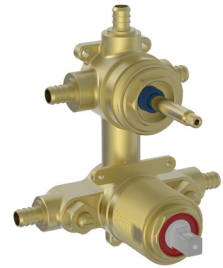

PEX connections

- A- Type P faucet
- B- RVA-9191-xx-B: 3-way diverter, shared ports
- C- RVA-9191-xx-NS-B: 3-way diverter, non-shared ports
- D- Built-in check-stop valves accessible from the front of the rough-in
- E- Water flow of 5 gpm - 60 psi

- Volume control with temperature memory
- Temperature variation of less than 2 °C / 3.6 °F, making it one of the types of valves with the least temperature variation on the market
- Manually adjustable temperature limiting device
- Ceramic disk cartridge made from high-strength, high-density materials allowing a longer life span
- Cartridges included with the rough-in
- Front access, easy-to-change cartridges
- Thicker brass compared to competitors
- Included template for easy installation
- Flat back for easy installation
- Trim depth adjustment range of 1/2"
- Wall mounting anchor points molded in the rough-in valve
- Lifetime warranty against manufacturing defects

Rough-in Valves Advantages

Thermostatic Valve with 2-way Diverter

RVA-9521-00-B
RVA-9521-00-NS-B

RVA-9521-PO-B
RVA-9521-PO-NS-B

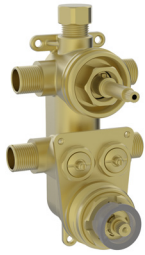

1/2" male NPT or
welded copper connections

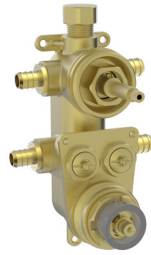

PEX connections

Thermostatic Valve with 3-way Diverter

RVA-9531-00-B
RVA-9531-00-NS-B

RVA-9531-PO-B
RVA-9531-PO-NS-B



1/2" male NPT or
welded copper connections



PEX connections

- A- Type T faucet
- B- RVA-9521-xx-B: 2-way diverter, shared ports
- C- RVA-9521-xx-NS-B: 2-way diverter, non-shared ports
- D- Built-in check-stop valves accessible from the front of the rough-in
- E- Flow rate 1 outlet: 7.9 gpm - 60 psi,
2 outlets: 3.7 gpm - 60 psi

- A- Type T faucet
- B- RVA-9531-xx-B: 3-way diverter, shared ports
- C- RVA-9531-xx-NS-B: 3-way diverter, non-shared ports
- D- Built-in check-stop valves accessible from the front of the rough-in
- E- Flow rate 1 outlet: 7.9 gpm - 60 psi,
2 outlets: 3.7 gpm - 60 psi

- Temperature variation of less than 2 °C / 3.6 °F, making it one of the types of valves with the least temperature variation on the market
- 2 manually adjustable temperature limiting rings included (43 °C / 109 °F and 49 °C / 120 °F)
- Safety temperature stop preset at 38 °C / 100 °F
- Thermostatic/pressure balanced cartridge
- Cartridges included with the rough-in
- Front access, easy-to-change cartridges
- Thicker brass compared to competitors
- Trim installation with a clip plate system (brass plate clipped on a plastic plate)
- Included template for easy installation
- Flat back for easy installation
- Trim depth adjustment range of 1"
- 3 anchor points molded in the rough-in valve for wall mounting
- Lifetime warranty against manufacturing defects

- Temperature variation of less than 2 °C / 3.6 °F, making it one of the types of valves with the least temperature variation on the market
- 2 manually adjustable temperature limiting rings included (43 °C / 109 °F and 49 °C / 120 °F)
- Safety temperature stop preset at 38 °C / 100 °F
- Thermostatic/pressure balanced cartridge
- Cartridges included with the rough-in
- Front access, easy-to-change cartridges
- Thicker brass compared to competitors
- Trim installation with a clip plate system (brass plate clipped on a plastic plate)
- Included template for easy installation
- Flat back for easy installation
- Trim depth adjustment range of 1"
- 3 anchor points molded in the rough-in valve for wall mounting
- Lifetime warranty against manufacturing defects

Rough-in Valves Advantages

3/4" Thermostatic Valve

RVA-3404-00-B

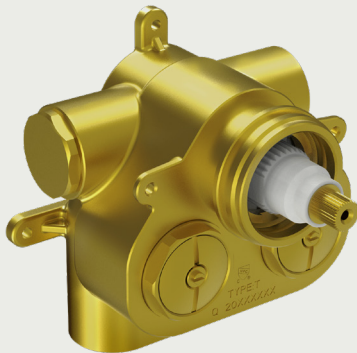

- A- Type T faucet
- B- Built-in check valves
- C- Built-in reversible check-stop valves with filters accessible from the front of the rough-in
- D- Water flow of 16 gpm if direct connection on 3/4" copper - 60 psi

- Temperature variation of less than 2 °C / 3.6 °F, making it one of the types of valves with the least temperature variation on the market
- Manually adjustable temperature limiting device
- Thermostatic cartridge
- Cartridge included with the rough-in
- Front access, easy-to-change cartridge
- Thicker brass compared to competitors
- Included template for easy installation
- Flat back for easy installation
- Trim depth adjustment range of 1"
- Wall mounting anchor points molded in the rough-in valve
- Can easily supply 3 accessories
- 3/4" female NPT connections
- Safety temperature stop, preset at 38 °C / 100 °F
- Must use with separate stop/volume control
- Lifetime warranty against manufacturing defects

3/4" Thermostatic Valve

RVA-3453-00-B

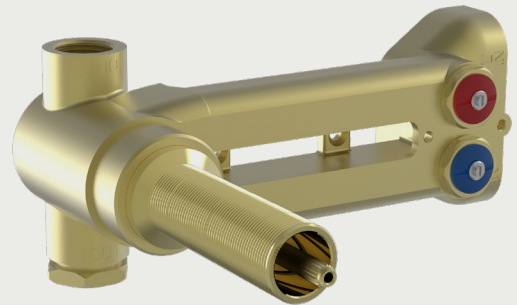

- A- Type T faucet
- B- Built-in check valves
- C- Built-in reversible check-stop valves with filters accessible from the front of the rough-in
- D- Water flow of 9 gpm if direct connection on 3/4" copper - 60 psi

- Temperature variation of less than 2 °C / 3.6 °F, making it one of the types of valves with the least temperature variation on the market
- Manually adjustable temperature limiting device
- Thermostatic cartridge
- Cartridge included with the rough-in
- Front access, easy-to-change cartridge
- Thicker brass compared to competitors
- Included template for easy installation
- Flat back for easy installation
- Trim depth adjustment range of 1"
- Wall mounting anchor points molded in the rough-in valve
- Can easily supply 3 accessories
- 3/4" female NPT connections
- Must use with separate stop/volume control
- Lifetime warranty against manufacturing defects

The thermostatic shower valve must be installed with a volume control valve for each accessory it supplies.

The thermostatic valve can also be used with a 2-port or 3-port diverter with off.

Rough-in Valves Advantages

2-port Diverter Rough Valve with Off

RVA-9562-00-B / RVA-9562-00-NS-B



- A- Can replace 2 volume control valves
- B- RVA-9562-xx-B: 2-way diverter, shared ports
- C- RVA-9562-xx-NS-B: 2-way diverter, non-shared ports
- D- Extra long cartridge for maximum adjustment
- E- Water flow of 10.5 gpm - 60 psi

- Cartridge included with the rough-in
- Front access, easy-to-change cartridge
- Thicker brass compared to competitors
- Flat back for easy installation
- 2 anchor points molded in the rough-in valve for wall-mounting
- Lifetime warranty against manufacturing defects

3-port Diverter Rough Valve with Off

RVA-9563-00-B / RVA-9563-00-NS-B

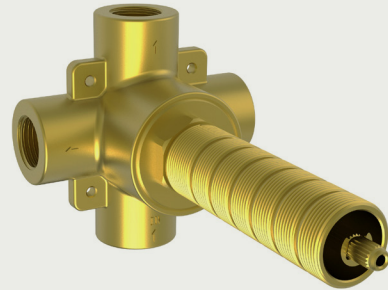

- A- Can replace 3 volume control valves
- B- RVA-9563-xx-B: 3-way diverter, shared ports
- C- RVA-9563-xx-NS-B: 3-way diverter, non-shared ports
- D- Extra long cartridge for maximum adjustment
- E- Water flow of 9.7 gpm - 60 psi

- Cartridge included with the rough-in
- Front access, easy-to-change cartridge
- Thicker brass compared to competitors
- Flat back for easy installation
- 4 anchor points molded in the rough-in valve (2 on each side) for wall mounting
- Lifetime warranty against manufacturing defects

Rough-in Valves Advantages

FEATURES AND BENEFITS	PRESSURE BALANCED	THERMOSTATIC	THERMOSTATIC / PRESSURE BALANCED
Allows temperature limitation at 49 °C	×	×	×
Stabilizes water temperature if the pressure drops up to 50%	×		×
Stabilizes water temperature if the pressure drops up to 20%	×	×	×
Presetting of temperature		×	×
Does not require a direct water connection to the water heater	×		×
Flow - 60 psi	5 to 6 gpm	9 to 16 gpm	7.9 gpm
Allows connection of 3 accessories	×	×	×
Allows connection of more than 3 accessories		×	
Allows the use of 2 accessories at the same time	×	×	×
Allows the use of more than 2 accessories at the same time		×	

Rough-in Valves Advantages

VALVE TYPE	PRESSURE BALANCED	PRESSURE BALANCED + 2-WAY DIVERTER	PRESSURE BALANCED + 3-WAY DIVERTER
ABBREVIATION	REGULAR PB	2-WAY PB	3-WAY PB
Photo			
Code	B66-9120-00-CC	B66-9181-00-CC	B66-9190-00-CC
High flow	+	+	+
Available flow - 60 psi	6 gpm	5 gpm	5 gpm
Collection handle	×	×	×
Connection of 2 accessories	×	×	×
Connection of 3 accessories			×
Connection of tub spout possible	×	×	×
Allows the use of 2 accessories at the same time		×	×
Presetting of temperature			
Easy installation	×	×	×

Rough-in Valves Advantages

THERMOSTATIC / PRESSURE BALANCED + 2-WAY DIVERTER	THERMOSTATIC / PRESSURE BALANCED + 3-WAY DIVERTER	3/4" THERMOSTATIC + VOLUME CONTROL VALVE OR DIVERTER	3/4" THERMOSTATIC + VOLUME CONTROL VALVE OR DIVERTER
2-WAY TP	3-WAY TP	3/4" THERMO	3/4" THERMO
			
B66-9521-00-CC	B66-9531-00-CC	B66-9404-00-CC	B66-9453-00-CC
++	++	+++	+++
7.9 gpm	7.9 gpm	16 gpm	9 gpm
×	×	×	×
×	×	×	×
	×	×	×
×	×	×	×
×	×	×	×
×	×	×	×
×	×		

35 years of craftmanship

Established in 1986, BARIL is still run by the Baril family and thrives to answer your every need in faucet material. Our collections are created with originality, audacity and great quality.

BARILDESIGN.COM

Our Story

1986

Foundation of JL Baril Inc.

JL for the two founders:
J for Jacques Baril
L for Louise Thibeault

JL Baril now offers high-quality products on the Canadian market.



Les distributions
JL Baril inc.



1992

Head office

moves to Trois-Rivieres.

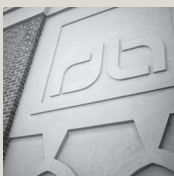

1997

Thermostatic valve

JLB was one of the first companies to integrate thermostatic valves in the North American market.



1989

Exclusive association and launching of the Michel Robichaud Collection

The first faucet collection signed by a famous designer.



1996

Set up of the assembly line at the Trois-Rivieres factory

Distributions JL Baril becomes manufacturer: JL Baril.



2009

Marie-Eve & Jean-Sebastien Baril become the new managers.

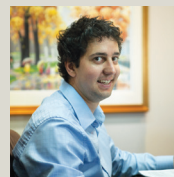

2012

BARIL has new premises

A new location in Montreal — a showroom and a design studio — opens its doors in the heart of the action right on Saint-Laurent Boulevard.



2014

BARIL grows

Expansion of the assembly plant in Trois-Rivières.



2021

FLORA B47

This collection distinguishes itself by the multiple installation options, as well as the customizable handles, offering over 100 finish combinations. Entirely designed in Quebec, FLORA stands out and wins several Design awards locally and internationally.



reddot winner 2022



2012

Design Collections

Four new collections, including MA, are developed in Quebec with a Quebec designer. A new milestone in the Quebec faucet industry, the collection won a Grand Prix du Design.



2017

ANGLE

Launch of the ANGLE kitchen faucet. An immediate favorite in the design world, it won a Grands Prix du Design.



2022

BARIL turns 35 and celebrates with the MARIE B35 collection

This partnership was born from the encounter between Marie-Eve Baril and Marie Saint Pierre joined forces to create a collection that pushes the boundaries of creativity and design and was awarded several times.



reddot winner 2023
best of the best



Electronic

BARIL

TOUCHLESS SENSOR

ELE-1001-01-xx



CC	SS	KK	LL	BB	YY	VV/TT	KM	GG
1000	1300	1300	1400	1350	1300	1450	1450	1500

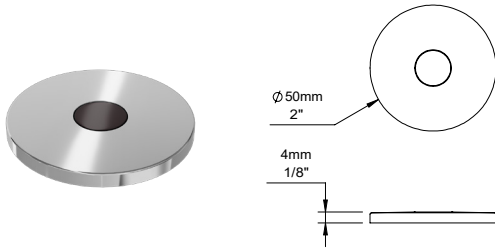

Touchless infrared sensor to turn on and off the water flow of your BARIL faucet with a simple hand movement

- A- Separate mounting for optimal compatibility with the BARIL product line
- B- Installation kits included for both countertop mounting (max 2" countertop thickness) and wall mounting (max 2" wall thickness)
- C- Fast response
- D- 15° detection angle
- E- Adjustable detection range between 2" and 9-7/8" (preset at 2")
- F- Automatic shut-off after 3 minutes
- G- Electronic control valve is concealed in a ready-to-use housing that can be easily installed under the counter
- H- 5-year warranty*
- I- Batteries included (6 x AA)



Compatible with:

KITCHEN FAUCET

WITH PULL-DOWN SPRAY

CUI-1940-02L
CUI-2040-02L
CUI-2040-35L
CUI-9245-02L
CUI-9246-02L
CUI-9247-02L
CUI-9248-02L
CUI-9249-X2L
CUI-9250-X2L
CUI-9335-02L
CUI-9340-02L
CUI-9345-02L
CUI-9350-02L
CUI-9352-02L
CUI-9355-02L
CUI-9540-35L

ATTENTION! Two options available:



ELE-1001-01-xx (p. 42)



ELE-2001-01-xx (p. 43)

Look for these icons in the catalog to identify the compatible option for the selected product.

Finishes:

CC = chrome, KK = matte black, LL = satin brass, BB = white, KM = black titanium, YY = polished nickel, TT = venetian bronze, VV = satin copper, GG = gold, SS = stainless steel

TOUCHLESS SENSOR

ELE-2001-01-xx



CC	SS	KK	LL	BB	NN/YY	VV/TT	KM	II	JJ	EE	HH	GG
1100	1430	1430	1540	1485	1430	1595	1595	1540	1540	1540	1540	1650

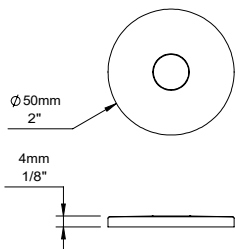
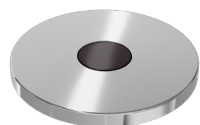

Touchless infrared sensor to turn on and off the water flow of your BARIL faucet with a simple hand movement

- A- Separate mounting for optimal compatibility with the BARIL product line
- B- Installation kits included for both countertop mounting (max 2" countertop thickness) and wall mounting (max 2" wall thickness)
- C- Fast response
- D- 15° detection angle
- E- Adjustable detection range between 2" and 9-7/8" (preset at 2")
- F- Automatic shut-off after 3 minutes
- G- Electronic control valve is concealed in a ready-to-use housing that can be easily installed under the counter
- H- 5-year warranty*
- I- Batteries included (6 x AA)



Compatible with:

KITCHEN FAUCET

LAVATORY FAUCET

WITHOUT PULL-DOWN SPRAY	SINGLE-HOLE	WALL-MOUNTED	DECK-MOUNTED
CUI-2030-02L-xx	B04-1005-XXL-xx	B04-8100-00L-xx	B04-8009-00L-xx
CUI-9181-47L-xx	B04-1020-00L-xx	B04-8120-00L-xx	B05-8009-00L-xx
CUI-9380-02L-xx	B05-1005-XXL-xx	B05-8100-00L-xx	B14-8009-00L-xx
	B05-1010-XXL-xx	B16-8041-00L-xx	B16-8001-01L-xx
	B05-1015-XXL-xx	B18-8041-00L-xx	B18-8001-00L-xx
	B05-1020-00L-xx	B35-8100-00L-xxxx	B26-8000-00L-CD
	B14-1010-XXL-xx	B45-8100-04L-xx	B27-8000-00L-xx
	B14-1020-00L-xx	B46-8100-04L-xx	B28-8000-00L-xx
	B45-1005-XXL-xx	B47-8100-00L-xx	B35-1020-00L-xKx
	B45-1010-XXL-xx	B51-8100-00L-xx	B35-8009-00L-xxxx
	B45-1020-00L-xx	B66-8100-02L-xx	B45-8009-00L-xx
	B46-1010-XXL-xx	B66-8100-04L-xx	B46-8009-00L-xx
	B46-1020-00L-xx	B66-8120-04L-xx	B47-1080-00L-xx
	B46-1030-XXL-xx	B71-8041-00L-xx	B47-8009-00L-xx
	B46-1035-00L-xx	B72-8041-00L-xx	B56-8009-00L-xx
	B46-1040-00L-xx	B74-8041-00L-xx	B66-8009-00L-xx
	B51-1010-XXL-xx	B80-8042-00L-xx	B66-8029-00L-xx
	B56-1010-XXL-xx	B80-8102-00L-xx	B71-8001-01L-xx
	B66-1005-XXL-xx		B72-8001-01L-xx
	B66-1010-XXL-xx		B80-8001-1PL-xx
	B66-1020-00L-xx		B80-8002-1PL-xx
	B66-1030-00L-xx		B80-8003-1PL-xx
	B80-1031-XXL-xx		
	B80-1032-XXL-xx		
	MON-2600-00L-xx		

Finishes:

CC = chrome, KK = matte black, LL = satin brass, BB = white, KM = black titanium, NN = brushed nickel, YY = polished nickel, TT = venetian bronze, VV = satin copper, GG = gold, SS = stainless steel, EE = glossy black, II = mist, JJ = french gold, HH = blush

*More details in the complete warranty.

Kitchen

BARIL

KITCHEN



ANGLE
CUI-1940-02L-xx



UNICK III
CUI-2030-02L-xx



UNICK II
CUI-2040-02L-xx



UNICK II
CUI-2040-35L-xx



TECH IV
CUI-9181-47L-xx



VISION-H15
CUI-9245-02L-xx



VISION II-H15
CUI-9246-02L-xx



VISION-H13
CUI-9247-02L-xx



VISION II-H13
CUI-9248-02L-xx



VISION III
CUI-9249-12L-xx



VISION III
CUI-9249-22L-xx



VISION III
CUI-9249-32L-xx

KITCHEN



VISION IV
CUI-9250-12L-xx



VISION IV
CUI-9250-22L-xx



VISION IV
CUI-9250-32L-xx



ARTE-H19
CUI-9335-02L-xx



ARTE-H16
CUI-9340-02L-xx



ARTE-H13
CUI-9345-02L-xx



TUBE-H15
CUI-9350-02L-xx



TUBE-H13
CUI-9352-02L-xx



TUBE II
CUI-9355-02L-xx



TECH VI
CUI-9380-02L-xx



UNICK
CUI-9540-35L-xx

KITCHEN

FAUCET FOR WATER FILTRATION SYSTEM



ARTE
CUI-4093-00L-xx



UNICK
CUI-4095-00L-xx

POT FILLER

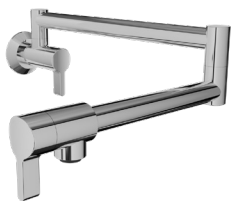

ARTE
CUI-4293-00L-xx

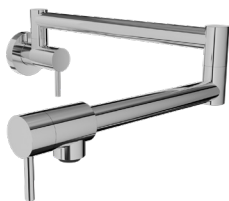

UNICK
CUI-4295-00L-xx

KITCHEN

Compatible with the Touchless Sensor
Order ELE-1001-01-xx (p. 42)
or ELE-2001-01-xx (p. 43)



BARIL

KITCHEN

CUI-1940-02L-xx



CC	SS	KK
1266	1646	1646



GRANDS
PRIX
DU DESIGN

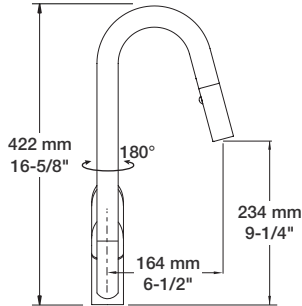

ANGLE

Single-hole kitchen faucet with 2-function pull-down spray

- A- 2-function anti-limestone brass spray with automatic docking
- B- Super Swivel hose connection
- C- 180° swivel spout
- D- CAR-1025-09
- E- Hose: BOY-6018-QC
- F- Spray: DOU-6033-M2-xx

Ecological options

Codes	Reduced flow rates
CUI-1940-02L-xx-150	1.5 gpm (5.7 l/min) - 60 psi
CUI-1940-02L-xx-175	1.75 gpm (6.6 l/min) - 60 psi



CUI-2030-02L-xx



CC	SS
553	719

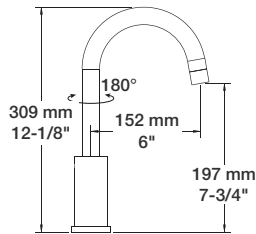

UNICK III

Single-hole bar / prep kitchen faucet with dual spray

- A- 2-function aerator: switch from aerated stream to spray stream by turning the end of the spout
- B- 180° swivel spout
- C- CAR-1031-49

CUI-2040-02L-xx



CC	SS	KK	LL	BB	YY	VV/TT	GG
595	773	773	892	892	773	952	1309

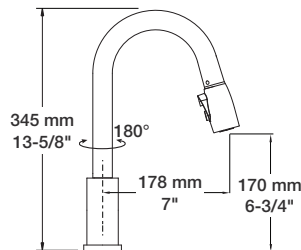

UNICK II

Single-hole bar / prep kitchen faucet with 2-function pull-down spray

- A- 2-function spray
- B- 180° swivel spout
- C- CAR-1031-49
- D- Hose: BOY-6017-QC
- E- Spray: DOU-6071-02-xx

Ecological options

Codes	Reduced flow rates
CUI-2040-02L-xx-150	1.5 gpm (5.7 l/min) - 60 psi

Actual products may differ from pictures. Actual products measures may differ from the measures shown. All USD prices are subject to change without notice. Effective as of August 2023.

CUI-2040-35L-xx



CC	SS	KK	LL	BB	YY	VV/TT	GG
645	839	839	968	968	839	1032	1419

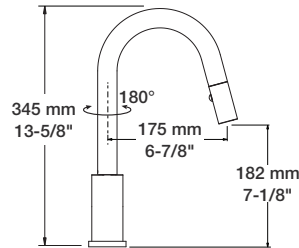

UNICK II

Single-hole bar / prep kitchen faucet with 2-function pull-down spray

- A- 2-function anti-limestone brass spray
- B- 180° swivel spout
- C- CAR-1031-49
- D- Hose: BOY-6017-QC
- E- Spray: DOU-6035-02-xx

Ecological options

Code	Reduced flow rates
CUI-2040-35L-xx-150	1.5 gpm (5.7 l/min) - 60 psi

CUI-9181-47L-xx



CC	SS
843	1096

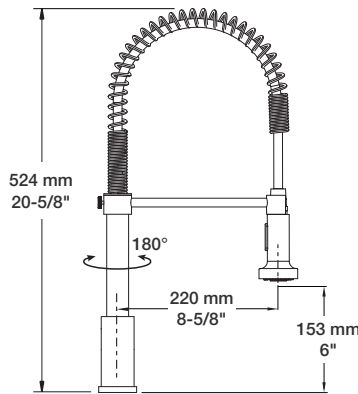

TECH IV

Industrial style single-hole kitchen faucet with 2-function spray

- A- 2-function anti-limestone spray
- B- 180° swivel spout
- C- CAR-1031-49
- D- Spray: DOU-6047-03-xx

Ecological options

Codes	Reduced flow rates
CUI-9181-47L-xx-150	1.5 gpm (5.7 l/min) - 60 psi
CUI-9181-47L-xx-175	1.75 gpm (6.6 l/min) - 60 psi



THE ESSENTIALS

CUI-9245-02L-xx



CC	SS	KK	LL	BB	YY	VV/TT	GG
995	1294	1294	1493	1493	1294	1592	2189

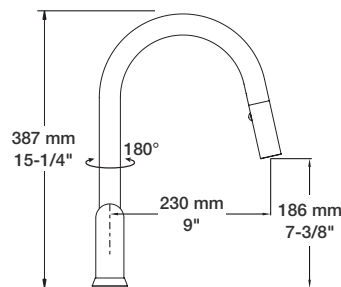

VISION-H15

Single-hole kitchen faucet with 2-function pull-down spray

- A- 2-function anti-limestone brass spray with automatic docking
- B- Super Swivel hose connection
- C- 180° swivel spout
- D- CAR-1025-09
- E- Hose: BOY-6018-QC
- F- Spray: DOU-6033-M2-xx

Ecological options

Codes	Reduced flow rates
CUI-9245-02L-xx-150	1.5 gpm (5.7 l/min) - 60 psi
CUI-9245-02L-xx-175	1.75 gpm (6.6 l/min) - 60 psi



Finishes:

CC = chrome, KK = matte black, LL = satin brass, BB = white, KM = black titanium, YY = polished nickel, TT = venetian bronze, VV = satin copper, GG = gold, SS = stainless steel, KL = matte black and satin brass, SK = stainless steel and matte black, CK = chrome and matte black, LK = satin brass and matte black

KITCHEN

CUI-9246-02L-xx



KL	LK	SK
1584	1584	1368

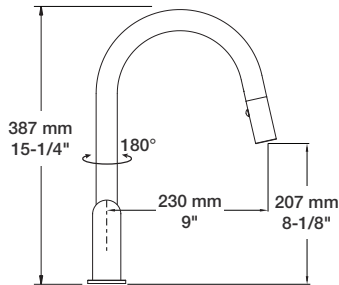

VISION II-H15

Single-hole kitchen faucet with 2-function pull-down spray

- A- Two-tone finishes: faucet body in KK, LL or SS, handle stick and spray in KK or LL
- B- 2-function anti-limestone brass spray with automatic docking
- C- Super Swivel hose connection
- D- 180° swivel spout
- E- CAR-1025-09
- F- Hose: BOY-6018-QC
- G- Spray: DOU-6030-M2-xx

Ecological options

Codes	Reduced flow rates
CUI-9246-02L-xx-150	1.5 gpm (5.7 l/min) - 60 psi
CUI-9246-02L-xx-175	1.75 gpm (6.6 l/min) - 60 psi

CEC

THE ESSENTIALS

CUI-9247-02L-xx



CC	SS	KK	LL	BB	YY	VV/TT	GG
925	1203	1203	1388	1388	1203	1480	2035

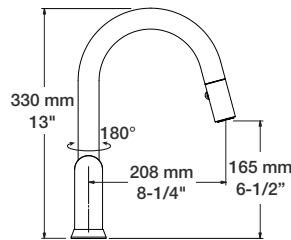

VISION-H13

Single-hole bar / prep kitchen faucet with 2-function pull-down spray

- A- 2-function anti-limestone brass spray with automatic docking
- B- Super Swivel hose connection
- C- 180° swivel spout
- D- CAR-1025-09
- E- Hose: BOY-6018-QC
- F- Spray: DOU-6030-M2-xx

Ecological options

Codes	Reduced flow rates
CUI-9247-02L-xx-150	1.5 gpm (5.7 l/min) - 60 psi
CUI-9247-02L-xx-175	1.75 gpm (6.6 l/min) - 60 psi

CEC

CUI-9248-02L-xx



KL	SK
1584	1368

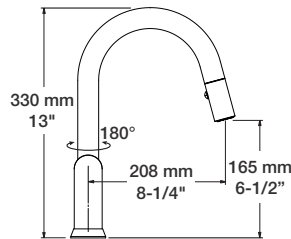

VISION II-H13

Single-hole bar / prep kitchen faucet with 2-function pull-down spray

- A- Two-tone finishes: faucet body in KK or SS, handle stick and spray in KK or LL
- B- 2-function anti-limestone brass spray with automatic docking
- C- Super Swivel hose connection
- D- 180° swivel spout
- E- CAR-1025-09
- F- Hose: BOY-6018-QC
- G- Spray: DOU-6030-M2-xx

Ecological options

Codes	Reduced flow rates
CUI-9248-02L-xx-150	1.5 gpm (5.7 l/min) - 60 psi
CUI-9248-02L-xx-175	1.75 gpm (6.6 l/min) - 60 psi

CEC

Actual products may differ from pictures. Actual products measures may differ from the measures shown. All USD prices are subject to change without notice. Effective as of August 2023.

CUI-9249-X2L-xx

CUI-9249-12L-xx VISION III



CC	SS	KK	LL
1304	1696	1696	1956

CUI-9249-22L-xx VISION III



CC	SS	KK	LL
1356	1762	1762	2034

CUI-9249-32L-xx VISION III



CC	SS	KK	LL
1253	1629	1629	1879

CUI-9249-12L-KL VISION III



KL
1696

CUI-9249-22L-KL VISION III



KL
1762

CUI-9249-32L-KL VISION III



KL
1629

CUI-9249-12L-xK VISION III



CK	LK	SK
1304	1956	1696

CUI-9249-22L-xK VISION III



CK	LK	SK
1356	2034	1762

CUI-9249-32L-xK VISION III



CK	LK	SK
1253	1879	1629

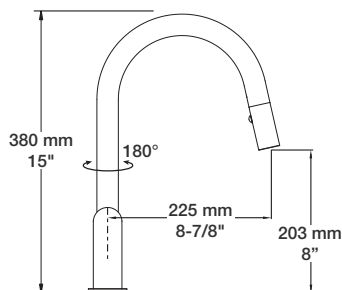

Single-hole kitchen faucet with 2-function pull-down spray

- A- 2-function anti-limestone brass spray with automatic docking
- B- Super Swivel hose connection
- C- 180° swivel spout
- D- CAR-1025-09
- E- Hose: BOY-6018-QC
- F- Spray: CUI-9249-12L-xx: DOU-6039-M2-xx
CUI-9249-22L-xx: DOU-6038-M2-xx
CUI-9249-32L-xx: DOU-6030-M2-xx

Ecological options

Codes	Reduced flow rates
CUI-9249-X2L-xx-150	1.5 gpm (5.7 l/min) - 60 psi
CUI-9249-X2L-xx-175	1.75 gpm (6.6 l/min) - 60 psi



Finishes:

CC = chrome, KK = matte black, LL = satin brass, BB = white, KM = black titanium, YY = polished nickel, TT = venetian bronze, VV = satin copper, GG = gold, SS = stainless steel, KL = matte black and satin brass, SK = stainless steel and matte black, CK = chrome and matte black, LK = satin brass and matte black

KITCHEN

CUI-9250-X2L-xx

CUI-9250-12L-xx VISION IV



CC	SS	KK	LL
1304	1696	1696	1956

CUI-9250-22L-xx VISION IV



CC	SS	KK	LL
1356	1762	1762	2034

CUI-9250-32L-xx VISION IV



CC	SS	KK	LL
1253	1629	1629	1879

CUI-9250-12L-KL VISION IV



KL
1696

CUI-9250-22L-KL VISION IV



KL
1762

CUI-9250-32L-KL VISION IV





KL
1629

CUI-9250-12L-xK VISION IV



CK	LK	SK
1304	1956	1696

CUI-9250-22L-xK VISION IV





CK	LK	SK
1356	2034	1762

CUI-9250-32L-xK VISION IV

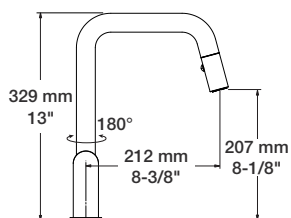

CK	LK	SK
1253	1879	1629



Single-hole kitchen faucet with 2-function pull-down spray

- A- 2-function anti-limestone brass spray with automatic docking
- B- Super Swivel hose connection
- C- 180° swivel spout
- D- CAR-1025-09

- E- Hose: BOY-6018-QC
- F- Spray: CUI-9250-12L-xx: DOU-6039-M2-xx
CUI-9250-22L-xx: DOU-6038-M2-xx
CUI-9250-32L-xx: DOU-6030-M2-xx

Ecological options

Codes	Reduced flow rates
CUI-9250-X2L-xx-150	1.5 gpm (5.7 l/min) - 60 psi
CUI-9250-X2L-xx-175	1.75 gpm (6.6 l/min) - 60 psi



Actual products may differ from pictures. Actual products measures may differ from the measures shown. All USD prices are subject to change without notice. Effective as of August 2023.

CUI-9335-02L-xx



CC	SS	KK	LL	BB	YY	VV/TT	KM	GG
1254	1630	1630	1881	1881	1630	2006	2006	2759

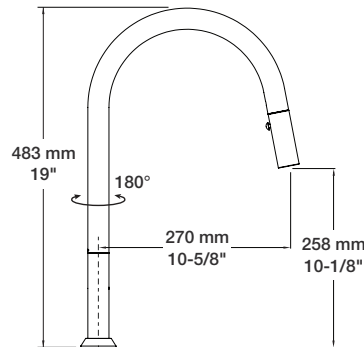

ARTE-H19

High single-hole kitchen faucet with 2-function pull-down spray

- A- 2-function anti-limestone brass spray with automatic docking
- B- Super Swivel hose connection
- C- 180° swivel spout
- D- CAR-1025-09
- E- Hose: BOY-6018-QC
- F- Spray: DOU-6033-M2-xx

Ecological options

Codes	Reduced flow rates
CUI-9335-02L-xx-150	1.5 gpm (5.7 l/min) - 60 psi
CUI-9335-02L-xx-175	1.75 gpm (6.6 l/min) - 60 psi



THE ESSENTIALS

CUI-9340-02L-xx



CC	SS	KK	LL	BB	YY	VV/TT	KM	GG
995	1294	1294	1493	1493	1294	1592	1592	2189

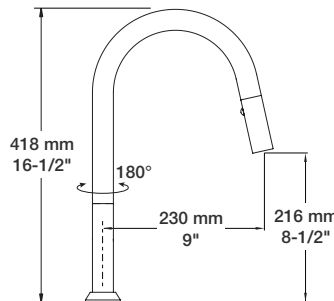

ARTE-H16

High single-hole kitchen faucet with 2-function pull-down spray

- A- 2-function anti-limestone brass spray with automatic docking
- B- Super Swivel hose connection
- C- 180° swivel spout
- D- CAR-1025-09
- E- Hose: BOY-6018-QC
- F- Spray: DOU-6033-M2-xx

Ecological options

Codes	Reduced flow rates
CUI-9340-02L-xx-150	1.5 gpm (5.7 l/min) - 60 psi
CUI-9340-02L-xx-175	1.75 gpm (6.6 l/min) - 60 psi



THE ESSENTIALS

CUI-9345-02L-xx



CC	SS	KK	LL	BB	YY	VV/TT	KM	GG
925	1203	1203	1388	1388	1203	1480	1480	2035

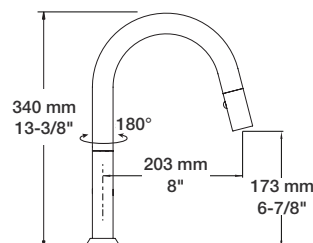

ARTE-H13

Single-hole bar / prep kitchen faucet with 2-function pull-down spray

- A- 2-function anti-limestone brass spray with automatic docking
- B- Super Swivel hose connection
- C- 180° swivel spout
- D- CAR-1025-09
- E- Hose: BOY-6018-QC
- F- Spray: DOU-6030-M2-xx

Ecological options

Codes	Reduced flow rates
CUI-9345-02L-xx-150	1.5 gpm (5.7 l/min) - 60 psi
CUI-9345-02L-xx-175	1.75 gpm (6.6 l/min) - 60 psi



Finishes:

CC = chrome, KK = matte black, LL = satin brass, BB = white, KM = black titanium, YY = polished nickel, TT = venetian bronze, VV = satin copper, GG = gold, SS = stainless steel, KL = matte black and satin brass, SK = stainless steel and matte black, CK = chrome and matte black, LK = satin brass and matte black

KITCHEN

CUI-9350-02L-xx

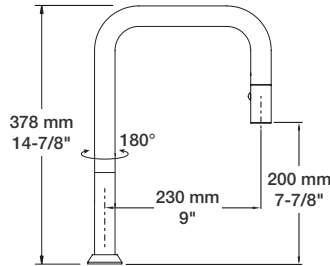

CC	SS	KK	LL	BB	YY	VV/TT	GG
1145	1489	1489	1718	1718	1489	1832	2519

TUBE-H15

Single-hole kitchen faucet with 2-function pull-down spray

- A- 2-function anti-limestone brass spray with automatic docking
- B- Super Swivel hose connection
- C- 180° swivel spout
- D- CAR-1025-09
- E- Hose: BOY-6018-QC
- F- Spray: DOU-6030-M2-xx

Ecological options

Codes	Reduced flow rates
CUI-9350-02L-xx-150	1.5 gpm (5.7 l/min) - 60 psi
CUI-9350-02L-xx-175	1.75 gpm (6.6 l/min) - 60 psi



CUI-9352-02L-xx

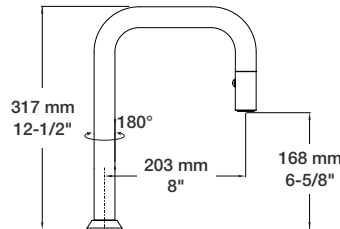

CC	SS	KK	LL	BB	YY	VV/TT	GG
1095	1424	1424	1643	1643	1424	1752	2409

TUBE-H13

Single-hole bar / prep kitchen faucet with 2-function pull-out spray

- A- 2-function anti-limestone brass spray with automatic docking
- B- Super Swivel hose connection
- C- 180° swivel spout
- D- CAR-1025-09
- E- Hose: BOY-6018-QC
- F- Spray: DOU-6030-M2-xx

Ecological options

Codes	Reduced flow rates
CUI-9352-02L-xx-150	1.5 gpm (5.7 l/min) - 60 psi
CUI-9352-02L-xx-175	1.75 gpm (6.6 l/min) - 60 psi



CUI-9355-02L-xx

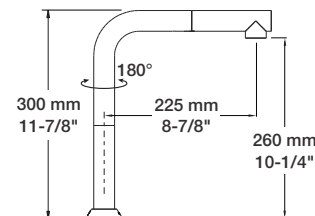

CC	SS	KK	LL	BB	YY	VV/TT	GG
1145	1489	1489	1718	1718	1489	1832	2519

TUBE II

Single-hole kitchen faucet with 2-function pull-out spray

- A- 2-function anti-limestone brass spray
- B- Super Swivel hose connection
- C- 180° swivel spout
- D- CAR-1025-09
- E- Hose: BOY-6019-QC
- F- Spray: DOU-6037-02-xx

Ecological options

Codes	Reduced flow rates
CUI-9355-02L-xx-150	1.5 gpm (5.7 l/min) - 60 psi
CUI-9355-02L-xx-175	1.75 gpm (6.6 l/min) - 60 psi



Actual products may differ from pictures. Actual products measures may differ from the measures shown. All USD prices are subject to change without notice. Effective as of August 2023.

CUI-9380-02L-xx

ADA



CC	SS
1277	1659

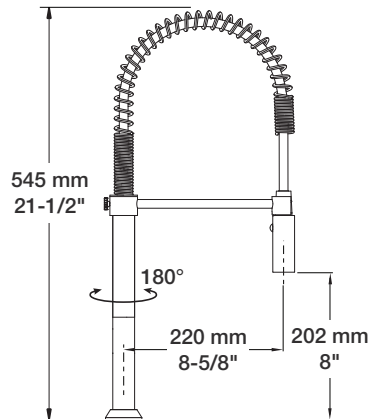

TECH VI

Industrial style single-hole kitchen faucet with 2-function spray

- A- 2-function anti-limestone brass spray
- B- 180° swivel spout
- C- CAR-1025-09
- D- Spray: DOU-6033-02-xx

Ecological options

Codes	Reduced flow rates
CUI-9380-02L-xx-150	1.5 gpm (5.7 l/min) - 60 psi
CUI-9380-02L-xx-175	1.75 gpm (6.6 l/min) - 60 psi

CEC

CUI-9540-35L-xx

ADA



CC	SS	KK	LL	BB	YY	VV/TT	GG
744	967	967	1115	1115	967	1190	1636

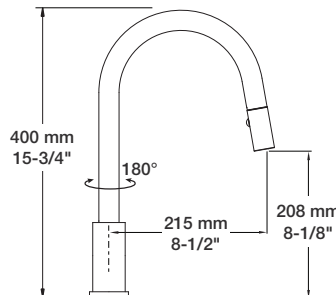

UNICK

Modern single-hole kitchen faucet with single lever and 2-function pull-down spray

- A- 2-function anti-limestone brass spray
- B- 180° swivel spout
- C- CAR-1031-49
- D- Hose: BOY-6017-QC
- E- Spray: DOU-6035-02-xx

Ecological options

Codes	Reduced flow rates
CUI-9540-35L-xx-150	1.5 gpm (5.7 l/min) - 60 psi
CUI-9540-35L-xx-175	1.75 gpm (6.6 l/min) - 60 psi

CEC

THE ESSENTIALS

CUI-4093-00L-xx

ADA

CC	SS	KK	LL	BB	YY	VV/TT	KM	GG
396	515	515	594	594	515	634	634	871

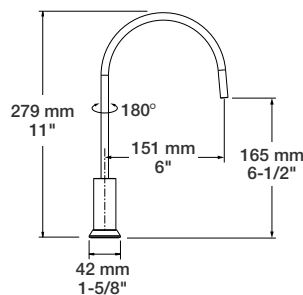

ARTE

Single-hole faucet for water filtration system

- A- Single-hole faucet for water filtration system
- B- Water flow may vary depending on the filtration system - max: 1 gpm
- C- CAR-3820-02
- D- One connection (3/8" or 1/4" - adaptor included)
- E- Filtration system not included
- F- Non-air gap faucet

Finishes:

CC = chrome, KK = matte black, LL = satin brass, BB = white, KM = black titanium, YY = polished nickel, TT = venetian bronze, VV = satin copper, GG = gold, SS = stainless steel, KL = matte black and satin brass, SK = stainless steel and matte black, CK = chrome and matte black, LK = satin brass and matte black

KITCHEN

CUI-4095-00L-xx

ADA

CC	SS	KK	LL	BB	YY	VV/TT	GG
376	489	489	564	564	489	602	827

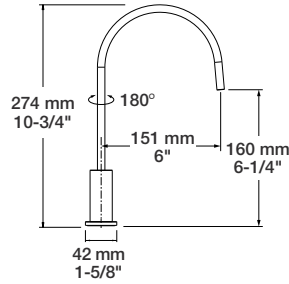

UNICK

Single-hole faucet for water filtration system

- A- Single-hole faucet for water filtration system
- B- Water flow may vary depending on the filtration system - max: 1 gpm
- C- CAR-3820-02
- D- One connection (3/8" or 1/4" - adaptor included)
- E- Filtration system not included
- F- Non-air gap faucet

THE ESSENTIALS

CUI-4293-00L-xx

ADA

CC	SS	KK	LL	BB	YY	VV/TT	KM	GG
1045	1359	1359	1568	1568	1359	1672	1672	2299

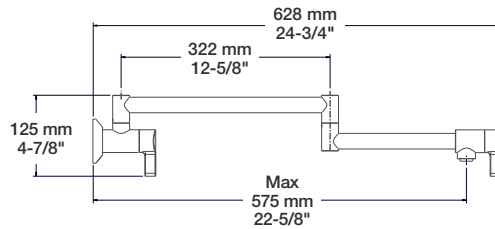
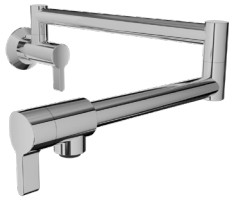

ARTE

Single-hole wall-mounted pot filler with two handles

- A- Max: 2.2 gpm - 60 psi
- B- Two volume control handles: rotate 90° (1/4 turn)
- C- CAR-1020-02 (x2)
- D- Easy-to-clean adjustable silicone aerator
- E- Swivel double-jointed spout extends up to 22-5/8" (575 mm)
- F- Swivel limited to 180° on the wall side
- G- Folds away in a compact way
- H- 1/2" female NPT connection
- I- Cold water supply connection only

Ecological options

Codes	Reduced flow rates
CUI-4293-00L-xx-150	1.5 gpm (5.7 l/min) - 60 psi

CUI-4295-00L-xx

ADA

CC	SS	KK	LL	BB	YY	VV/TT	GG
975	1268	1268	1463	1463	1268	1560	2145

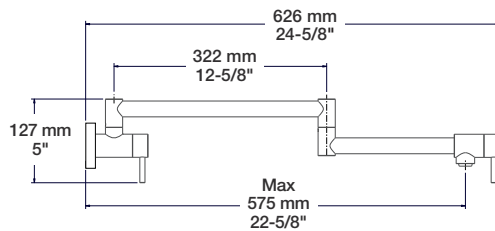
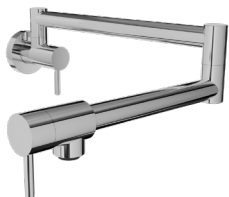

UNICK

Single-hole wall-mounted pot filler with two handles

- A- Max: 2.2 gpm - 60 psi
- B- Two volume control handles: rotate 90° (1/4 turn)
- C- CAR-1020-02 (x2)
- D- Easy-to-clean adjustable silicone aerator
- E- Swivel double-jointed spout extends up to 22-5/8" (575 mm)
- F- Swivel limited to 180° on the wall side
- G- Folds away in a compact way
- H- 1/2" female NPT connection
- I- Cold water supply connection only

Ecological options

Codes	Reduced flow rates
CUI-4295-00L-xx-150	1.5 gpm (5.7 l/min) - 60 psi

Actual products may differ from pictures. Actual products measures may differ from the measures shown. All USD prices are subject to change without notice. Effective as of August 2023.

Parts

BARIL

PARTS

THE ESSENTIALS

DIS-9030-00-xx

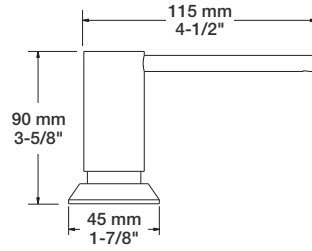

CC	SS	KK	LL	BB	YY	VV/TT	KM	GG
150	195	195	225	225	195	240	240	330

Modern soap dispenser

- A- Custom designed to match BARIL faucets
- B- Made of solid brass, plastic bottle
- C- 4" spout reach
- D- Swivels 360°
- E- 325 ml bottle that fills up from the top
- F- Fits 1-1/4" hole
- G- For counter up to 2" thickness

DIS-9035-00-xx

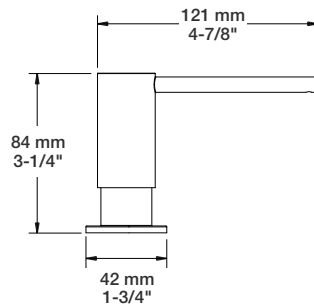

CC	SS	KK	LL	BB	YY	VV/TT	KM	GG
242	314	314	363	363	314	387	532	

Modern soap dispenser

- A- Custom designed to match BARIL faucets
- B- Made of solid brass, plastic bottle
- C- 4" spout reach
- D- Swivels 360°
- E- 325 ml bottle that fills up from the top
- F- Fits 1-1/4" hole
- G- For counter up to 2" thickness

DIS-9040-00-xx

Available Q3 2023

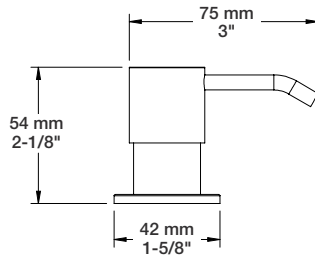

CC	SS	KK	LL	BB	YY	VV/TT	KM	GG
140	182	182	210	210	182	224	224	308

Modern soap dispenser

- A- Custom designed to match BARIL faucets
- B- Made of solid brass, plastic bottle
- C- 2-3/8" spout reach
- D- Swivels 360°
- E- 325 ml bottle that fills up from the top
- F- Fits 1-1/4" hole
- G- For counter up to 2" thickness

CAC-6023-01-xx

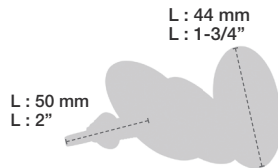

CC	KK	LL	BB	YY	VV/TT	GG
42	55	63	63	55	67	92

Hole cover

- A- For counter up to 1-3/4" thickness

PLA-0813-01-xx

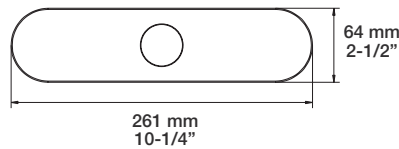

CC	SS	KK	LL	BB	YY	VV/TT	KM	GG
79	103	103	119	119	103	126	126	174

8" c/c faucet hole cover plate

Actual products may differ from pictures. Actual products measures may differ from the measures shown. All USD prices are subject to change without notice. Effective as of August 2023.

PLA-0813-02-xx

CC	KK	LL	BB	YY	VV/TT	GG
79	103	119	119	103	126	174

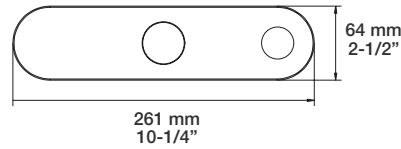

8" c/c faucet hole cover plate with 2 holes
(adapted for soap dispenser)

DOU-6030-M2-xx

CC	SS	KK	LL	BB	YY	VV/TT	KM	GG
226	294	294	339	339	294	361	361	497

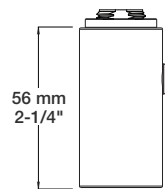

Brass 2-spray hand shower

A- 2-function anti-limestone hand shower

DOU-6033-02-xx

CC	SS	KK	LL	BB	YY	VV/TT	GG
208	270	270	311	311	270	332	457

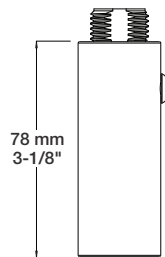

Brass 2-spray hand shower

A- 2-function anti-limestone hand shower

DOU-6033-M2-xx

CC	SS	KK	LL	BB	YY	VV/TT	KM	GG
260	338	338	390	390	338	416	416	572

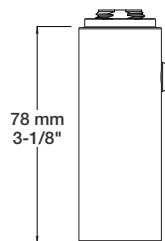

Brass 2-spray hand shower

A- 2-function anti-limestone hand shower

DOU-6035-02-xx

CC	SS	KK	LL	BB	YY	VV/TT	GG
208	270	270	311	311	270	332	457

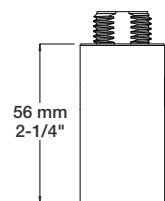

Brass 2-spray hand shower

A- 2-function anti-limestone hand shower

Finishes:

CC = chrome, KK = matte black, LL = satin brass, BB = white, KM = black titanium, YY = polished nickel, TT = venetian bronze, VV = satin copper, GG = gold, SS = stainless steel

PARTS

DOU-6037-02-xx

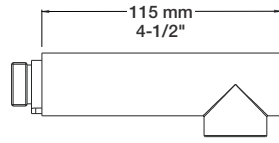

CC	SS	KK	LL	BB	YY	VV/TT	GG
277	360	360	416	416	360	443	610

Brass 2-spray hand shower
A- 2-function anti-limestone hand shower

DOU-6038-M2-xx

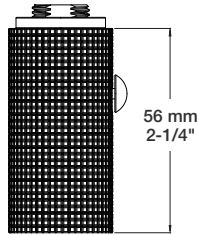

CC	SS	KK	LL
277	360	360	416

Brass 2-spray hand shower
A- 2-function anti-limestone hand shower

DOU-6039-M2-xx

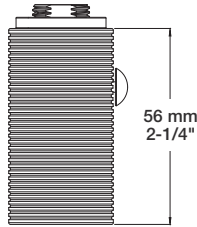

CC	SS	KK	LL
277	360	360	416

Brass 2-spray hand shower
A- 2-function anti-limestone hand shower

DOU-6047-03-xx

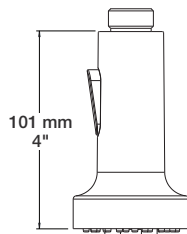

CC	SS	KK	LL	BB	YY	VV/TT	GG
109	142	142	164	164	142	174	240

2-spray hand shower
A- 2-function anti-limestone hand shower

DOU-6070-02-xx



CC	SS	KK	LL	YY	VV/TT	GG
109	142	142	164	142	174	240

2-spray hand shower
A- 2-function anti-limestone hand shower

Actual products may differ from pictures. Actual products measures may differ from the measures shown. All USD prices are subject to change without notice. Effective as of August 2023.

DOU-6071-02-xx



CC	SS	KK	LL	BB	YY	VV/TT	GG
109	142	142	164	164	142	174	240

2-spray hand shower

INA-9030-02-xx

Available Q3 2023

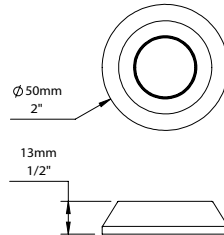

CC	SS	KK	LL	BB	YY	VV/TT	KM	GG
395	514	514	593	593	514	632	632	869

ARTE air switch

- A- Custom designed to match BARIL faucets
- B- Pressing the air switch will alternately turn on or off two devices
- C- Control box included
- D- Trim made from solid brass

INA-9035-02-xx

Available Q3 2023

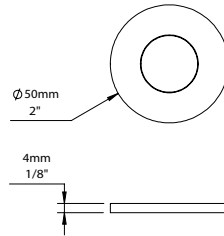

CC	SS	KK	LL	BB	YY	VV/TT	GG
395	514	514	593	593	514	632	869

UNICK air switch

- A- Custom designed to match BARIL faucets
- B- Pressing the air switch will alternately turn on or off two devices
- C- Control box included
- D- Trim made from solid brass

REN-6035-01-xx

Available Q3 2023



CC	SS	KK	LL	KM
115	150	150	173	184

Kitchen sink drain with strainer

- A- High-quality basket strainer prevents food particles and residue from clogging the drain
- B- Removable deep wastebasket
- C- Sink strainer fits perfectly in any sink with a 3-1/2" (8.9 cm) opening
- D- All stainless steel construction

Finishes:

CC = chrome, KK = matte black, LL = satin brass, BB = white, KM = black titanium, YY = polished nickel, TT = venetian bronze, VV = satin copper, GG = gold, SS = stainless steel

Bathroom

BARIL

BATHROOM



PETITE B04
B04-1005-1PL-xx



REC B05
B05-1005-1PL-xx



OVAL B14
B14-1010-1PL-xx



NAUTICA B16
B16-8001-01L-xx



RALPH B18
B18-8001-00L-xx



HAÜS-D B26
B26-8000-00L-xx



HAÜS-C B27
B27-8000-00L-xx



HAÜS-L B28
B28-8000-00L-xx



MARIE B35
B35-8009-00L-xxxx



SENS B45
B45-1010-1PL-xx



PROFILE B46
B46-1010-1PL-xx



FLORA B47
B47-8009-00L-xx

BATHROOM



MA B51
B51-1010-1PL-xx



ACCENT B56
B56-1010-1PL-xx



ZIP B66
B66-1010-1PL-xx



EVA B71
B71-8001-01L-xx



TRADITION B72
B72-8001-01L-xx



VICTOIRE B74
MON-2600-00L-xx



AIR B80
B80-8009-00L-xx

PETITE B04

Compatible with the Touchless Sensor
Order ELE-2001-01-xx (p. 43)



PETITE B04

THE ESSENTIALS

B04-1005-1PL-xx

DRAIN INCLUDED

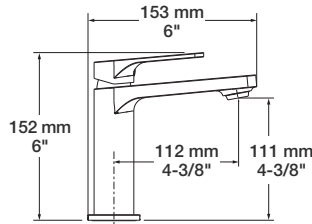

CC	KK	LL	BB	NN/YY	VV/TT	KM	GG
510	663	765	765	663	816	816	1122

Single-hole lavatory faucet, drain included

- A- Max: 1.5 gpm - 60 psi
- B- Easy-to-clean adjustable silicone aerator
- C- CAR-1025-06
- D- Push-button drain with overflow included

Ecological options

Codes	Reduced flow rates	CEC
B04-1005-XXL-xx-120	1.2 gpm (4.5 l/min) - 60 psi	
B04-1005-XXL-xx-100	1.0 gpm (3.7 l/min) - 60 psi	
B04-1005-XXL-xx-050	0.5 gpm (1.9 l/min) - 60 psi	

DRAIN NOT INCLUDED

B04-1005-00L-xx

D- Order your lavatory drain (pages 309-310)

CC	KK	LL	BB	NN/YY	VV/TT	KM	GG
462	600	693	693	600	739	739	1011

B04-1020-00L-xx

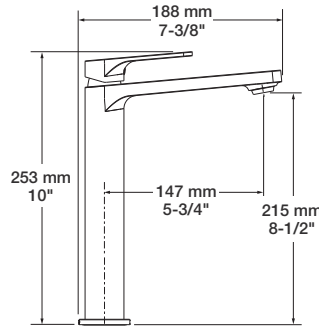

CC	KK	LL	BB	NN/YY	VV/TT	KM	GG
756	983	1135	1135	983	1210	1210	1664

High single-hole lavatory faucet, drain not included

- A- Max: 1.5 gpm - 60 psi
- B- Order your lavatory drain (pages 309-310)
- C- Easy-to-clean adjustable silicone aerator
- D- CAR-1025-06

Ecological options

Codes	Reduced flow rates	CEC
B04-1020-00L-xx-120	1.2 gpm (4.5 l/min) - 60 psi	
B04-1020-00L-xx-100	1.0 gpm (3.7 l/min) - 60 psi	
B04-1020-00L-xx-050	0.5 gpm (1.9 l/min) - 60 psi	

THE ESSENTIALS

B04-8009-00L-xx

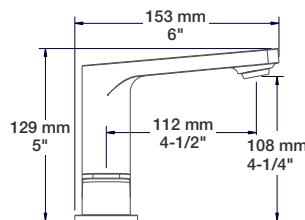

CC	KK	LL	BB	NN/YY	VV/TT	KM	GG
851	1106	1276	1276	1106	1361	1361	1871

8" c/c lavatory faucet, drain included

- A- Max: 1.5 gpm - 60 psi
- B- Push-button drain with overflow included
- C- Easy-to-clean adjustable silicone aerator
- D- CAR-3820-01 (Cold), CAR-3820-02 (Hot)

Ecological options

Codes	Reduced flow rates	CEC
B04-8009-00L-xx-120	1.2 gpm (4.5 l/min) - 60 psi	
B04-8009-00L-xx-100	1.0 gpm (3.7 l/min) - 60 psi	
B04-8009-00L-xx-050	0.5 gpm (1.9 l/min) - 60 psi	

Actual products may differ from pictures. Actual products measures may differ from the measures shown. All USD prices are subject to change without notice. Effective as of August 2023.

PETITE B04

THE ESSENTIALS

B04-8100-00L-xx

COMPLETE FAUCET

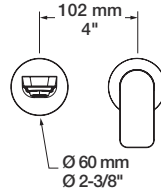
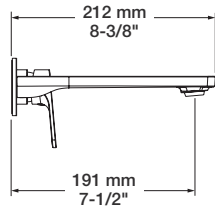

CC	KK	LL	BB	NN/YY	VV/TT	KM	GG
814	977	1221	1221	977	1302	1302	1791

Single lever wall-mounted lavatory faucet, drain not included

- A- 1.5 gpm - 60 psi
- B- Order your lavatory drain (pages 309- 310)
- C- Easy-to-clean adjustable silicone aerator
- D- One-piece rough for easy installation
- E- Large depth adjustment range
- F- CAR-1025-09

Ecological options

Codes	Reduced flow rates
B04-8100-00L-xx-120	1.2 gpm (4.5 l/min) - 60 psi
B04-8100-00L-xx-100	1.0 gpm (3.7 l/min) - 60 psi
B04-8100-00L-xx-050	0.5 gpm (1.9 l/min) - 60 psi

CEC

TRIM ONLY

T04-8100-00L-xx

CC	KK	LL	BB	NN/YY	VV/TT	KM	GG
472	635	879	879	635	960	960	1449

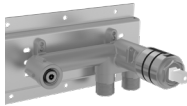

ROUGH Please order the following rough to complete the trim:

ROU-8100-04-B

Single lever wall-mounted lavatory rough - 1/2" male NPT or welded copper connections

342

PETITE B04

B04-8120-00L-xx

COMPLETE FAUCET

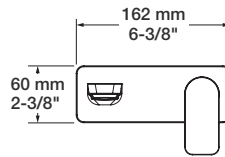
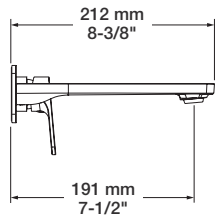

CC	KK	LL	BB	NN/YY	VV/TT	KM	GG
950	1235	1425	1425	1235	1520	1520	2090

Single lever wall-mounted lavatory faucet, drain not included

- A- 1.5 gpm - 60 psi
- B- Order your lavatory drain (pages 309- 310)
- C- Easy-to-clean adjustable silicone aerator
- D- One-piece rough with wall plate for easy installation
- E- Large depth adjustment range
- F- CAR-1025-09

Ecological options

Codes	Reduced flow rates
B04-8120-00L-xx-120	1.2 gpm (4.5 l/min) - 60 psi
B04-8120-00L-xx-100	1.0 gpm (3.7 l/min) - 60 psi
B04-8120-00L-xx-050	0.5 gpm (1.9 l/min) - 60 psi

CEC

TRIM ONLY

T04-8120-00L-xx

CC	KK	LL	BB	NN/YY	VV/TT	KM	GG
608	893	1083	1083	893	1178	1178	1748



ROUGH Please order the following rough to complete the trim:

ROU-8100-04-B

Single lever wall-mounted lavatory rough - 1/2" male NPT or welded copper connections

342

Finishes:

CC = chrome, KK = matte black, LL = satin brass, BB = white, NN = brushed nickel, YY = polished nickel, TT = venetian bronze, VV = satin copper, KM = black titanium, GG = gold

PETITE B04

THE ESSENTIALS

B04-1100-00-xx

COMPLETE FAUCET **ADA**

CC	KK	LL	BB	NN/YY	VV/TT	KM	GG
2282	2739	3423	3423	2967	3652	3652	5021

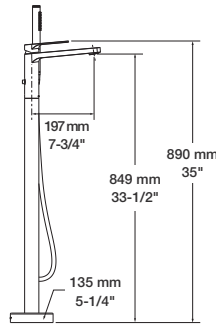

Floor-mounted tub filler with hand shower

Bath spout:

- A- 7.1 gpm - 60 psi
- B- Tub spout with integrated push-button diverter

Hand shower:

- C- Max: 2 gpm - 80 psi
- D- Reclining hand shower holder
- E- Built-in hook on the hand shower holder
- F- Hand shower DOU-2604-01-xx with 59" hose
- G- CAR-1031-49
- H- PVC hose in KK finish or brass for other finishes

Ecological options

Codes	Reduced flow rates
B04-1100-00-xx-150	1.5 gpm (5.7 l/min) - 80 psi
B04-1100-00-xx-175	1.75 gpm (6.6 l/min) - 80 psi

TRIM ONLY

T04-1100-00-xx

CC	KK	LL	BB	NN/YY	VV/TT	KM	GG
2147	2604	3288	3288	2832	3517	3517	4886



MOUNTING KIT Please order the following kit to complete the trim:

FIX-1100-00-B

Floor mounting kit for floor-mounted tub filler with hand shower

135

B04-1249-00-xx

THE ESSENTIALS

CC	KK	LL	BB	NN/YY	VV/TT	KM	GG
1150	1495	1725	1725	1495	1840	1840	2531

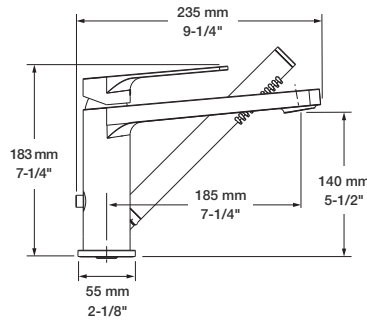

2-piece tub filler with hand shower

Bath spout:

- A- 7.3 gpm - 60 psi
- B- Tub spout with integrated push-button diverter

Hand shower:

- C- Max: 2 gpm - 80 psi
- D- Non-conductive brass hand shower
- E- Easy-to-clean anti-limestone hand shower
- F- DOU-2604-01-xx
- G- CAR-1031-49

Ecological options

Codes	Reduced flow rates
B04-1249-00-xx-150	1.5 gpm (5.7 l/min) - 80 psi
B04-1249-00-xx-175	1.75 gpm (6.6 l/min) - 80 psi

B04-9100-00-xx

ROUGH & TRIM PACKAGE

CC	KK	LL	BB	NN/YY	VV/TT	GG
645	746	813	813	746	846	1047

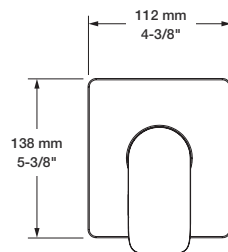

Complete pressure balanced shower control valve

- A- 6 gpm - 60 psi
- B- Volume control valve
- C- Thin brass plate
- D- CAR-1020-40
- E- Rough valve RVA-9020-00-B included

TRIM ONLY

T04-9139-00-xx

CC	KK	LL	BB	NN/YY	VV/TT	GG
335	436	503	503	436	536	737

ROUGH VALVES Please order **one** of the following rough valves to complete the trim:

RVA-9020-00-B

Type P rough - 1/2" male NPT or welded copper connections

310

RVA-9020-PO-B

Type P rough - PEX connections

310

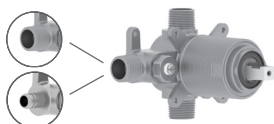

Actual products may differ from pictures. Actual products measures may differ from the measures shown. All USD prices are subject to change without notice. Effective as of August 2023.

PETITE B04

THE ESSENTIALS

PETITE B04

B04-9180-00-xx

ROUGH & TRIM PACKAGE

CC	KK	LL	BB	NN/YY	VV/TT	KM	GG
841	951	1025	1025	951	1061	1061	1281

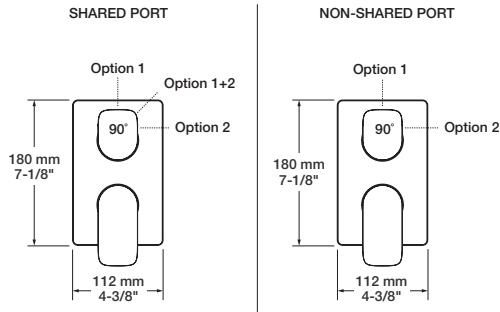

Complete pressure balanced shower control valve with 2-way diverter (shared port)

- A- 1 outlet: 5 gpm - 60 psi, 2 outlets: 2.6 gpm - 60 psi
- B- Volume control valve
- C- Up to 2 accessories can be used at the same time
- D- Thin brass plate
- E- CAR-1020-40 (volume), CAR-1001-35 (diverter)
- F- Rough valve RVA-9181-00-B included

Ecological options CEC

Codes	Features
B04-9180-00-xx-NS	Non-shared port
T04-9180-00-xx + RVA-9181-00-NS-B	1 accessory works at a time
T04-9180-00-xx + RVA-9181-PO-NS-B	CAR-1001-35-NS (diverter)

TRIM ONLY

T04-9180-00-xx

CC	KK	LL	BB	NN/YY	VV/TT	KM	GG
367	477	551	551	477	587	587	807

ROUGH VALVES Please order **one** of the following rough valves to complete the trim:

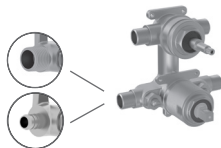

RVA-9181-00-B	2-way type P rough - 1/2" male NPT or welded copper connections	474
RVA-9181-PO-B	2-way type P rough - PEX connections	474

B04-9190-00-xx

ROUGH & TRIM PACKAGE

CC	KK	LL	BB	NN/YY	VV/TT	GG
896	1006	1080	1080	1006	1116	1336

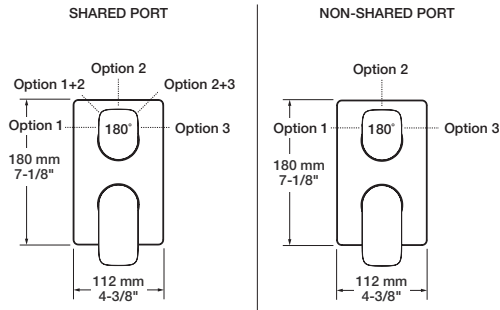

Complete pressure balanced shower control valve with 3-way diverter (shared port)

- A- 1 outlet: 5 gpm - 60 psi, 2 outlets: 2.6 gpm - 60 psi
- B- Volume control valve
- C- Up to 2 accessories can be used at the same time
- D- Thin brass plate
- E- CAR-1020-40 (volume), CAR-9220-02 (diverter)
- F- Rough valve RVA-9191-00-B included

Ecological options CEC

Codes	Features
B04-9190-00-xx-NS	Non-shared port
T04-9190-00-xx + RVA-9191-00-NS-B	1 accessory works at a time
T04-9190-00-xx + RVA-9191-PO-NS-B	CAR-9220-02-NS (diverter)

TRIM ONLY

T04-9190-00-xx

CC	KK	LL	BB	NN/YY	VV/TT	GG
367	477	551	551	477	587	807

ROUGH VALVES Please order **one** of the following rough valves to complete the trim:

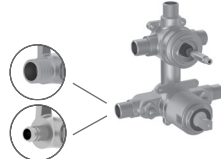

RVA-9191-00-B	3-way type P rough - 1/2" male NPT or welded copper connections	529
RVA-9191-PO-B	3-way type P rough - PEX connections	529

Finishes:

CC = chrome, KK = matte black, LL = satin brass, BB = white, NN = brushed nickel, YY = polished nickel, TT = venetian bronze, VV = satin copper, KM = black titanium, GG = gold

PETITE B04

B04-9404-00-xx

ROUGH & TRIM PACKAGE

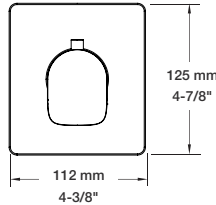

CC	KK	LL	BB	NN/YY	VV/TT	GG
1199	1354	1458	1458	1354	1509	1819

Complete 3/4" thermostatic valve

- A- 16 gpm - 60 psi
- B- Separate volume control or diverter valve required
- C- Can easily supply 3 accessories
- D- Thin brass plate
- E- CAR-3404-00
- F- Rough valve RVA-3404-00-B included
- G- Reversible check / non-return valves in case of water supply inversion

TRIM ONLY

T04-9404-00-xx

CC	KK	LL	BB	NN/YY	VV/TT	GG
517	672	776	776	672	827	1137

ROUGH VALVE Please order the following rough valve to complete the trim:

RVA-3404-00-B

Type T rough - 3/4" female NPT connections

682



B04-9453-00-xx

ROUGH & TRIM PACKAGE

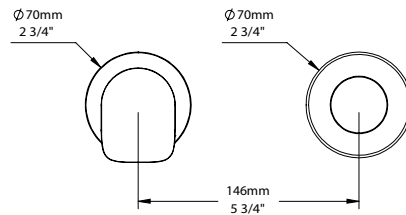

CC	KK	LL	BB	NN/YY	VV/TT	GG
1166	1321	1425	1425	1321	1476	1786

Complete 3/4" thermostatic valve

- A- 9 gpm - 60 psi
- B- Separate volume control or diverter valve required
- C- Can easily supply 3 accessories
- D- Hook on the side of the valve can be removed to give access to the check valves
- E- Reversible check / non-return valves in case of water supply inversion
- F- CAR-2661-00
- G- Rough valve RVA-3453-00-B included
- H- Large depth adjustment range

TRIM ONLY

T04-9453-00-xx

CC	KK	LL	BB	NN/YY	VV/TT	GG
517	672	776	776	672	827	1137

ROUGH VALVE Please order the following rough valve to complete the trim:

RVA-3453-00-B

Type T rough - 3/4" female NPT connections

649



THE ESSENTIALS

B04-9521-00-xx

ROUGH & TRIM PACKAGE

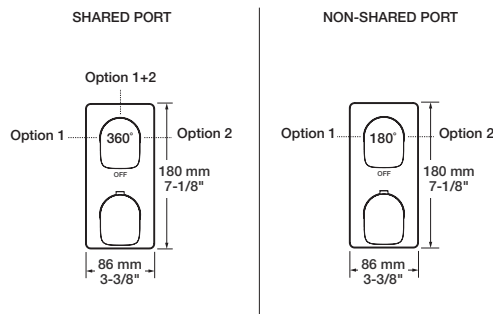

CC	KK	LL	BB	NN/YY	VV/TT	KM	GG
1118	1248	1335	1335	1248	1378	1378	1638

Complete thermostatic pressure balanced shower control valve with 2-way diverter (shared port)

- A- 1 outlet: 7.9 gpm - 60 psi, 2 outlets: 3.7 gpm - 60 psi
- B- Up to 2 accessories can be used at the same time
- C- Thin brass plate
- D- Reversible check / non-return valves in case of water supply inversion
- E- CAR-2661-00 (temperature), CAR-3003-36 (diverter)
- F- Rough valve RVA-9521-00-B included
- G- Large depth adjustment range

Ecological options CEC

Codes	Features
B04-9521-00-xx-NS	Non-shared port
T04-9521-00-xx + RVA-9521-00-NS-B	1 accessory works at a time
T04-9521-00-xx + RVA-9521-PO-NS-B	CAR-3003-36-NS (diverter)

TRIM ONLY

T04-9521-00-xx

CC	KK	LL	BB	NN/YY	VV/TT	KM	GG
433	563	650	650	563	693	693	953

ROUGH VALVES Please order **one** of the following rough valves to complete the trim:

RVA-9521-00-B

2-way TP rough - 1/2" male NPT or welded copper connections

685

RVA-9521-PO-B

2-way TP rough - PEX connections

685

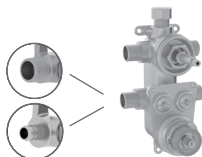

Actual products may differ from pictures. Actual products measures may differ from the measures shown. All USD prices are subject to change without notice. Effective as of August 2023.

PETITE B04

THE ESSENTIALS

B04-9531-00-xx

ROUGH & TRIM PACKAGE

CC	KK	LL	BB	NN/YY	VV/TT	KM	GG
1228	1358	1445	1445	1358	1488	1488	1748

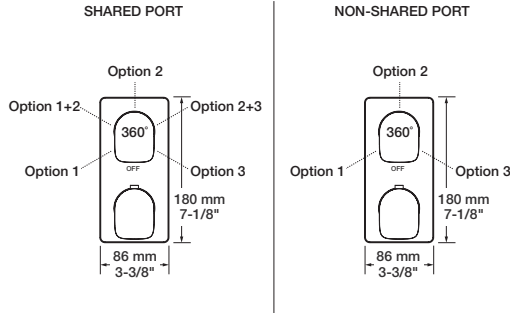

Complete thermostatic pressure balanced shower control valve with 3-way diverter (shared port)

- A- 1 outlet: 7.9 gpm - 60 psi, 2 outlets: 3.7 gpm - 60 psi
- B- Up to 2 accessories can be used at the same time
- C- Thin brass plate
- D- Reversible check / non-return valves in case of water supply inversion
- E- CAR-2661-00 (temperature), CAR-9531-03 (diverter)
- F- Rough valve RVA-9531-00-B included
- G- Large depth adjustment range

Ecological options CEC

Codes	Features
B04-9531-00-xx-NS	Non-shared port
T04-9531-00-xx + RVA-9531-00-NS-B	1 accessory works at a time
T04-9531-00-xx + RVA-9531-PO-NS-B	CAR-9531-03-NS (diverter)

TRIM ONLY

T04-9531-00-xx

CC	KK	LL	BB	NN/YY	VV/TT	KM	GG
433	563	650	650	563	693	693	953

ROUGH VALVES Please order **one** of the following rough valves to complete the trim:

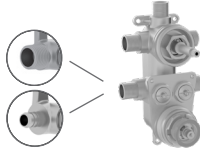

RVA-9531-00-B

3-way TP rough - 1/2" male NPT or welded copper connections

795

RVA-9531-PO-B

3-way TP rough - PEX connections

795

B04-9560-02-xx

ROUGH & TRIM PACKAGE

CC	KK	LL	BB	NN/YY	VV/TT	GG
513	577	620	620	577	641	770

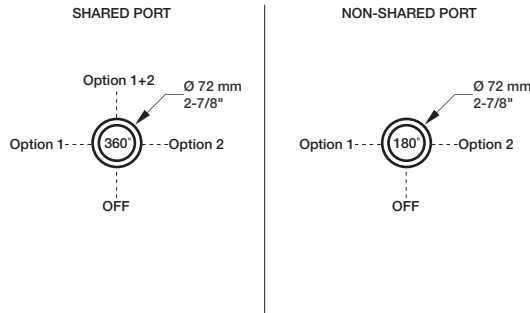

Complete 2-port diverter with stop (shared port)

- A- 1 outlet: 10.5 gpm - 60 psi, 2 outlets: 4 gpm - 60 psi
- B- Can replace 2 volume control valves
- C- Up to 2 accessories can be used at the same time
- D- CAR-9525-02
- E- Rough RVA-9562-00-B included
- F- Extra long cartridge for maximum adjustment

Ecological options CEC

Codes	Features
B04-9560-02-xx-NS	Non-shared port
T04-9560-02-xx + RVA-9562-00-NS-B	1 accessory works at a time
	CAR-9525-02-NS (diverter)

TRIM ONLY

T04-9560-02-xx

CC	KK	LL	BB	NN/YY	VV/TT	GG
214	278	321	321	278	342	471

ROUGH VALVE Please order the following rough valve to complete the trim:



RVA-9562-00-B

2-port diverter rough - 1/2" male NPT or welded copper connections

299

Finishes:

CC = chrome, KK = matte black, LL = satin brass, BB = white, NN = brushed nickel, YY = polished nickel, TT = venetian bronze, VV = satin copper, KM = black titanium, GG = gold

PETITE B04

B04-9560-03-xx

ROUGH & TRIM PACKAGE

CC	KK	LL	BB	NN/YY	VV/TT	GG
595	659	702	702	659	723	852

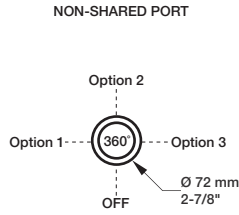
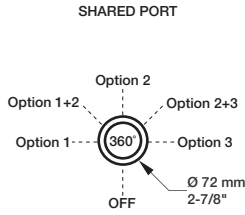

Complete 3-port diverter with stop (shared port)

- A- 1 outlet: 9.7 gpm - 60 psi, 2 outlets: 5.2 gpm - 60 psi
- B- Can replace 2 or 3 volume control valves
- C- Up to 2 accessories can be used at the same time
- D- CAR-9530-03
- E- Rough RVA-9563-00-B included
- F- Extra long cartridge for maximum adjustment

Ecological options CEC

Codes	Features
B04-9560-03-xx-NS	Non-shared port
T04-9560-03-xx + RVA-9563-00-NS-B	1 accessory works at a time
	CAR-9530-03-NS (diverter)

TRIM ONLY

T04-9560-03-xx

CC	KK	LL	BB	NN/YY	VV/TT	GG
214	278	321	321	278	342	471



ROUGH VALVE Please order the following rough valve to complete the trim:

RVA-9563-00-B

3-port diverter rough - inlet: 3/4" F NPT - outlets: 1/2" F NPT

381

B04-9649-00-xx

ROUGH & TRIM PACKAGE

CC	KK	LL	BB	NN/YY	VV/TT	GG
449	513	556	556	513	577	706

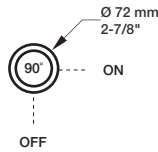

Complete 3/4" volume control valve

- A- 11.1 gpm - 60 psi
- B- Volume control valve
- C- Offers higher flow
- D- CAR-2719-34
- E- Rough valve RVA-2719-34-B included
- F- Extra long cartridge for maximum adjustment

TRIM ONLY

T04-9649-00-xx

CC	KK	LL	BB	NN/YY	VV/TT	GG
214	278	321	321	278	342	471



ROUGH VALVE Please order the following rough valve to complete the trim:

RVA-2719-34-B

Volume control valve rough - 3/4" female NPT connections

235

Actual products may differ from pictures. Actual products measures may differ from the measures shown. All USD prices are subject to change without notice. Effective as of August 2023.

PETITE B04

SELECTION OF SHOWER COMPONENTS

For more shower components and for ecological options, please refer to the shower components section (see p. 347-382).

TET-0815-01-xx 8" rounded square shower head  <table border="1"> <thead> <tr> <th>CC</th> <th>KK</th> <th>LL</th> <th>BB</th> </tr> </thead> <tbody> <tr> <td>460</td> <td>598</td> <td>690</td> <td>690</td> </tr> </tbody> </table>	CC	KK	LL	BB	460	598	690	690	TET-1014-01-xx 10" square shower head  <table border="1"> <thead> <tr> <th>CC</th> </tr> </thead> <tbody> <tr> <td>439</td> </tr> </tbody> </table>	CC	439	TET-1214-01-xx 12" square shower head  <table border="1"> <thead> <tr> <th>CC</th> </tr> </thead> <tbody> <tr> <td>595</td> </tr> </tbody> </table>	CC	595	TET-1208-01-xx 12" x 8" rectangular shower head  <table border="1"> <thead> <tr> <th>CC</th> <th>KK</th> </tr> </thead> <tbody> <tr> <td>462</td> <td>601</td> </tr> </tbody> </table>	CC	KK	462	601	BRA-1409-02-xx 15" L-shaped shower arm  <table border="1"> <thead> <tr> <th>CC</th> <th>KK</th> <th>LL</th> <th>BB</th> </tr> </thead> <tbody> <tr> <td>314</td> <td>408</td> <td>471</td> <td>471</td> </tr> </tbody> </table>	CC	KK	LL	BB	314	408	471	471																
CC	KK	LL	BB																																									
460	598	690	690																																									
CC																																												
439																																												
CC																																												
595																																												
CC	KK																																											
462	601																																											
CC	KK	LL	BB																																									
314	408	471	471																																									
TET-0814-01-xx 8" square shower head  <table border="1"> <thead> <tr> <th>CC</th> </tr> </thead> <tbody> <tr> <td>330</td> </tr> </tbody> </table>	CC	330	TET-1614-01-xx 16" square shower head  <table border="1"> <thead> <tr> <th>CC</th> </tr> </thead> <tbody> <tr> <td>832</td> </tr> </tbody> </table>	CC	832	TET-1614-91-xx 16" square built-in shower head  <table border="1"> <thead> <tr> <th>CC</th> </tr> </thead> <tbody> <tr> <td>1006</td> </tr> </tbody> </table>	CC	1006	TET-2012-01-xx 20" x 12" rectangular shower head  <table border="1"> <thead> <tr> <th>CC</th> </tr> </thead> <tbody> <tr> <td>965</td> </tr> </tbody> </table>	CC	965	BRA-1612-66-xx 16" shower arm  <table border="1"> <thead> <tr> <th>CC</th> <th>KK</th> <th>LL</th> <th>BB</th> </tr> </thead> <tbody> <tr> <td>179</td> <td>233</td> <td>269</td> <td>269</td> </tr> </tbody> </table>	CC	KK	LL	BB	179	233	269	269																								
CC																																												
330																																												
CC																																												
832																																												
CC																																												
1006																																												
CC																																												
965																																												
CC	KK	LL	BB																																									
179	233	269	269																																									
				BRA-1815-02-xx 18" shower arm  <table border="1"> <thead> <tr> <th>CC</th> <th>KK</th> <th>LL</th> <th>BB</th> </tr> </thead> <tbody> <tr> <td>325</td> <td>423</td> <td>488</td> <td>488</td> </tr> </tbody> </table>	CC	KK	LL	BB	325	423	488	488																																
CC	KK	LL	BB																																									
325	423	488	488																																									
DGL-2584-53-xx 3-spray sliding shower bar  <table border="1"> <thead> <tr> <th>CC</th> <th>KK</th> <th>LL</th> <th>BB</th> </tr> </thead> <tbody> <tr> <td>604</td> <td>785</td> <td>906</td> <td>906</td> </tr> </tbody> </table>	CC	KK	LL	BB	604	785	906	906	DGL-3080-83-xx 3-spray sliding shower bar  <table border="1"> <thead> <tr> <th>CC</th> <th>KK</th> <th>LL</th> <th>BB</th> </tr> </thead> <tbody> <tr> <td>759</td> <td>987</td> <td>1139</td> <td>1139</td> </tr> </tbody> </table>	CC	KK	LL	BB	759	987	1139	1139	DGL-4880-03-xx 3-spray sliding shower bar  <table border="1"> <thead> <tr> <th>CC</th> <th>KK</th> <th>LL</th> <th>BB</th> </tr> </thead> <tbody> <tr> <td>849</td> <td>1104</td> <td>1274</td> <td>1274</td> </tr> </tbody> </table>	CC	KK	LL	BB	849	1104	1274	1274	DSP-2604-19-xx Hand shower on wall-mounted supply elbow  <table border="1"> <thead> <tr> <th>CC</th> <th>KK</th> <th>LL</th> <th>BB</th> </tr> </thead> <tbody> <tr> <td>492</td> <td>639</td> <td>738</td> <td>738</td> </tr> </tbody> </table>	CC	KK	LL	BB	492	639	738	738	RAC-0618-02-xx 6" ceiling mount shower arm  <table border="1"> <thead> <tr> <th>CC</th> <th>KK</th> <th>LL</th> <th>BB</th> </tr> </thead> <tbody> <tr> <td>68</td> <td>88</td> <td>102</td> <td>102</td> </tr> </tbody> </table>	CC	KK	LL	BB	68	88	102	102
CC	KK	LL	BB																																									
604	785	906	906																																									
CC	KK	LL	BB																																									
759	987	1139	1139																																									
CC	KK	LL	BB																																									
849	1104	1274	1274																																									
CC	KK	LL	BB																																									
492	639	738	738																																									
CC	KK	LL	BB																																									
68	88	102	102																																									
				RAC-9001-16-xx 1/2" F wall-mount supply elbow  <table border="1"> <thead> <tr> <th>CC</th> <th>KK</th> <th>LL</th> <th>BB</th> </tr> </thead> <tbody> <tr> <td>124</td> <td>161</td> <td>186</td> <td>186</td> </tr> </tbody> </table>	CC	KK	LL	BB	124	161	186	186																																
CC	KK	LL	BB																																									
124	161	186	186																																									
BEC-0520-46-xx PROFILE tub spout without diverter  <table border="1"> <thead> <tr> <th>CC</th> <th>KK</th> <th>LL</th> <th>BB</th> </tr> </thead> <tbody> <tr> <td>434</td> <td>564</td> <td>651</td> <td>651</td> </tr> </tbody> </table>	CC	KK	LL	BB	434	564	651	651	BEC-0520-73-xx 7" round tub spout without diverter  <table border="1"> <thead> <tr> <th>CC</th> <th>KK</th> <th>LL</th> <th>BB</th> </tr> </thead> <tbody> <tr> <td>168</td> <td>218</td> <td>252</td> <td>252</td> </tr> </tbody> </table>	CC	KK	LL	BB	168	218	252	252	BEC-0520-74-xx 7" round tub spout with diverter  <table border="1"> <thead> <tr> <th>CC</th> <th>KK</th> <th>LL</th> <th>BB</th> </tr> </thead> <tbody> <tr> <td>198</td> <td>257</td> <td>297</td> <td>297</td> </tr> </tbody> </table>	CC	KK	LL	BB	198	257	297	297	BEC-0520-83-xx 7" square tub spout without diverter  <table border="1"> <thead> <tr> <th>CC</th> <th>KK</th> <th>LL</th> <th>BB</th> </tr> </thead> <tbody> <tr> <td>198</td> <td>257</td> <td>297</td> <td>297</td> </tr> </tbody> </table>	CC	KK	LL	BB	198	257	297	297	BEC-0520-84-xx 7" square tub spout with diverter  <table border="1"> <thead> <tr> <th>CC</th> <th>KK</th> <th>LL</th> <th>BB</th> </tr> </thead> <tbody> <tr> <td>228</td> <td>296</td> <td>342</td> <td>342</td> </tr> </tbody> </table>	CC	KK	LL	BB	228	296	342	342
CC	KK	LL	BB																																									
434	564	651	651																																									
CC	KK	LL	BB																																									
168	218	252	252																																									
CC	KK	LL	BB																																									
198	257	297	297																																									
CC	KK	LL	BB																																									
198	257	297	297																																									
CC	KK	LL	BB																																									
228	296	342	342																																									

Actual products may differ from pictures. Actual products measures may differ from the measures shown. All USD prices are subject to change without notice. Effective as of August 2023.

COMPLETE SHOWER KITS

PETITE B04

PRO-1104-53-xx



Complete thermostatic shower kit on column

CC	KK	LL	BB	NN/YY	VV/TT	GG
1795	2334	2693	2693	2334	2872	3949

Features

- A- Max: 2 gpm - 80 psi (per accessory)
- B- 3-spray push-button hand shower
- C- 2 accessories can work together
- D- Temperature handle on the hot water inlet side, allowing the surface temperature to never exceed the shower water temperature
- E- Shower head arm adjustable up to 20" in height
- F- Easy to move metal slider with built-in hook
- G- Thermostatic cartridge: CAR-2661-00
- H- Diverter cartridge: CAR-3003-36

Ecological options <small>CEC</small>	Code	Features are the same, except:
	PRO-1104-53-xx-NS	A- Max: 1.75 gpm - 80 psi (per accessory) C- 1 accessory works at a time H- Diverter cartridge: CAR-3003-36-NS

PRO-2100-04-xx



Complete pressure balanced shower kit

CC	KK	LL	BB	NN/YY	VV/TT	GG
1198	1557	1797	1797	1557	1917	2636

Features

- A- Max: 2 gpm - 80 psi
- B- 3-spray hand shower

Includes

- B04-9100-00-xx** Complete pressure balanced valve
- DGL-2584-53-xx** 3-spray sliding shower bar
- RAC-9001-16-xx** Wall-mount supply elbow

Ecological option <small>CEC</small>	Codes	Features are the same, except:
	PRO-2100-04-xx-175	A- Max: 1.75 gpm - 80 psi (hand shower)
	TRO-2100-04-xx-175 + RVA-9020-00-B	

TRIM ONLY

TRO-2100-04-xx	CC	KK	LL	BB	NN/YY	VV/TT	GG
	888	1247	1487	1487	1247	1607	2326

ROUGH VALVES Please order **one** of the following rough valves to complete the trim:

RVA-9020-00-B	Type P rough - 1/2" male NPT or welded copper connections	310
RVA-9020-PO-B	Type P rough - PEX connections	310

PRO-2200-04-xx



Complete pressure balanced shower kit

CC	KK	LL	BB	NN/YY	VV/TT	GG
1375	1788	2063	2063	1788	2200	3025

Features

- A- 2 accessories kit
- B- 6 gpm - 60 psi (bath spout)
- C- Max: 2 gpm - 80 psi (hand shower)
- D- 3-spray hand shower
- E- 1 accessory works at a time

Includes

- B04-9100-00-xx** Complete pressure balanced valve
- BEC-0520-74-xx** 7" round tub spout with diverter
- DGL-2584-53-xx** 3-spray sliding shower bar
- RAC-9001-16-xx** Wall-mount supply elbow

Ecological option <small>CEC</small>	Codes	Features are the same, except:
	PRO-2200-04-xx-175	C- Max: 1.75 gpm - 80 psi (hand shower)
	TRO-2200-04-xx-175 + RVA-9020-00-B	

TRIM ONLY

TRO-2200-04-xx	CC	KK	LL	BB	NN/YY	VV/TT	GG
	1065	1478	1753	1753	1478	1890	2715

ROUGH VALVES Please order **one** of the following rough valves to complete the trim:

RVA-9020-00-B	Type P rough - 1/2" male NPT or welded copper connections	310
RVA-9020-PO-B	Type P rough - PEX connections	310

Finishes:

CC = chrome, KK = matte black, LL = satin brass, BB = white, NN = brushed nickel, YY = polished nickel, TT = venetian bronze, VV = satin copper, KM = black titanium, GG = gold

PETITE B04

THE ESSENTIALS

PRO-2805-04-xx PRR-2805-04-xx*

Complete pressure balanced shower kit

CC	KK	LL	BB	NN/YY	VV/TT	GG
1798	2337	2697	2697	2337	2877	3956



Features

- A- 2 accessories kit
- B- Max: 2 gpm - 80 psi (per accessory)
- C- 3-spray hand shower
- D- 2 accessories can work together

Includes

- B04-9180-00-xx** Complete pressure balanced valve with 2-way diverter
- TET-0815-01-xx** 8" rounded square shower head
- BRA-1612-66-xx** 16" shower arm
- DGL-2584-53-xx** 3-spray sliding shower bar
- RAC-9001-16-xx** Wall-mount supply elbow

Ecological options CEC

Codes	Features are the same, except:
PRO-2805-04-xx-NS	B- Max: 1.75 gpm - 80 psi (per accessory)
TRO-2805-04-xx-NS + RVA-9181-00-NS-B	D- 1 accessory works at a time

TRIM ONLY

TRO-2805-04-xx TRR-2805-04-xx*	CC	KK	LL	BB	NN/YY	VV/TT	GG
	1324	1863	2223	2223	1863	2403	3482

ROUGH VALVES Please order **one** of the following rough valves to complete the trim:

RVA-9181-00-B	2-way type P rough - 1/2" male NPT or welded copper connections	474
RVA-9181-PO-B	2-way type P rough - PEX connections	474

PRO-2815-04-xx PRR-2815-04-xx*

Complete pressure balanced shower kit

CC	KK
1883	2448



Features

- A- 2 accessories kit
- B- Max: 2 gpm - 80 psi (per accessory)
- C- 3-spray hand shower
- D- 2 accessories can work together

Includes

- B04-9180-00-xx** Complete pressure balanced valve with 2-way diverter
- TET-1208-01-xx** 12" x 8" rectangular shower head
- BRA-1612-66-xx** 16" shower arm
- DGL-2584-53-xx** 3-spray sliding shower bar
- RAC-9001-26-xx** Wall-mount supply elbow

Ecological options CEC

Codes	Features are the same, except:
PRO-2815-04-xx-NS	B- Max: 1.75 gpm - 80 psi (per accessory)
TRO-2815-04-xx-NS + RVA-9181-00-NS-B	D- 1 accessory works at a time

TRIM ONLY

TRO-2815-04-xx TRR-2815-04-xx*	CC	KK
	1409	1974

ROUGH VALVES Please order **one** of the following rough valves to complete the trim:

RVA-9181-00-B	2-way type P rough - 1/2" male NPT or welded copper connections	474
RVA-9181-PO-B	2-way type P rough - PEX connections	474

PRO-2896-04-xx PRR-2896-04-xx*

Complete pressure balanced shower kit

CC	KK	LL	BB	NN/YY	VV/TT	GG
1595	2074	2393	2393	2074	2552	3509



Features

- A- 2 accessories kit
- B- Max: 2 gpm - 80 psi (per accessory)
- C- 1-spray hand shower
- D- 2 accessories can work together

Includes

- B04-9180-00-xx** Complete pressure balanced valve with 2-way diverter
- TET-0815-01-xx** 8" rounded square shower head
- BRA-1612-66-xx** 16" shower arm
- DSP-2604-19-xx** Hand shower on wall-mounted supply elbow

Ecological options CEC

Codes	Features are the same, except:
PRO-2896-04-xx-NS	B- Max: 1.75 gpm - 80 psi (per accessory)
TRO-2896-04-xx-NS + RVA-9181-00-NS-B	D- 1 accessory works at a time

TRIM ONLY

TRO-2896-04-xx TRR-2896-04-xx*	CC	KK	LL	BB	NN/YY	VV/TT	GG
	1121	1600	1919	1919	1600	2078	3035

ROUGH VALVES Please order **one** of the following rough valves to complete the trim:

RVA-9181-00-B	2-way type P rough - 1/2" male NPT or welded copper connections	474
RVA-9181-PO-B	2-way type P rough - PEX connections	474

Actual products may differ from pictures. Actual products measures may differ from the measures shown. All USD prices are subject to change without notice. Effective as of August 2023.

PRO-2915-04-xx PRR-2915-04-xx*



Complete pressure balanced shower kit

CC	KK
2057	2674

Features

- A- 3 accessories kit
- B- 5 gpm - 60 psi (bath spout)
- C- Max: 2 gpm - 80 psi (shower accessories)
- D- 3-spray hand shower
- E- 2 accessories can work together

Includes

- B04-9190-00-xx** Complete pressure balanced valve with 3-way diverter
- BEC-0520-73-xx** 7" round tub spout without diverter
- TET-1208-01-xx** 12" x 8" rectangular shower head
- BRA-1612-66-xx** 16" shower arm
- DGL-2584-53-xx** 3-spray sliding shower bar
- RAC-9001-26-xx** Wall-mount supply elbow

Ecological options	CEC	Codes	Features are the same, except:
		PRO-2915-04-xx-NS	C- Max: 2 gpm - 80 psi - 80 psi (shower accessories)
		TRO-2915-04-xx-NS + RVA-9191-00-NS-B	E- 1 accessory works at a time

TRIM ONLY

TRO-2915-04-xx TRR-2915-04-xx*	CC	KK
	1528	2145

ROUGH VALVES Please order **one** of the following rough valves to complete the trim:

RVA-9191-00-B	3-way type P rough - 1/2" male NPT or welded copper connections	529
RVA-9191-PO-B	3-way type P rough - PEX connections	529

PRO-3302-04-xx PRR-3302-04-xx*



Complete thermostatic shower kit

CC	KK	LL	BB	NN/YY	VV/TT	GG
2350	3055	3525	3525	3055	3760	5170

Features

- A- 2 accessories kit
- B- Max: 2 gpm - 80 psi (per accessory)
- C- 1-spray hand shower
- D- 2 accessories can work together
- E- Hook as part of the thermostatic valve trim

Includes

- B04-9453-00-xx** Complete 3/4" thermostatic valve
- B04-9560-02-xx** Complete 2-port diverter with off
- TET-0815-01-xx** 8" rounded square shower head
- BRA-1612-66-xx** 16" shower arm
- DSP-2604-21-xx** Hand shower on wall-mounted supply elbow

Ecological options	CEC	Codes	Features are the same, except:
		PRO-3302-04-xx-NS	B- Max: 1.75 gpm - 80 psi (per accessory)
		TRO-3302-04-xx-NS + RVA-3453-00-B + RVA-9562-00-NS-B	D- 1 accessory works at a time

TRIM ONLY

TRO-3302-04-xx TRR-3302-04-xx*	CC	KK	LL	BB	NN/YY	VV/TT	GG
	1402	2107	2577	2577	2107	2812	4222

ROUGH VALVES Please order **all** of the following rough valves to complete the trim:

RVA-3453-00-B	Type T rough - 3/4" female NPT connections	649
RVA-9562-00-B	2-port diverter rough - 1/2" male NPT or welded copper connections	299

PRO-3405-04-xx PRR-3405-04-xx*



Complete thermostatic shower kit

CC	KK	LL	BB	NN/YY	VV/TT	GG
2439	3171	3659	3659	3171	3902	5366

Features

- A- 2 accessories kit
- B- Max: 2 gpm - 80 psi (per accessory)
- C- 3-spray hand shower
- D- 2 accessories can work together

Includes

- B04-9404-00-xx** Complete 3/4" thermostatic valve
- B04-9560-02-xx** Complete 2-port diverter with stop
- TET-0815-01-xx** 8" rounded square shower head
- BRA-1612-66-xx** 16" shower arm
- DGL-2584-53-xx** 3-spray sliding shower bar
- RAC-9001-16-xx** Elbow connector

Ecological options	CEC	Codes	Features are the same, except:
		PRO-3405-04-xx-NS	B- Max: 1.75 gpm - 80 psi (per accessory)
		TRO-3405-04-xx-NS + RVA-3404-00-B + RVA-9562-00-NS-B	D- 1 accessory works at a time

TRIM ONLY

TRO-3405-04-xx TRR-3405-04-xx*	CC	KK	LL	BB	NN/YY	VV/TT	GG
	1458	2190	2678	2678	2190	2921	4385

ROUGH VALVES Please order **all** of the following rough valves to complete the trim:

RVA-3404-00-B	Type T rough - 3/4" female NPT connections	682
RVA-9562-00-B	2-port diverter rough - 1/2" male NPT or welded copper connections	299

Finishes:

CC = chrome, KK = matte black, LL = satin brass, BB = white, NN = brushed nickel, YY = polished nickel, TT = venetian bronze, VV = satin copper, KM = black titanium, GG = gold

* With 6" ceiling mount shower arm

PETITE B04

PRO-3950-04-xx PRR-3950-04-xx*



Complete thermostatic shower kit

CC	KK	LL	BB	NN/YY	VV/TT	GG
3795	4934	5693	5693	4934	6072	8349

Features

- A- 3 accessories kit
- B- Max: 2 gpm - 80 psi (per accessory)
- C- 8.0 gpm for 4 body jets
- C- 3-spray hand shower
- D- 3 accessories can work together

Includes

- B04-9404-00-xx** Complete 3/4" thermostatic valve
- B04-9649-00-xx** Complete 3/4" shut-off valve (3)
- TET-0815-01-xx** 8" rounded square shower head
- BRA-1812-02-xx** 18" shower arm
- DGL-2584-53-xx** 3-spray sliding shower bar
- RAC-9001-16-xx** Elbow connector
- BOD-5004-02-xx** Built-in body jet (3)

TRIM ONLY

TRO-3950-04-xx TRR-3950-04-xx*	CC	KK	LL	BB	NN/YY	VV/TT	GG
	2408	3547	4306	4306	3547	4685	6962

ROUGH VALVES Please order **all** of the following rough valves to complete the trim:

1x RVA-3404-00-B	Type T rough - 3/4" female NPT connections	682
3x RVA-2719-34-B	Volume control valve rough - 3/4" female NPT connections	235

THE ESSENTIALS

PRO-4205-04-xx PRR-4205-04-xx*



Complete thermostatic pressure balanced shower kit

CC	KK	LL	BB	NN/YY	VV/TT	KM	GG
2010	2613	3015	3015	2613	3216	3216	4422

Features

- A- 2 accessories kit
- B- Max: 2 gpm - 80 psi (per accessory)
- C- 3-spray hand shower
- D- 2 accessories can work together

Includes

- B04-9521-00-xx** Complete type TP shower valve with 2-way diverter
- TET-0815-01-xx** 8" rounded square shower head
- BRA-1612-66-xx** 16" shower arm
- DGL-2584-53-xx** 3-spray sliding shower bar
- RAC-9001-16-xx** Wall-mount supply elbow

Ecological options CEC

Codes

PRO-4205-04-xx-NS
TRO-4205-04-xx-NS + RVA-9521-00-NS-B

Features are the same, **except:**

B- Max: 1.75 gpm - 80 psi (per accessory)
D- 1 accessory works at a time

TRIM ONLY

TRO-4205-04-xx TRR-4205-04-xx*	CC	KK	LL	BB	NN/YY	VV/TT	KM	GG
	1325	1928	2330	2330	1928	2531	2531	3737

ROUGH VALVES Please order **one** of the following rough valves to complete the trim:

RVA-9521-00-B	2-way TP rough - 1/2" male NPT or welded copper connections	685
RVA-9521-P0-B	2-way TP rough - PEX connections	685

PRO-4215-04-xx PRR-4215-04-xx*



Complete thermostatic pressure balanced shower kit

CC	KK
2125	2763

Features

- A- 2 accessories kit
- B- Max: 2 gpm - 80 psi (per accessory)
- C- 3-spray hand shower
- D- 2 accessories can work together

Includes

- B04-9521-00-xx** Complete type TP shower valve with 2-way diverter
- TET-1208-01-xx** 12" x 8" rectangular shower head
- BRA-1612-66-xx** 16" shower arm
- DGL-2584-53-xx** 3-spray sliding shower bar
- RAC-9001-26-xx** Wall-mount supply elbow

Ecological options CEC

Codes

PRO-4215-04-xx-NS
TRO-4215-04-xx-NS + RVA-9521-00-NS-B

Features are the same, **except:**

B- Max: 1.75 gpm - 80 psi (per accessory)
D- 1 accessory works at a time

TRIM ONLY

TRO-4215-04-xx TRR-4215-04-xx*	CC	KK
	1440	2078

ROUGH VALVES Please order **one** of the following rough valves to complete the trim:

RVA-9521-00-B	2-way TP rough - 1/2" male NPT or welded copper connections	685
RVA-9521-P0-B	2-way TP rough - PEX connections	685

PETITE B04

PETITE B04

PRO-4296-04-xx PRR-4296-04-xx*



Complete thermostatic pressure balanced shower kit

CC	KK	LL	BB	NN/YY	VV/TT	GG
1757	2284	2636	2636	2284	2811	3865

Features

- A- 2 accessories kit
- B- Max: 2 gpm - 80 psi (per accessory)
- C- 3-spray hand shower
- D- 2 accessories can work together

Includes

- B04-9521-00-xx** Complete type TP shower valve with 2-way diverter
- TET-0815-01-xx** 8" rounded square shower head
- BRA-1612-66-xx** 16" shower arm
- DSP-2584-19-xx** Hand shower on wall-mounted supply elbow

Ecological options CEC

Codes	Features are the same, except:
PRO-4296-04-xx-NS	B- Max: 1.75 gpm - 80 psi (per accessory)
TRO-4296-04-xx-NS + RVA-9521-00-NS-B	D- 1 accessory works at a time

TRIM ONLY

TRO-4296-04-xx TRR-4296-04-xx*

CC	KK	LL	BB	NN/YY	VV/TT	GG
1072	1599	1951	1951	1599	2126	3180

ROUGH VALVES Please order **one** of the following rough valves to complete the trim:

RVA-9521-00-B	2-way TP rough - 1/2" male NPT or welded copper connections	685
RVA-9521-PO-B	2-way TP rough - PEX connections	685

THE ESSENTIALS

PRO-4305-04-xx PRR-4305-04-xx*



Complete thermostatic pressure balanced shower kit

CC	KK	LL	BB	NN/YY	VV/TT	KM	GG
2494	3242	3741	3741	3242	3990	3990	5487

Features

- A- 3 accessories kit
- B- 7.9 gpm - 60 psi (bath spout)
- C- Max: 2 gpm - 80 psi (shower accessories)
- D- 3-spray hand shower
- E- 2 accessories can work together

Includes

- B04-9531-00-xx** Complete TP shower control valve with 3-way diverter
- BEC-0520-46-xx** Profile tub spout without diverter
- TET-0815-01-xx** 8" rounded square shower head
- BRA-1612-66-xx** 16" shower arm
- DGL-2584-53-xx** 3-spray sliding shower bar
- RAC-9001-16-xx** Wall-mount supply elbow

Ecological options CEC

Codes	Features are the same, except:
PRO-4305-04-xx-NS	C- Max: 1.75 gpm - 80 psi (shower accessories)
TRO-4305-04-xx-NS + RVA-9531-00-NS-B	E- 1 accessory works at a time

TRIM ONLY

TRO-4305-04-xx TRR-4305-04-xx*

CC	KK	LL	BB	NN/YY	VV/TT	KM	GG
1699	2447	2946	2946	2447	3195	3195	4692

ROUGH VALVES Please order **one** of the following rough valves to complete the trim:

RVA-9531-00-B	3-way TP rough - 1/2" male NPT or welded copper connections	795
RVA-9531-PO-B	3-way TP rough - PEX connections	795

Finishes:

CC = chrome, KK = matte black, LL = satin brass, BB = white, NN = brushed nickel, YY = polished nickel, TT = venetian bronze, VV = satin copper, KM = black titanium, GG = gold

* With 6" ceiling mount shower arm

PETITE B04

PRO-4316-04-xx
PRR-4316-04-xx*

**Complete thermostatic
pressure balanced shower kit**

CC	KK
2645	3439



Features

- A- 3 accessories kit
- B- 7.9 gpm - 60 psi (bath spout)
- C- Max: 2 gpm - 80 psi (shower accessories)
- D- 3-spray hand shower
- E- 2 accessories can work together

Includes

- B04-9531-00-xx** Complete type TP shower control valve with 3-way diverter
- BEC-0520-46-xx** Profile tub spout without diverter
- TET-1208-01-xx** 12" x 8" rectangular shower head
- BRA-1612-66-xx** 16" shower arm
- DGL-2584-53-xx** 3-spray sliding shower bar
- RAC-9001-26-xx** Wall-mount supply elbow

Ecological options **CEC**

Codes

PRO-4316-04-xx-NS
TRO-4316-04-xx-NS + RVA-9531-00-NS-B

Features are the same, except:

C- Max: 1.75 gpm - 80 psi (shower accessories)
E- 1 accessory works at a time

TRIM ONLY

TRO-4316-04-xx
TRR-4316-04-xx*

CC	KK
1850	2644

ROUGH VALVES Please order **one** of the following rough valves to complete the trim:

RVA-9531-00-B

3-way TP rough - 1/2" male NPT or welded copper connections

795

RVA-9531-PO-B

3-way TP rough - PEX connections

795

Actual products may differ from pictures. Actual products measures may differ from the measures shown. All USD prices are subject to change without notice. Effective as of August 2023.

SELECTION OF BATHROOM ACCESSORIES

For more bathroom accessories, please refer to the bathroom accessories section (see p. 293-306).

A04-1029-00-xx
PETITE
 Wall-mounted toilet paper holder



CC	KK	LL	BB	NN/YY	VV/TT	KM
197	256	296	296	256	315	394

A04-1069-00-xx
PETITE
 Bathrobe holder



CC	KK	LL	BB	NN/YY	VV/TT	KM
92	120	138	138	120	147	184

A04-6012-00-xx
PETITE
 12" single towel bar

Available Q3 2023



CC	KK	LL	BB	NN/YY	VV/TT	KM
245	319	368	368	319	392	490

A04-6018-00-xx
PETITE
 18" single towel bar



CC	KK	LL	BB	NN/YY	VV/TT	KM
275	358	413	413	358	440	550

A04-6024-00-xx
PETITE
 24" single towel bar



CC	KK	LL	BB	NN/YY	VV/TT	KM
305	397	458	458	397	488	610

A04-6030-00-xx
PETITE
 30" single towel bar



CC	KK	LL	BB	NN/YY	VV/TT	KM
385	501	578	578	501	616	770

A85-3179-00-xx
 Shower squeegee



CC
173

A85-9077-00-xx
 Corner basket



CC
248

Finishes:

CC = chrome, KK = matte black, LL = satin brass, BB = white, NN = brushed nickel, YY = polished nickel, TT = venetian bronze, VV = satin copper, KM = black titanium, GG = gold

REC B05

Compatible with the Touchless Sensor
Order ELE-2001-01-xx (p. 43)



BARIL

REC B05

B05-1005-1PL-xx

DRAIN INCLUDED

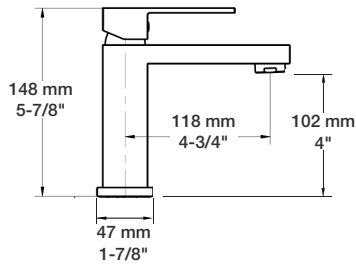

CC	KK	LL	BB	NN/YY	VV/TT	GG
635	825	952	952	825	1015	1396

Single-hole lavatory faucet, drain included

- A- 1.5 gpm - 60 psi
- B- Adjustable aerator
- C- CAR-1025-09
- D- Push-button drain with overflow included

Ecological options

Codes	Reduced flow rates
B05-1005-XXL-xx-120	1.2 gpm (4.5 l/min) - 60 psi
B05-1005-XXL-xx-100	1.0 gpm (3.7 l/min) - 60 psi
B05-1005-XXL-xx-050	0.5 gpm (1.9 l/min) - 60 psi

CEC

DRAIN NOT INCLUDED

B05-1005-00L-xx

D- Order your lavatory drain (pages 309-310)

CC	KK	LL	BB	NN/YY	VV/TT	GG
587	762	880	880	762	938	1285

B05-1010-1PL-xx

DRAIN INCLUDED

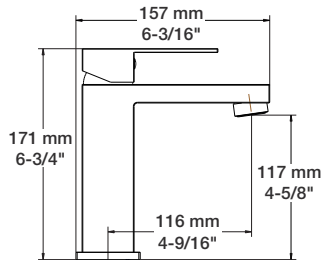

CC	KK	LL	BB	NN/YY	VV/TT	GG
675	878	1013	1013	878	1080	1485

Single-hole lavatory faucet, drain included

- A- 1.5 gpm - 60 psi
- B- Adjustable aerator
- C- CAR-1031-49
- D- Push-button drain with overflow included

Ecological options

Codes	Reduced flow rates
B05-1010-XXL-xx-120	1.2 gpm (4.5 l/min) - 60 psi
B05-1010-XXL-xx-100	1.0 gpm (3.7 l/min) - 60 psi
B05-1010-XXL-xx-050	0.5 gpm (1.9 l/min) - 60 psi

CEC

DRAIN NOT INCLUDED

B05-1010-01L-xx

D- Order your lavatory drain (pages 309-310)

CC	KK	LL	BB	NN/YY	VV/TT	GG
627	815	941	941	815	1003	1374

B05-1015-1PL-xx

DRAIN INCLUDED

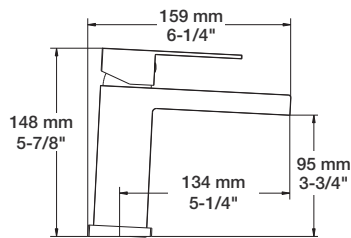

CC
734

Single-hole lavatory faucet, drain included

- A- 1.5 gpm - 60 psi
- B- CAR-1025-09
- C- Push-button drain with overflow included
- D- Previously: B95-1010-1PL-CC

Ecological options

Codes	Reduced flow rates
B05-1015-XXL-xx-120	1.2 gpm (4.5 l/min) - 60 psi
B05-1015-XXL-xx-100	1.0 gpm (3.7 l/min) - 60 psi
B05-1015-XXL-xx-050	0.5 gpm (1.9 l/min) - 60 psi

CEC

DRAIN NOT INCLUDED

B05-1015-01L-xx

C- Order your lavatory drain (pages 309-310)

CC
686

B05-1020-00L-xx

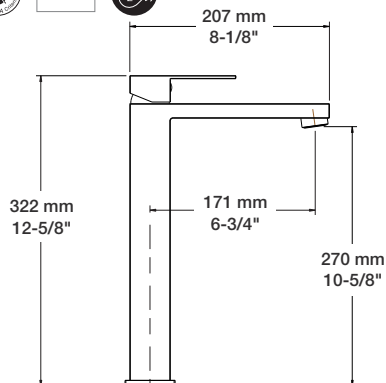

CC	KK	LL	BB	NN/YY	VV/TT	GG
826	1074	1239	1239	1074	1322	1817

High single-hole lavatory faucet, drain not included

- A- 1.5 gpm - 60 psi
- B- Order your lavatory drain (pages 309- 310)
- C- Adjustable aerator
- D- CAR-1031-49

Ecological options

Codes	Reduced flow rates
B05-1020-00L-xx-120	1.2 gpm (4.5 l/min) - 60 psi
B05-1020-00L-xx-100	1.0 gpm (3.7 l/min) - 60 psi
B05-1020-00L-xx-050	0.5 gpm (1.9 l/min) - 60 psi

CEC

Actual products may differ from pictures. Actual products measures may differ from the measures shown. All USD prices are subject to change without notice. Effective as of August 2023.

B05-8009-00L-xx

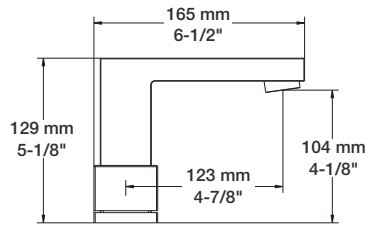
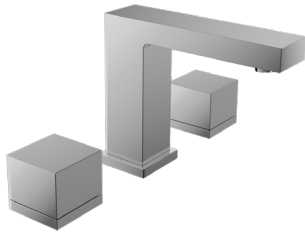

CC	KK	LL	BB	NN/YY	VV/TT	GG
1057	1374	1586	1586	1374	1691	2326

8" c/c lavatory faucet, drain included

- A- 1.5 gpm - 60 psi
- B- Push-button drain with overflow included
- C- Adjustable aerator
- D- CAR-1020-01 (Cold), CAR-1020-02 (Hot)

Ecological options

Codes	Reduced flow rates	CEC
B05-8009-00L-xx-120	1.2 gpm (4.5 l/min) - 60 psi	
B05-8009-00L-xx-100	1.0 gpm (3.7 l/min) - 60 psi	
B05-8009-00L-xx-050	0.5 gpm (1.9 l/min) - 60 psi	

B05-8100-00L-xx

COMPLETE FAUCET

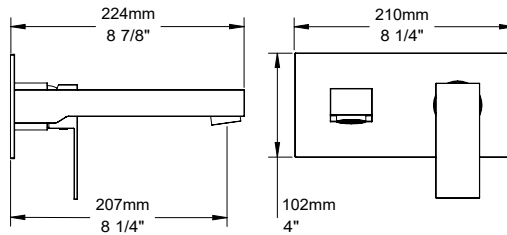
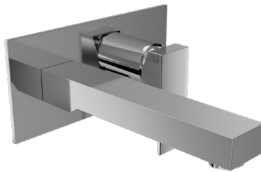

CC	KK	LL	BB	NN/YY	VV/TT	GG
913	1187	1369	1369	1187	1460	2008

Single lever wall-mounted lavatory faucet, drain not included

- A- 1.5 gpm - 60 psi
- B- Order your lavatory drain (pages 309- 310)
- C- Adjustable aerator
- D- One-piece rough with wall plate for easy installation
- E- CAR-1031-49

Ecological options

Codes	Reduced flow rates	CEC
B05-8100-00L-xx-120	1.2 gpm (4.5 l/min) - 60 psi	
B05-8100-00L-xx-100	1.0 gpm (3.7 l/min) - 60 psi	
B05-8100-00L-xx-050	0.5 gpm (1.9 l/min) - 60 psi	



TRIM ONLY

T05-8100-00L-xx

CC	KK	LL	BB	NN/YY	VV/TT	GG
571	845	1027	1027	845	1118	1666

ROUGH Please order the following rough to complete the trim:

ROU-8100-03-B

Single lever wall-mounted lavatory rough - 1/2" male NPT or welded copper connections

342

B05-1100-02-xx

COMPLETE FAUCET

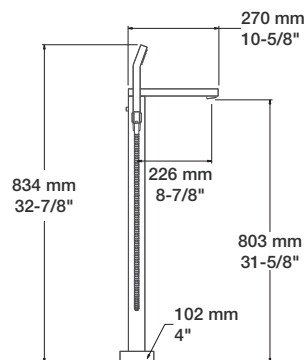

CC	KK	LL	BB	NN/YY	VV/TT	GG
2395	3114	3593	3593	3114	3832	5269

Floor-mounted tub filler with hand shower

Bath spout:

- A- 5.5 gpm - 60 psi
- B- Tub spout with integrated push-button diverter

Hand shower:

- C- Max: 2 gpm - 80 psi
- D- Reclining hand shower holder
- E- Hand shower DOU-2555-01-xx with 59" hose
- F- CAR-1060-01
- G- PVC hose in KK finish or brass for other finishes

Ecological options

Codes	Reduced flow rates	CEC
B05-1100-02-xx-150	1.5 gpm (5.7 l/min) - 80 psi	
B05-1100-02-xx-175	1.75 gpm (6.6 l/min) - 80 psi	

TRIM ONLY

T05-1100-02-xx

CC	KK	LL	BB	NN/YY	VV/TT	GG
2260	2979	3458	3458	2979	3697	5134

MOUNTING KIT Please order the following kit to complete the trim:

FIX-1100-00-B

Floor mounting kit for floor-mounted tub filler with hand shower

135



Finishes:

CC = chrome, KK = matte black, LL = satin brass, BB = white, NN = brushed nickel, YY = polished nickel, TT = venetian bronze, VV = satin copper, GG = gold 89

REC B05

B05-1269-00-xx

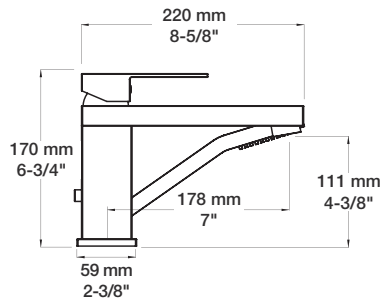

CC	KK	LL	BB	NN/YY	VV/TT	GG
1208	1570	1812	1812	1570	1933	2658

2-piece tub filler with hand shower

- A- Double-walled faucet limiting heat conduction
- Bath spout:**
- B- 7.9 gpm - 60 psi
- C- Tub spout with integrated push-button diverter
- Hand shower:**
- D- Max: 2 gpm - 80 psi
- E- Non-conductive brass anti-limestone hand shower
- F- DOU-1455-02-xx
- G- CAR-1031-49

Ecological options

Codes	Reduced flow rates
B05-1269-00-xx-150	1.5 gpm (5.7 l/min) - 80 psi
B05-1269-00-xx-175	1.75 gpm (6.6 l/min) - 80 psi

CEC

B05-1331-07-xx

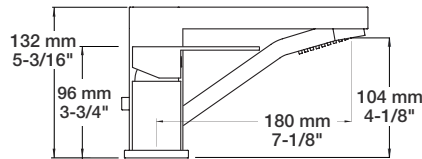

CC	KK	LL	BB	NN/YY	VV/TT	GG
1334	1735	2001	2001	1735	2135	2935

3-piece tub filler with hand shower

- Bath spout:**
- A- 5.8 gpm - 60 psi
- B- Tub spout with integrated push-button diverter
- Hand shower:**
- C- Max: 2 gpm - 80 psi
- D- Non-conductive brass anti-limestone hand shower
- E- DOU-1455-02-xx
- F- CAR-1031-49

Ecological options

Codes	Reduced flow rates
B05-1331-07-xx-150	1.5 gpm (5.7 l/min) - 80 psi
B05-1331-07-xx-175	1.75 gpm (6.6 l/min) - 80 psi

CEC

B05-1600-00-xx

COMPLETE FAUCET

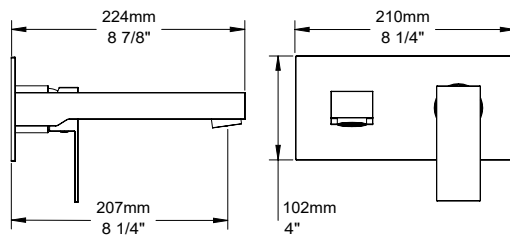
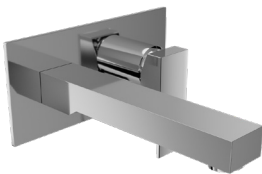

CC	KK	LL	BB	NN/YY	VV/TT	GG
1127	1465	1690	1690	1465	1803	2479

Wall-mounted tub faucet

- A- 5.3 gpm - 60 psi
- B- One-piece rough with wall plate for easy installation
- C- CAR-1031-49



TRIM ONLY

T05-1600-00-xx

CC	KK	LL	BB	NN/YY	VV/TT	GG
785	1123	1348	1348	1123	1461	2137

ROUGH Please order the following rough to complete the trim:

ROU-1600-03-B

Wall-mounted tub faucet rough - 1/2" male NPT or welded copper connections

342

Actual products may differ from pictures. Actual products measures may differ from the measures shown. All USD prices are subject to change without notice. Effective as of August 2023.

B05-2001-00-xx

COMPLETE FAUCET

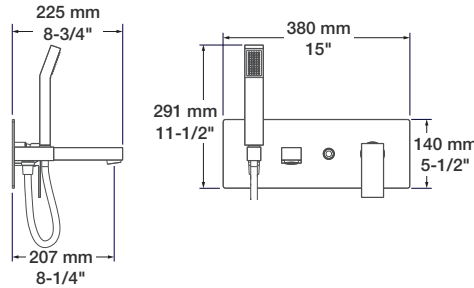
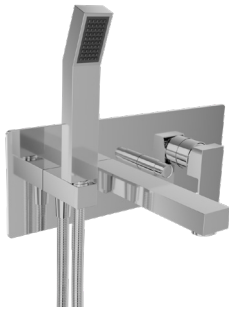

CC	KK	LL	BB	NN/YY	VV/TT	GG
2118	2753	3176	3176	2753	3388	4659

Wall-mounted tub faucet with hand shower

Bath spout:

A- 6.6 gpm - 60 psi

Hand shower:

B- Max: 2 gpm - 80 psi

C- Robust and easy-to-use push-button diverter

D- Push-button can be locked in the engaged position

E- Easy to install one-piece rough

F- DOU-2555-01-xx with 43" hose

G- CAR-1060-01

H- PVC hose in KK finish or brass for other finishes

Ecological options

Codes	Reduced flow rates
B05-2001-00-xx-150	1.5 gpm (5.7 l/min) - 80 psi
B05-2001-00-xx-175	1.75 gpm (6.6 l/min) - 80 psi CEC

TRIM ONLY

T05-2001-00-xx

Cartridge included with the trim

CC	KK	LL	BB	NN/YY	VV/TT	GG
1556	2191	2614	2614	2191	2826	4097

ROUGH Please order the following rough to complete the trim:

ROU-2000-99-B

Wall-mounted tub faucet rough (without cartridge)- 1/2" female NPT connections

562

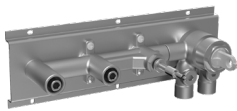

B05-9100-00-xx

ROUGH & TRIM PACKAGE

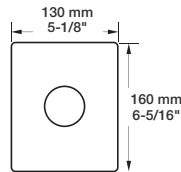

CC	KK	LL	BB	NN/YY	VV/TT	GG
660	765	835	835	765	870	1080

Complete pressure balanced shower control valve

A- 6 gpm - 60 psi

B- Volume control valve

C- CAR-1020-40

D- Rough valve RVA-9020-00-B included

TRIM ONLY

T05-9139-01-xx

CC	KK	LL	BB	NN/YY	VV/TT	GG
350	455	525	525	455	560	770

ROUGH VALVES Please order **one** of the following rough valves to complete the trim:

RVA-9020-00-B

Type P rough - 1/2" male NPT or welded copper connections

310

RVA-9020-PO-B

Type P rough - PEX connections

310

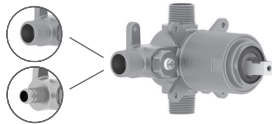

B05-9181-00-xx

ROUGH & TRIM PACKAGE

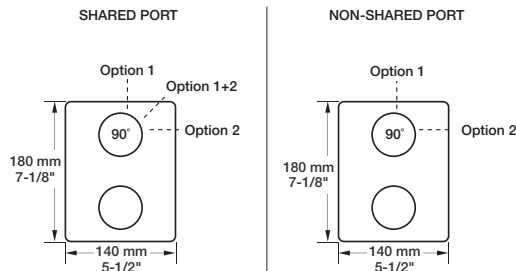

CC	KK	LL	BB	NN/YY	VV/TT	GG
917	1050	1139	1139	1050	1183	1449

Complete pressure balanced shower control valve with 2-way diverter (shared port)

A- 1 outlet: 5 gpm - 60 psi, 2 outlets: 2.6 gpm - 60 psi

B- Volume control valve

C- Up to 2 accessories can be used at the same time

D- CAR-1020-40 (volume), CAR-1001-35 (diverter)

E- Rough valve RVA-9181-00-B included

Ecological options CEC

Codes	Features
B05-9181-00-xx-NS	Non-shared port
T05-9181-00-xx + RVA-9181-00-NS-B	1 accessory works at a time
T05-9181-00-xx + RVA-9181-PO-NS-B	CAR-1001-35-NS (diverter)

TRIM ONLY

T05-9181-00-xx

CC	KK	LL	BB	NN/YY	VV/TT	GG
443	576	665	665	576	709	975

ROUGH VALVES Please order **one** of the following rough valves to complete the trim:

RVA-9181-00-B

2-way type P rough - 1/2" male NPT or welded copper connections

474

RVA-9181-PO-B

2-way type P rough - PEX connections

474

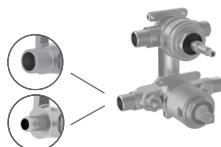

Finishes:

CC = chrome, KK = matte black, LL = satin brass, BB = white, NN = brushed nickel, YY = polished nickel, TT = venetian bronze, VV = satin copper, GG = gold

REC B05

B05-9404-00-xx

ROUGH & TRIM PACKAGE

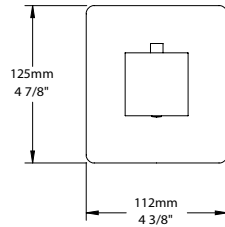

CC	KK	LL	BB	NN/YY	VV/TT	GG
1243	1411	1523	1523	1411	1579	1915

Complete 3/4" thermostatic valve

- A- 16 gpm - 60 psi
- B- Separate volume control or diverter valve required
- C- Can easily supply 3 accessories
- D- Thin brass plate
- E- CAR-3404-00
- F- Rough valve RVA-3404-00-B included
- G- Reversible check / non-return valves in case of water supply inversion

TRIM ONLY

T05-9404-00-xx

CC	KK	LL	BB	NN/YY	VV/TT	GG
561	729	841	841	729	897	1233

ROUGH VALVE Please order the following rough valve to complete the trim:

RVA-3404-00-B

Type T rough - 3/4" female NPT connections

682



B05-9521-00-xx

ROUGH & TRIM PACKAGE

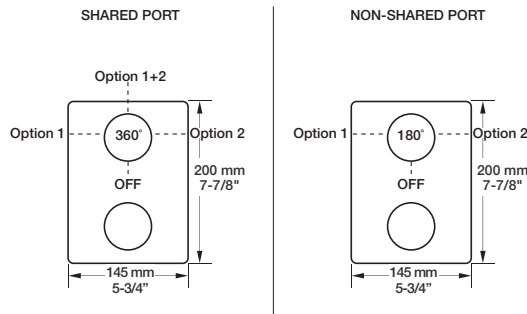

CC	KK	LL	BB	NN/YY	VV/TT	GG
1153	1293	1387	1387	1293	1434	1715

Complete thermostatic pressure balanced shower control valve with 2-way diverter (shared port)

- A- 1 outlet: 7.9 gpm - 60 psi, 2 outlets: 3.7 gpm - 60 psi
- B- Up to 2 accessories can be used at the same time
- C- Thin brass plate
- D- Reversible check / non-return valves in case of water supply inversion
- E- CAR-2661-00 (temperature), CAR-3003-36 (diverter)
- F- Rough valve RVA-9521-00-B included
- G- Large depth adjustment range

Ecological options CEC

Codes	Features
B05-9521-00-xx-NS	Non-shared port
T05-9521-00-xx + RVA-9521-00-NS-B	1 accessory works at a time
T05-9521-00-xx + RVA-9521-PO-NS-B	CAR-3003-36-NS (diverter)

TRIM ONLY

T05-9521-00-xx

CC	KK	LL	BB	NN/YY	VV/TT	GG
468	608	702	702	608	749	1030

ROUGH VALVES Please order **one** of the following rough valves to complete the trim:

RVA-9521-00-B

2-way TP rough - 1/2" male NPT or welded copper connections

685

RVA-9521-PO-B

2-way TP rough - PEX connections

685

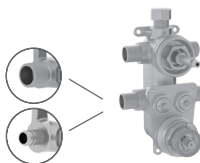

Actual products may differ from pictures. Actual products measures may differ from the measures shown. All USD prices are subject to change without notice. Effective as of August 2023.

B05-9531-00-xx

ROUGH & TRIM PACKAGE

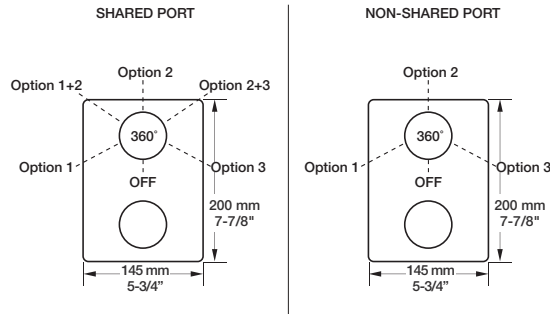

CC	KK	LL	BB	NN/YY	VV/TT	GG
1263	1403	1497	1497	1403	1544	1825

Complete thermostatic pressure balanced shower control valve with 3-way diverter (shared port)

- A- 1 outlet: 7.9 gpm - 60 psi, 2 outlets: 3.7 gpm - 60 psi
- B- Up to 2 accessories can be used at the same time
- C- Thin brass plate
- D- Reversible check / non-return valves in case of water supply inversion
- E- CAR-2661-00 (temperature), CAR-9531-03 (diverter)
- F- Rough valve RVA-9531-00-B included
- G- Large depth adjustment range

Ecological options CEC

Codes	Features
B05-9531-00-xx-NS	Non-shared port
T05-9531-00-xx + RVA-9531-00-NS-B	1 accessory works at a time
T05-9531-00-xx + RVA-9531-PO-NS-B	CAR-9531-03-NS (diverter)

TRIM ONLY

T05-9531-00-xx

CC	KK	LL	BB	NN/YY	VV/TT	GG
468	608	702	702	608	749	1030

ROUGH VALVES Please order **one** of the following rough valves to complete the trim:

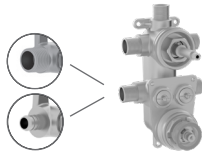

RVA-9531-00-B	3-way TP rough - 1/2" male NPT or welded copper connections	795
RVA-9531-PO-B	3-way TP rough - PEX connections	795

B05-9560-02-xx

ROUGH & TRIM PACKAGE

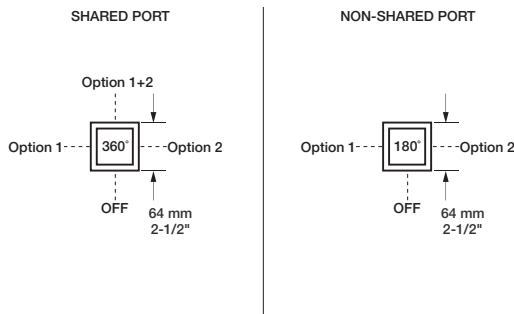

CC	KK	LL	BB	NN/YY	VV/TT	GG
543	616	665	665	616	689	836

Complete 2-port diverter with stop (shared port)

- A- 1 outlet: 10.5 gpm - 60 psi, 2 outlets: 4 gpm - 60 psi
- B- Can replace 2 volume control valves
- C- Up to 2 accessories can be used at the same time
- D- CAR-9525-02
- E- Rough RVA-9562-00-B included
- F- Extra long cartridge for maximum adjustment

Ecological options CEC

Codes	Features
B05-9560-02-xx-NS	Non-shared port
T05-9560-02-xx + RVA-9562-00-NS-B	1 accessory works at a time
	CAR-9525-02-NS (diverter)

TRIM ONLY

T05-9560-02-xx

CC	KK	LL	BB	NN/YY	VV/TT	GG
244	317	366	366	317	390	537

ROUGH VALVE Please order the following rough valve to complete the trim:



RVA-9562-00-B	2-port diverter rough - 1/2" male NPT or welded copper connections	299
----------------------	--------------------------------------------------------------------	------------

Finishes:

CC = chrome, KK = matte black, LL = satin brass, BB = white, NN = brushed nickel, YY = polished nickel, TT = venetian bronze, VV = satin copper, GG = gold **93**

REC B05

B05-9560-03-xx

ROUGH & TRIM PACKAGE

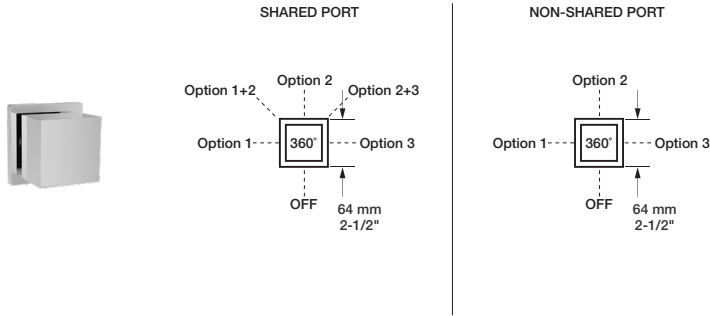

CC	KK	LL	BB	NN/YY	VV/TT	GG
625	698	747	747	698	771	918

Complete 3-port diverter with stop (shared port)

- A- 1 outlet: 9.7 gpm - 60 psi, 2 outlets: 5.2 gpm - 60 psi
- B- Can replace 2 or 3 volume control valves
- C- Up to 2 accessories can be used at the same time
- D- CAR-9530-03
- E- Rough RVA-9563-00-B included
- F- Extra long cartridge for maximum adjustment

Ecological options CEC

Codes	Features
B05-9560-03-xx-NS	Non-shared port
T05-9560-03-xx + RVA-9563-00-NS-B	1 accessory works at a time CAR-9530-03-NS (diverter)

TRIM ONLY

T05-9560-03-xx

CC	KK	LL	BB	NN/YY	VV/TT	GG
244	317	366	366	317	390	537

ROUGH VALVE Please order the following rough valve to complete the trim:

RVA-9563-00-B

3-port diverter rough - inlet: 3/4" F NPT - outlets: 1/2" F NPT

381

B05-9600-00-xx

ROUGH & TRIM PACKAGE



CC	KK	LL	BB	NN/YY	VV/TT	GG
418	491	540	540	491	564	711

Complete 1/2" volume control valve

- A- 7.9 gpm - 60 psi
- B- Volume control valve
- C- CAR-1011-81
- D- Rough valve RVA-2020-01-B included
- E- Extra long cartridge for maximum adjustment

TRIM ONLY

T05-9600-00-xx

CC	KK	LL	BB	NN/YY	VV/TT	GG
244	317	366	366	317	390	537

ROUGH VALVE Please order the following rough valve to complete the trim:

RVA-2020-01-B

Volume control valve rough - 1/2" female NPT connections

174

B05-9649-00-xx

ROUGH & TRIM PACKAGE



CC	KK	LL	BB	NN/YY	VV/TT	GG
479	552	601	601	552	625	772

Complete 3/4" volume control valve

- A- 11.1 gpm - 60 psi
- B- Volume control valve
- C- Offers higher flow
- D- CAR-2719-34
- E- Rough valve RVA-2719-34-B included
- F- Extra long cartridge for maximum adjustment

TRIM ONLY

T05-9649-00-xx

CC	KK	LL	BB	NN/YY	VV/TT	GG
244	317	366	366	317	390	537

ROUGH VALVE Please order the following rough valve to complete the trim:

RVA-2719-34-B

Volume control valve rough - 3/4" female NPT connections

235

Actual products may differ from pictures. Actual products measures may differ from the measures shown. All USD prices are subject to change without notice. Effective as of August 2023.

REC B05

SELECTION OF SHOWER COMPONENTS

For more shower components and for ecological options, please refer to the shower components section (see p. 347-382).

TET-0811-02-xx 8" square shower head  <table border="1"> <thead> <tr> <th>CC</th> <th>KK</th> <th>LL</th> <th>BB</th> </tr> </thead> <tbody> <tr> <td>460</td> <td>598</td> <td>690</td> <td>690</td> </tr> </tbody> </table>	CC	KK	LL	BB	460	598	690	690	TET-1011-01-xx 10" square shower head  <table border="1"> <thead> <tr> <th>CC</th> <th>KK</th> <th>LL</th> <th>BB</th> </tr> </thead> <tbody> <tr> <td>630</td> <td>819</td> <td>945</td> <td>945</td> </tr> </tbody> </table>	CC	KK	LL	BB	630	819	945	945	TET-1214-01-xx 12" square shower head  <table border="1"> <thead> <tr> <th>CC</th> </tr> </thead> <tbody> <tr> <td>595</td> </tr> </tbody> </table>	CC	595	TET-1208-01-xx 12" x 8" rectangular shower head  <table border="1"> <thead> <tr> <th>CC</th> <th>KK</th> </tr> </thead> <tbody> <tr> <td>462</td> <td>601</td> </tr> </tbody> </table>	CC	KK	462	601	BRA-1612-44-xx 16" shower arm  <table border="1"> <thead> <tr> <th>CC</th> <th>KK</th> <th>LL</th> <th>BB</th> </tr> </thead> <tbody> <tr> <td>199</td> <td>259</td> <td>299</td> <td>299</td> </tr> </tbody> </table>	CC	KK	LL	BB	199	259	299	299										
CC	KK	LL	BB																																									
460	598	690	690																																									
CC	KK	LL	BB																																									
630	819	945	945																																									
CC																																												
595																																												
CC	KK																																											
462	601																																											
CC	KK	LL	BB																																									
199	259	299	299																																									
TET-0814-01-xx 8" square shower head  <table border="1"> <thead> <tr> <th>CC</th> </tr> </thead> <tbody> <tr> <td>330</td> </tr> </tbody> </table>	CC	330	TET-1014-01-xx 10" square shower head  <table border="1"> <thead> <tr> <th>CC</th> </tr> </thead> <tbody> <tr> <td>439</td> </tr> </tbody> </table>	CC	439	TET-1614-01-xx 16" square shower head  <table border="1"> <thead> <tr> <th>CC</th> </tr> </thead> <tbody> <tr> <td>832</td> </tr> </tbody> </table>	CC	832	TET-2012-01-xx 20" x 12" rectangular shower head  <table border="1"> <thead> <tr> <th>CC</th> </tr> </thead> <tbody> <tr> <td>965</td> </tr> </tbody> </table>	CC	965	BRA-1812-14-xx 18" shower arm  <table border="1"> <thead> <tr> <th>CC</th> <th>KK</th> <th>LL</th> <th>BB</th> </tr> </thead> <tbody> <tr> <td>188</td> <td>244</td> <td>282</td> <td>282</td> </tr> </tbody> </table>	CC	KK	LL	BB	188	244	282	282																								
CC																																												
330																																												
CC																																												
439																																												
CC																																												
832																																												
CC																																												
965																																												
CC	KK	LL	BB																																									
188	244	282	282																																									
DGL-1670-03-xx 3-spray sliding shower bar  <table border="1"> <thead> <tr> <th>CC</th> <th>KK</th> <th>LL</th> <th>BB</th> </tr> </thead> <tbody> <tr> <td>694</td> <td>902</td> <td>1041</td> <td>1041</td> </tr> </tbody> </table>	CC	KK	LL	BB	694	902	1041	1041	DGL-3070-53-xx 3-spray sliding shower bar  <table border="1"> <thead> <tr> <th>CC</th> <th>KK</th> <th>LL</th> <th>BB</th> </tr> </thead> <tbody> <tr> <td>629</td> <td>818</td> <td>944</td> <td>944</td> </tr> </tbody> </table>	CC	KK	LL	BB	629	818	944	944	DGL-4880-03-xx 3-spray sliding shower bar  <table border="1"> <thead> <tr> <th>CC</th> <th>KK</th> <th>LL</th> <th>BB</th> </tr> </thead> <tbody> <tr> <td>849</td> <td>1104</td> <td>1274</td> <td>1274</td> </tr> </tbody> </table>	CC	KK	LL	BB	849	1104	1274	1274	DSP-2555-20-xx Hand shower on wall-mounted supply elbow  <table border="1"> <thead> <tr> <th>CC</th> <th>KK</th> <th>LL</th> <th>BB</th> </tr> </thead> <tbody> <tr> <td>436</td> <td>567</td> <td>654</td> <td>654</td> </tr> </tbody> </table>	CC	KK	LL	BB	436	567	654	654	RAC-9001-18-xx 1/2" square wall-mount supply elbow  <table border="1"> <thead> <tr> <th>CC</th> <th>KK</th> <th>LL</th> <th>BB</th> </tr> </thead> <tbody> <tr> <td>144</td> <td>187</td> <td>216</td> <td>216</td> </tr> </tbody> </table>	CC	KK	LL	BB	144	187	216	216
CC	KK	LL	BB																																									
694	902	1041	1041																																									
CC	KK	LL	BB																																									
629	818	944	944																																									
CC	KK	LL	BB																																									
849	1104	1274	1274																																									
CC	KK	LL	BB																																									
436	567	654	654																																									
CC	KK	LL	BB																																									
144	187	216	216																																									
BEC-0520-39-xx Square modern tub spout without diverter  <table border="1"> <thead> <tr> <th>CC</th> <th>KK</th> <th>LL</th> <th>BB</th> </tr> </thead> <tbody> <tr> <td>359</td> <td>467</td> <td>539</td> <td>539</td> </tr> </tbody> </table>	CC	KK	LL	BB	359	467	539	539	BEC-0520-83-xx 7" square tub spout without diverter  <table border="1"> <thead> <tr> <th>CC</th> <th>KK</th> <th>LL</th> <th>BB</th> </tr> </thead> <tbody> <tr> <td>198</td> <td>257</td> <td>297</td> <td>297</td> </tr> </tbody> </table>	CC	KK	LL	BB	198	257	297	297	BEC-0520-84-xx 7" square tub spout with diverter  <table border="1"> <thead> <tr> <th>CC</th> <th>KK</th> <th>LL</th> <th>BB</th> </tr> </thead> <tbody> <tr> <td>228</td> <td>296</td> <td>342</td> <td>342</td> </tr> </tbody> </table>	CC	KK	LL	BB	228	296	342	342	BOD-5004-02-xx Square lateral body jet  <table border="1"> <thead> <tr> <th>CC</th> <th>KK</th> <th>LL</th> <th>BB</th> </tr> </thead> <tbody> <tr> <td>248</td> <td>322</td> <td>372</td> <td>372</td> </tr> </tbody> </table>	CC	KK	LL	BB	248	322	372	372	BOD-5006-01-xx Square built-in lateral body jet  <table border="1"> <thead> <tr> <th>CC</th> <th>KK</th> <th>LL</th> <th>BB</th> </tr> </thead> <tbody> <tr> <td>350</td> <td>455</td> <td>525</td> <td>525</td> </tr> </tbody> </table>	CC	KK	LL	BB	350	455	525	525
CC	KK	LL	BB																																									
359	467	539	539																																									
CC	KK	LL	BB																																									
198	257	297	297																																									
CC	KK	LL	BB																																									
228	296	342	342																																									
CC	KK	LL	BB																																									
248	322	372	372																																									
CC	KK	LL	BB																																									
350	455	525	525																																									

Actual products may differ from pictures. Actual products measures may differ from the measures shown. All USD prices are subject to change without notice. Effective as of August 2023.

COMPLETE SHOWER KITS

PRO-1401-03-xx



Complete thermostatic shower kit on square column

CC	KK	LL	BB	NN/YY	VV/TT	GG
2245	2919	3368	3368	2919	3592	4939

Features

- A- Max: 2 gpm - 80 psi (per accessory)
- B- 3-spray hand shower
- C- 2 accessories can work together
- D- Temperature handle on the hot water inlet side, allowing the surface temperature to never exceed the shower water temperature
- E- Shower head arm adjustable up to 20" in height
- F- Thermostatic cartridge: CAR-2661-00
- G- Diverter cartridge: CAR-3003-36

Ecological options	Code	Features are the same, except:
CEC	PRO-1401-03-xx-NS	A- Max: 1.75 gpm - 80 psi (per accessory) C- 1 accessory works at a time G- Diverter cartridge: CAR-3003-36-NS

PRO-2175-95-xx



Complete pressure balanced shower kit

CC	KK	LL	BB	NN/YY	VV/TT	GG
1249	1624	1874	1874	1624	1998	2748

Features

- A- Max: 2 gpm - 80 psi
- B- 3-spray hand shower

Includes

- B05-9100-00-xx** Complete pressure balanced valve
- DGL-3070-53-xx** 3-spray sliding shower bar
- RAC-9001-18-xx** Wall-mount supply elbow

Ecological options	Codes	Features are the same, except:
CEC	PRO-2175-95-xx-175 TRO-2175-95-xx-175 + RVA-9020-00-B	A- Max: 1.75 gpm - 80 psi (hand shower)

TRIM ONLY

TRO-2175-95-xx	CC	KK	LL	BB	NN/YY	VV/TT	GG
	939	1314	1564	1564	1314	1688	2438

ROUGH VALVES Please order **one** of the following rough valves to complete the trim:

RVA-9020-00-B	Type P rough - 1/2" male NPT or welded copper connections	310
RVA-9020-PO-B	Type P rough - PEX connections	310

PRO-2805-95-xx

PRR-2805-95-xx*



Complete pressure balanced shower kit

CC	KK	LL	BB	NN/YY	VV/TT	GG
1989	2586	2984	2984	2586	3182	4376

Features

- A- 2 accessories kit
- B- Max: 2 gpm - 80 psi (per accessory)
- C- 3-spray hand shower
- D- 2 accessories can work together

Includes

- B05-9181-00-xx** Complete type P valve with 2-way diverter
- TET-0811-02-xx** 8" square shower head
- BRA-1612-44-xx** 16" shower arm
- DGL-3070-53-xx** 3-spray sliding shower bar
- RAC-9001-18-xx** Wall-mount supply elbow

Ecological options	Codes	Features are the same, except:
CEC	PRO-2805-95-xx-NS TRO-2805-95-xx-NS + RVA-9181-00-NS-B	B- Max: 1.75 gpm - 80 psi (per accessory) D- 1 accessory works at a time

TRIM ONLY

TRO-2805-95-xx	CC	KK	LL	BB	NN/YY	VV/TT	GG
TRR-2805-95-xx*	1515	2112	2510	2510	2112	2708	3902

ROUGH VALVES Please order **one** of the following rough valves to complete the trim:

RVA-9181-00-B	2-way type P rough - 1/2" male NPT or welded copper connections	310
RVA-9181-PO-B	2-way type P rough - PEX connections	310

Finishes:

CC = chrome, KK = matte black, LL = satin brass, BB = white, NN = brushed nickel, YY = polished nickel, TT = venetian bronze, VV = satin copper, GG = gold

* With 6" ceiling mount shower arm

REC B05

PRO-2815-95-xx PRR-2815-95-xx*



Complete pressure balanced shower kit

CC

1695

Features

- A- 2 accessories kit
- B- Max: 2 gpm - 80 psi (per accessory)
- C- 3-spray hand shower
- D- 2 accessories can work together

Includes

- B05-9181-00-xx** Complete type P valve with 2-way diverter
- TET-0814-01-xx** 8" square shower head
- BRA-1612-44-xx** 16" shower arm
- DGL-3070-53-xx** 3-spray sliding shower bar
- RAC-9001-28-xx** Wall-mount supply elbow

Ecological options CEC

Codes

PRO-2815-95-xx-NS
TRO-2815-95-xx-NS + RVA-9181-00-NS-B

Features are the same, except:

B- Max: 1.75 gpm - 80 psi (per accessory)
D- 1 accessory works at a time

TRIM ONLY

TRO-2815-95-xx
TRR-2815-95-xx*

CC

1221

ROUGH VALVES Please order **one** of the following rough valves to complete the trim:

RVA-9181-00-B

2-way type P rough - 1/2" male NPT or welded copper connections

474

RVA-9181-PO-B

2-way type P rough - PEX connections

474

PRO-2896-05-xx PRR-2896-05-xx*



Complete pressure balanced shower kit

CC	KK	LL	BB	NN/YY	VV/TT	GG
1659	2157	2489	2489	2157	2654	3650

Features

- A- 2 accessories kit
- B- Max: 2 gpm - 80 psi (per accessory)
- C- 1-spray hand shower
- D- 2 accessories can work together

Includes

- B05-9181-00-xx** Complete pressure balanced valve with 2-way diverter
- TET-0811-02-xx** 8" square shower head
- BRA-1612-44-xx** 16" shower arm
- DSP-2555-20-xx** Hand shower on wall-mounted supply elbow

Ecological options CEC

Codes

PRO-2896-05-xx-NS
TRO-2896-05-xx-NS + RVA-9181-00-NS-B

Features are the same, except:

B- Max: 1.75 gpm - 80 psi (per accessory)
D- 1 accessory works at a time

TRIM ONLY

TRO-2896-05-xx
TRR-2896-05-xx*

CC	KK	LL	BB	NN/YY	VV/TT	GG
1121	1600	1919	1919	1600	2078	3035

ROUGH VALVES Please order **one** of the following rough valves to complete the trim:

RVA-9181-00-B

2-way type P rough - 1/2" male NPT or welded copper connections

474

RVA-9181-PO-B

2-way type P rough - PEX connections

474

PRO-3405-05-xx PRR-3405-05-xx*



Complete thermostatic shower kit

CC	KK	LL	BB	NN/YY	VV/TT	GG
2745	3569	4118	4118	3569	4392	6039

Features

- A- 2 accessories kit
- B- Max: 2 gpm - 80 psi (per accessory)
- C- 3-spray hand shower
- D- 2 accessories can work together

Includes

- B05-9404-00-xx** Complete 3/4" thermostatic valve
- B05-9560-02-xx** Complete 2-port diverter with stop
- TET-1011-01-xx** 10" square shower head
- BRA-1614-04-xx** 16" square shower arm
- DGL-3070-53-xx** 3-spray sliding shower bar
- RAC-9001-18-xx** Wall-mount supply elbow

Ecological options CEC

Codes

PRO-3405-05-xx-NS
TRO-3405-05-xx-NS + RVA-3404-00-B + RVA-9562-00-NS-B

Features are the same, except:

B- Max: 1.75 gpm - 80 psi (per accessory)
D- 1 accessory works at a time

TRIM ONLY

TRO-3405-05-xx
TRR-3405-05-xx*

CC	KK	LL	BB	NN/YY	VV/TT	GG
1764	2588	3137	3137	2588	3411	5058

ROUGH VALVES Please order **all** of the following rough valves to complete the trim:

RVA-3404-00-B

Type T rough - 3/4" female NPT connections

682

RVA-9562-00-B

2-port diverter rough - 1/2" male NPT or welded copper connections

299

PRO-4206-05-xx PRR-4206-05-xx*



Complete thermostatic pressure balanced shower kit

CC	KK	LL	BB	NN/YY	VV/TT	GG
2110	2743	3165	3165	2743	3376	4642

Features

- A- 2 accessories kit
- B- Max: 2 gpm - 80 psi (per accessory)
- C- 3-spray hand shower
- D- 2 accessories can work together

Includes

- B05-9521-00-xx** Complete TP shower control valve with 2-way diverter
- TET-0811-02-xx** 8" square shower head
- BRA-1612-44-xx** 16" shower arm
- DGL-3070-53-xx** 3-spray sliding shower bar
- RAC-9001-18-xx** Wall-mount supply elbow

Ecological options CEC

Codes

PRO-4206-05-xx-NS
TRO-4206-05-xx-NS + RVA-9521-00-NS-B

Features are the same, except:

B- Max: 1.75 gpm - 80 psi (per accessory)
D- 1 accessory works at a time

TRIM ONLY

TRO-4206-05-xx TRR-4206-05-xx*

CC	KK	LL	BB	NN/YY	VV/TT	GG
1425	2058	2480	2480	2058	2691	3957

ROUGH VALVES Please order **one** of the following rough valves to complete the trim:

RVA-9521-00-B	2-way TP rough - 1/2" male NPT or welded copper connections	685
RVA-9521-PO-B	2-way TP rough - PEX connections	685

PRO-4216-05-xx PRR-4216-05-xx*



Complete thermostatic pressure balanced shower kit

CC	KK
2225	2893

Features

- A- 2 accessories kit
- B- Max: 2 gpm - 80 psi (per accessory)
- C- 3-spray hand shower
- D- 2 accessories can work together

Includes

- B05-9521-00-xx** Complete TP shower control valve with 2-way diverter
- TET-1208-01-xx** 12" x 8" rectangular shower head
- BRA-1612-44-xx** 16" shower arm
- DGL-3070-53-xx** 3-spray sliding shower bar
- RAC-9001-28-xx** Wall-mount supply elbow

Ecological options CEC

Codes

PRO-4216-05-xx-NS
TRO-4216-05-xx-NS + RVA-9521-00-NS-B

Features are the same, except:

B- Max: 1.75 gpm - 80 psi (per accessory)
D- 1 accessory works at a time

TRIM ONLY

TRO-4216-05-xx TRR-4216-05-xx*

CC	KK
1540	2208

ROUGH VALVES Please order **one** of the following rough valves to complete the trim:

RVA-9521-00-B	2-way TP rough - 1/2" male NPT or welded copper connections	685
RVA-9521-PO-B	2-way TP rough - PEX connections	685

PRO-4225-05-xx PRR-4225-05-xx*



Complete thermostatic pressure balanced shower kit

CC
2369

Features

- A- 2 accessories kit
- B- Max: 2 gpm - 80 psi (per accessory)
- C- 3-spray hand shower
- D- 2 accessories can work together

Includes

- B05-9521-00-xx** Complete TP shower control valve with 2-way diverter
- TET-1214-01-xx** 12" square shower head
- BRA-1614-04-xx** 16" square shower arm
- DGL-3070-53-xx** 3-spray sliding shower bar
- RAC-9001-18-xx** Wall-mount supply elbow

Ecological options CEC

Codes

PRO-4225-05-xx-NS
TRO-4225-05-xx-NS + RVA-9521-00-NS-B

Features are the same, except:

B- Max: 1.75 gpm - 80 psi (per accessory)
D- 1 accessory works at a time

TRIM ONLY

TRO-4225-05-xx TRR-4225-05-xx*

CC
1684

ROUGH VALVES Please order **one** of the following rough valves to complete the trim:

RVA-9521-00-B	2-way TP rough - 1/2" male NPT or welded copper connections	685
RVA-9521-PO-B	2-way TP rough - PEX connections	685

Finishes:

CC = chrome, KK = matte black, LL = satin brass, BB = white, NN = brushed nickel, YY = polished nickel, TT = venetian bronze, VV = satin copper, GG = gold

* With 6" ceiling mount shower arm

REC B05

PRO-4296-05-xx PRR-4296-05-xx*



Complete thermostatic pressure balanced shower kit

CC	KK	LL	BB	NN/YY	VV/TT	GG
1954	2540	2931	2931	2540	3126	4299

Features

- A- 2 accessories kit
- B- Max: 2 gpm - 80 psi (per accessory)
- C- 3-spray hand shower
- D- 2 accessories can work together

Includes

- B05-9521-00-xx** Complete TP shower control valve with 2-way diverter
- TET-1011-01-xx** 10" square shower head
- BRA-1612-44-xx** 16" shower arm
- DSP-2555-20-xx** Hand shower on wall-mounted supply elbow

Ecological options CEC

Codes

PRO-4296-05-xx-NS
TRO-4296-05-xx-NS + RVA-9521-00-NS-B

Features are the same, except:

B- Max: 1.75 gpm - 80 psi (per accessory)
D- 1 accessory works at a time

TRIM ONLY

TRO-4296-05-xx TRR-4296-05-xx*

CC	KK	LL	BB	NN/YY	VV/TT	GG
1269	1855	2246	2246	1855	2441	3614

ROUGH VALVES Please order **one** of the following rough valves to complete the trim:

RVA-9521-00-B	2-way TP rough - 1/2" male NPT or welded copper connections	685
----------------------	-------------------------------------------------------------	------------

RVA-9521-P0-B	2-way TP rough - PEX connections	685
----------------------	----------------------------------	------------

PRO-4306-05-xx PRR-4306-05-xx*



Complete thermostatic pressure balanced shower kit

CC	KK	LL	BB	NN/YY	VV/TT	GG
2520	3276	3780	3780	3276	4032	5544

Features

- A- 3 accessories kit
- B- 7.9 gpm - 60 psi (bath spout)
- C- Max: 2 gpm - 80 psi (shower accessories)
- D- 3-spray hand shower
- E- 2 accessories can work together

Includes

- B05-9531-00-xx** Complete TP shower control valve with 3-way diverter
- BEC-0520-39-xx** Square modern tub spout without diverter
- TET-0811-02-xx** 8" square shower head
- BRA-1612-44-xx** 16" shower arm
- DGL-3070-53-xx** 3-spray sliding shower bar
- RAC-9001-18-xx** Wall-mount supply elbow

Ecological options CEC

Codes

PRO-4306-05-xx-NS
TRO-4306-05-xx-NS + RVA-9531-00-NS-B

Features are the same, except:

C- Max: 1.75 gpm - 80 psi (shower accessories)
E- 1 accessory works at a time

TRIM ONLY

TRO-4306-05-xx TRR-4306-05-xx*

CC	KK	LL	BB	NN/YY	VV/TT	GG
1725	2481	2985	2985	2481	3237	4749

ROUGH VALVES Please order **one** of the following rough valves to complete the trim:

RVA-9531-00-B	3-way TP rough - 1/2" male NPT or welded copper connections	795
----------------------	-------------------------------------------------------------	------------

RVA-9531-P0-B	3-way TP rough - PEX connections	795
----------------------	----------------------------------	------------

PRO-4395-05-xx PRR-4395-05-xx*



Complete thermostatic pressure balanced shower kit

CC	KK	LL	BB	NN/YY	VV/TT	GG
3075	3998	4613	4613	3998	4920	6765

Features

- A- 3 accessories kit
- B- Max: 2 gpm - 80 psi (per accessory)
- C- 4.5 gpm for 3 body jets
- D- 3-spray hand shower
- E- 2 accessories can work together

Includes

- B05-9531-00-xx** Complete TP shower control valve with 3-way diverter
- TET-1011-01-xx** 10" square shower head
- BRA-1614-04-xx** 16" square shower arm
- DGL-3070-53-xx** 3-spray sliding shower bar
- RAC-9001-18-xx** Wall-mount supply elbow
- BOD-5004-02-xx** Square lateral body jet (3)

TRIM ONLY

TRO-4395-05-xx TRR-4395-05-xx*

CC	KK	LL	BB	NN/YY	VV/TT	GG
2280	3203	3818	3818	3203	4125	5970

ROUGH VALVES Please order **one** of the following rough valves to complete the trim:

RVA-9531-00-B	3-way TP rough - 1/2" male NPT or welded copper connections	795
----------------------	-------------------------------------------------------------	------------

RVA-9531-P0-B	3-way TP rough - PEX connections	795
----------------------	----------------------------------	------------

Actual products may differ from pictures. Actual products measures may differ from the measures shown. All USD prices are subject to change without notice. Effective as of August 2023.

SELECTION OF BATHROOM ACCESSORIES

For more bathroom accessories, please refer to the bathroom accessories section (see p. 293-306).

A44-1029-00-xx

FLAT
Square wall-mounted toilet paper holder



CC	KK	LL	BB	NN/YY	VV/TT	GG
144	187	216	216	187	230	317

A44-1069-00-xx

FLAT
Square bathrobe holder



CC	KK	LL	BB	NN/YY	VV/TT	GG
90	117	135	135	117	144	198

A44-6017-00-xx

FLAT
25" square single towel bar



CC	KK	LL	BB	NN/YY	VV/TT	GG
248	323	372	372	323	397	546

A44-6027-00-xx

FLAT
Square double towel bar



CC	KK	LL	BB	NN/YY	VV/TT	GG
298	387	447	447	387	477	656

A85-2009-40-xx

Towel holder on stand



CC
523

A85-3179-00-xx

Shower squeegee



CC
173

A85-9019-00-xx

Hanging hook for shower



CC
121

Finishes:

OVAL B14

Compatible with the Touchless Sensor
Order ELE-2001-01-xx (p. 43)



BARIL

OVAL B14

B14-1010-1PL-xx

DRAIN INCLUDED

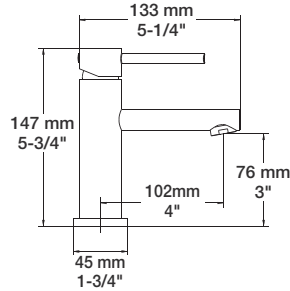

DRAIN NOT INCLUDED

B14-1010-01L-xx

D- Order your lavatory drain (pages 309-310)

CC	KK	LL	BB	NN/YY	VV/TT	GG
670	871	1005	1005	871	1072	1474

Single-hole lavatory faucet, drain included

- A- 1.5 gpm - 60 psi
- B- Adjustable aerator
- C- CAR-1025-09
- D- Push-button drain with overflow included

Ecological options

Codes	Reduced flow rates	CEC
B14-1010-XXL-xx-120	1.2 gpm (4.5 l/min) - 60 psi	
B14-1010-XXL-xx-100	1.0 gpm (3.7 l/min) - 60 psi	
B14-1010-XXL-xx-050	0.5 gpm (1.9 l/min) - 60 psi	

CC	KK	LL	BB	NN/YY	VV/TT	GG
622	808	933	933	808	995	1363

B14-1020-00L-xx

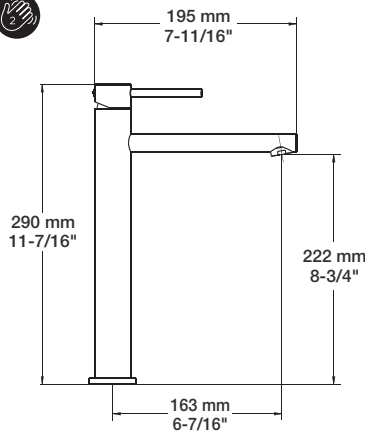

CC	KK	LL	BB	NN/YY	VV/TT	GG
734	954	1101	1101	954	1174	1615

High single-hole lavatory faucet, drain not included

- A- 1.5 gpm - 60 psi
- B- Order your lavatory drain (pages 309-310)
- C- Adjustable aerator
- D- CAR-1025-09

Ecological options

Codes	Reduced flow rates	CEC
B14-1020-00L-xx-120	1.2 gpm (4.5 l/min) - 60 psi	
B14-1020-00L-xx-100	1.0 gpm (3.7 l/min) - 60 psi	
B14-1020-00L-xx-050	0.5 gpm (1.9 l/min) - 60 psi	

B14-8009-00L-xx

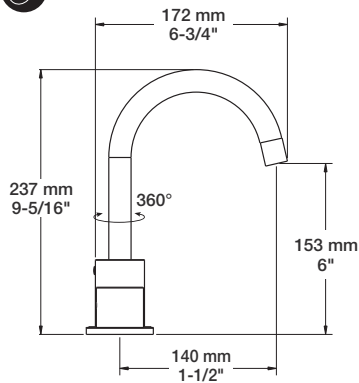

CC	KK	LL	BB	NN/YY	VV/TT	GG
924	1202	1387	1387	1202	1479	2034

8" c/c lavatory faucet, drain included

- A- 1.5 gpm - 60 psi
- B- Drain included
- C- Swivel spout
- D- CAR-1020-01 (Cold), CAR-1020-02 (Hot)

Ecological options

Codes	Reduced flow rates	CEC
B14-8009-00L-xx-120	1.2 gpm (4.5 l/min) - 60 psi	
B14-8009-00L-xx-100	1.0 gpm (3.7 l/min) - 60 psi	
B14-8009-00L-xx-050	0.5 gpm (1.9 l/min) - 60 psi	

B14-1329-00-xx

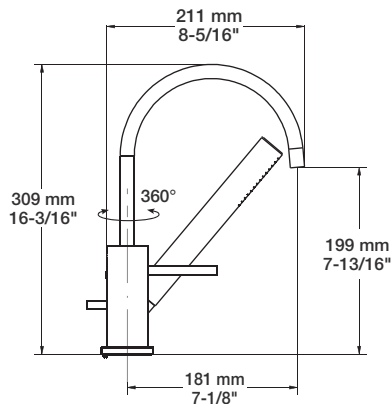

CC	KK	LL	BB	NN/YY	VV/TT	GG
1242	1615	1863	1863	1615	1988	2733

3-piece tub filler with hand shower

Bath spout:

- A- 6.9 gpm - 60 psi
- B- Swivel spout

Hand shower:

- C- Max: 2 gpm - 80 psi
- D- Hand shower - 2 choices of installation
- E- DOU-2550-01-xx
- F- CAR-1031-49

Ecological options

Codes	Reduced flow rates	CEC
B14-1329-00-xx-150	5.7 l/min (1.5 gpm) - 80 psi	
B14-1329-00-xx-175	6.6 l/min (1.75 gpm) - 80 psi	

Actual products may differ from pictures. Actual products measures may differ from the measures shown. All USD prices are subject to change without notice. Effective as of August 2023.

OVAL B14

B14-9180-00-xx

ROUGH & TRIM PACKAGE

CC	KK	LL	BB	NN/YY	VV/TT	GG
994	1150	1254	1254	1150	1306	1618

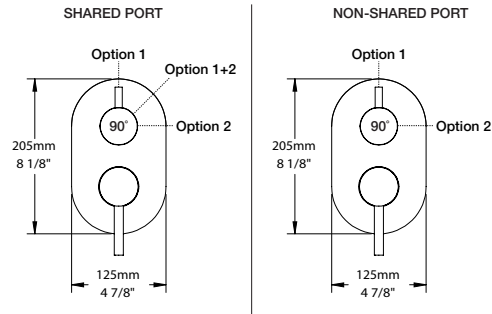

Complete pressure balanced shower control valve with 2-way diverter (shared port)

- A- 1 outlet: 5 gpm - 60 psi, 2 outlets: 2.6 gpm - 60 psi
- B- Volume control valve
- C- Up to 2 accessories can be used at the same time
- D- CAR-1020-40 (volume), CAR-1001-35 (diverter)
- E- Rough valve RVA-9181-00-B included

Ecological options CEC

Codes	Features
B14-9180-00-xx-NS	Non-shared port
T14-9180-00-xx + RVA-9181-00-NS-B	1 accessory works at a time
T14-9180-00-xx + RVA-9181-P0-NS-B	CAR-1001-35-NS (diverter)

TRIM ONLY

T14-9180-00-xx

CC	KK	LL	BB	NN/YY	VV/TT	GG
520	676	780	780	676	832	1144

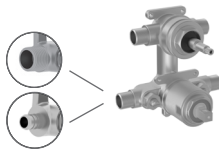

ROUGH VALVES Please order **one** of the following rough valves to complete the trim:

RVA-9181-00-B	2-way type P rough - 1/2" male NPT or welded copper connections	474
RVA-9181-P0-B	2-way type P rough - PEX connections	474

OVAL B14

Finishes:

CC = chrome, KK = matte black, LL = satin brass, BB = white, NN = brushed nickel, YY = polished nickel, TT = venetian bronze, VV = satin copper, GG = gold 105

OVAL B14

SELECTION OF SHOWER COMPONENTS

For more shower components and for ecological options, please refer to the shower components section (see p. 347-382).

TET-0810-01-xx
8" round shower head



CC	KK	LL	BB
445	579	668	668

TET-1010-01-xx
10" round shower head



CC	KK	LL	BB
575	748	863	863

BRA-1812-02-xx
18" wall mount shower arm



CC	KK	LL	BB

RAC-0618-02-xx
6" ceiling mount shower arm



CC	KK	LL	BB

DGL-2070-53-xx
3-spray sliding shower bar



CC	KK	LL	BB
548	712	822	822

DGL-2175-52-xx
3-spray sliding shower bar with built-in supply elbow



CC	KK	LL	BB
543	706	815	815

DGL-2175-53-xx
3-spray sliding shower bar



CC	KK	LL	BB
468	608	702	702

RAC-9201-02-xx
1/2"F wall-mount supply elbow with integrated volume control



CC	KK	LL	BB
199	259	299	299

RAC-9001-13-xx
1/2"F wall-mount supply elbow



CC	KK	LL	BB
88	114	132	132

RAC-9001-16-xx
1/2"F wall-mount supply elbow



CC	KK	LL	BB
124	161	186	186

BOD-5007-01-xx
Round built-in lateral body jet



CC	KK	LL	BB
325	423	488	488

BEC-0520-26-xx
7" tub spout without diverter



CC	KK	LL	BB
99	129	149	149

BEC-0520-45-xx
Sens tub spout without diverter



CC	KK	LL	BB
424	551	636	636

Actual products may differ from pictures. Actual products measures may differ from the measures shown. All USD prices are subject to change without notice. Effective as of August 2023.

COMPLETE SHOWER KITS

PRO-1100-53-xx



Complete thermostatic shower kit on column

CC	KK	LL	BB	NN/YY	VV/TT	GG
1775	2308	2663	2663	2308	2840	3905

Features

- A- Max: 2 gpm - 80 psi (per accessory)
- B- 3-spray push-button hand shower
- C- 2 accessories can work together
- D- Temperature handle on the hot water inlet side, allowing the surface temperature to never exceed the shower water temperature
- E- Shower head arm adjustable up to 20" in height
- F- Easy to move metal slider with built-in hook
- G- Thermostatic cartridge: CAR-2661-00
- H- Diverter cartridge: CAR-3003-36

Ecological options	CEC	Code	Features are the same, except:
		PRO-1100-53-xx-NS	A- Max: 1.75 gpm - 80 psi (per accessory) C- 1 accessory works at a time G- Diverter cartridge: CAR-3003-36-NS

PRO-2800-14-xx PRR-2800-14-xx*



Complete pressure balanced shower kit

CC	KK	LL	BB	NN/YY	VV/TT	GG
1825	2373	2738	2738	2373	2920	4015

Features

- A- 2 accessories kit
- B- Max: 2 gpm - 80 psi (per accessory)
- C- 3-spray hand shower
- D- 2 accessories can work together

Incluant

- B14-9180-00-xx** Complete type P valve with 2-way diverter
- TET-0810-01-xx** 8" round shower head
- BRA-1812-02-xx** 18" shower arm
- DGL-2175-53-xx** 3-spray sliding shower bar
- RAC-9001-16-xx** Wall-mount supply elbow

Ecological options	CEC	Codes	Features are the same, except:
		PRO-2800-14-xx-NS	B- Max: 1.75 gpm - 80 psi (per accessory)
		TRO-2800-14-xx-NS + RVA-9181-00-NS-B	D- 1 accessory works at a time

TRIM ONLY

TRO-2800-14-xx TRR-2800-14-xx*	CC	KK	LL	BB	NN/YY	VV/TT	GG
	1351	1899	2264	2264	1899	2446	3541

ROUGH VALVES Please order **one** of the following rough valves to complete the trim:

RVA-9181-00-B	2-way type P rough - 1/2" male NPT or welded copper connections	474
RVA-9181-PO-B	2-way type P rough - PEX connections	474

Finishes:

CC = chrome, KK = matte black, LL = satin brass, BB = white, NN = brushed nickel, YY = polished nickel, TT = venetian bronze, VV = satin copper, GG = gold

* With 6" ceiling mount shower arm

OVAL B14

SELECTION OF BATHROOM ACCESSORIES

For more bathroom accessories, please refer to the bathroom accessories section (see p. 293-306).

A04-1029-00-xx

PETITE
Wall-mounted toilet paper holder



CC	KK	LL	BB	NN/YY	VV/TT	GG
197	256	296	296	256	315	433

A04-1069-00-xx

PETITE
Bathrobe holder



CC	KK	LL	BB	NN/YY	VV/TT	GG
92	120	138	138	120	147	202

A04-6012-00-xx

PETITE
12" single towel bar

Available Q3 2023



CC	KK	LL	BB	NN/YY	VV/TT	GG
245	319	368	368	319	392	539

A04-6018-00-xx

PETITE
18" single towel bar



CC	KK	LL	BB	NN/YY	VV/TT	GG
275	358	413	413	358	440	605

A04-6024-00-xx

PETITE
24" single towel bar



CC	KK	LL	BB	NN/YY	VV/TT	GG
305	397	458	458	397	488	671

A04-6030-00-xx

PETITE
30" single towel bar



CC	KK	LL	BB	NN/YY	VV/TT	GG
385	501	578	578	501	616	847

A85-3179-00-xx

Shower squeegee



CC
173

A85-9077-00-xx

Corner basket



CC
248

Actual products may differ from pictures. Actual products measures may differ from the measures shown. All USD prices are subject to change without notice. Effective as of August 2023.

NAUTICA B16 B18

Compatible with the Touchless Sensor
Order ELE-2001-01-xx (p. 43)



BARIL

NAUTICA B16 B18

B1X-8001-XXL-xx

B16-8001-01L-xx

NAUTICA



CC	KK	LL	BB	NN/YY	VV/TT	GG
780	1014	1170	1170	1014	1248	1716

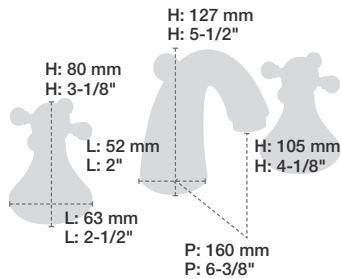

B18-8001-00L-xx

RALPH



CC/CB	KK/KB	LL/LB	BB	NN/NB YY/YB	VV/VB TT/TB	GG/GB
780	1014	1170	1170	1014	1248	1716

8" c/c lavatory faucet, drain included

- A- 1.5 gpm - 60 psi
- B- Drain included
- C- Adjustable aerator
- D- CAR-1020-01 (Cold), CAR-1020-02 (Hot)

Ecological options

Codes	Reduced flow rates	CEC
B1X-8001-XXL-xx-120	1.2 gpm (4.5 l/min) - 60 psi	
B1X-8001-XXL-xx-100	1.0 gpm (3.7 l/min) - 60 psi	
B1X-8001-XXL-xx-050	0.5 gpm (1.9 l/min) - 60 psi	

B1X-8041-00L-xx

B16-8041-00L-xx

NAUTICA



CC	KK	LL	BB	NN/YY	VV/TT	GG
1011	1314	1517	1517	1314	1618	2225

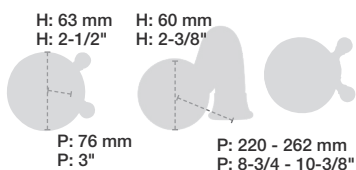

B18-8041-00L-xx

RALPH



CC/CB	KK/KB	LL/LB	BB	NN/NB YY/YB	VV/VB TT/TB	GG/GB
1011	1314	1517	1517	1314	1618	2225

Wall-mounted lavatory faucet, drain not included

- A- 1.5 gpm - 60 psi
- B- Slip-on spout for easier adjustment
- C- Single piece rough for easy installation
- D- Order your lavatory drain (pages 309-310)
- E- Adjustable aerator
- F- CAR-1011-80 (Cold), CAR-1011-81 (Hot)

Ecological options

Codes	Reduced flow rates	CEC
B1X-8041-00L-xx-120	1.2 gpm (4.5 l/min) - 60 psi	
B1X-8041-00L-xx-100	1.0 gpm (3.7 l/min) - 60 psi	
B1X-8041-00L-xx-050	0.5 gpm (1.9 l/min) - 60 psi	

Actual products may differ from pictures. Actual products measures may differ from the measures shown. All USD prices are subject to change without notice. Effective as of August 2023.

NAUTICA B16 B18

B1X-1201-01-xx

B16-1201-01-xx

NAUTICA



CC	KK	LL	BB	NN/YY	VV/TT	GG
1150	1495	1725	1725	1495	1840	2531

B18-1201-01-xx

RALPH



CC/CB	KK/KB	LL/LB	BB	NN/NB YY/YB	VV/VB TT/TB	GG/GB
1150	1495	1725	1725	1495	1840	2531

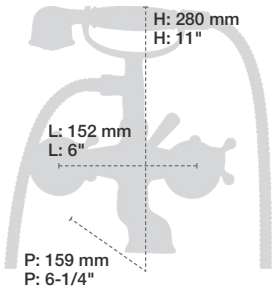

Wall-mounted tub faucet with hand shower

Bath spout:

- A- 6 gpm - 60 psi
- B- Vertical closed position of the handles
- C- Ceramic diverter cartridge CAR-1219-02
- D- CAR-1020-01 (Cold), CAR-1020-02 (Hot)

Hand shower:

- E- Max: 2 gpm - 80 psi
- F- DOU-1219-01-xx metal hand shower
- G- 59" (150 cm) double interlock flexible hose, rotating nut with 2 non-return valves

Ecological options

Codes	Reduced flow rates
B1X-1201-01-xx-150	1.5 gpm (5.7 l/min) - 80 psi
B1X-1201-01-xx-175	1.75 gpm (6.6 l/min) - 80 psi

CEC

NAUTICA
B16 B18

B1X-9404-00-xx

ROUGH & TRIM PACKAGE

B16-9404-00-xx

NAUTICA



CC	KK	LL	BB	NN/YY	VV/TT	GG
1243	1411	1524	1524	1411	1580	1916

B18-9404-00-xx

RALPH



CC/CB	KK/KB	LL/LB	BB	NN/NB YY/YB	VV/VB TT/TB	GG/GB
1243	1411	1524	1524	1411	1580	1916

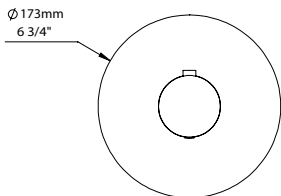

Complete 3/4" thermostatic valve

- A- 16 gpm - 60 psi
- B- Separate volume control or diverter valve required
- C- Can easily supply 3 accessories

- D- CAR-3404-00
- E- Rough valve RVA-3404-00-B included
- F- Reversible check / non-return valves in case of water supply inversion

TRIM ONLY

T16-9404-00-xx	NAUTICA	CC	KK	LL	BB	NN/YY	VV/TT	GG
		561	729	842	842	729	898	1234
T18-9404-00-xx	RALPH	CC/CB	KK/KB	LL/LB	BB	NN/NB YY/YB	VV/VB TT/TB	GG/GB
		561	729	842	842	729	898	1234

ROUGH VALVE Please order the following rough valve to complete the trim:

RVA-3404-00-B	Type T rough - 3/4" female NPT connections	682
---------------	--------------------------------------------	-----

Finishes :

CC = chrome, KK = matte black, LL = satin brass, BB = white, NN = brushed nickel, YY = polished nickel, TT = venetian bronze, VV = satin copper, GG = gold, CB = chrome white, KB = matte black white, LB = satin brass white, NB = brushed nickel white, YB = polished nickel white, TB = venetian bronze white, VB = satin copper, GB = gold white

NAUTICA B16 B18

B1X-9560-02-xx

ROUGH & TRIM PACKAGE

B16-9560-02-xx

NAUTICA



CC	KK	LL	BB	NN/YY	VV/TT	GG
586	672	730	730	672	758	930

B18-9560-02-xx

RALPH



CC/CB	KK/KB	LL/LB	BB	NN/NB YY/YB	VV/VB TT/TB	GG/GB
586	672	730	730	672	758	930

SHARED PORT

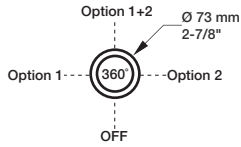

NON-SHARED PORT

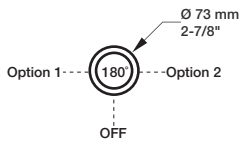

Complete 2-port diverter with off (shared port)

- A- 1 outlet: 10.5 gpm - 60 psi
- A- 2 outlets: 4 gpm - 60 psi
- B- Can replace 2 volume control valves

- C- Up to 2 accessories can be used at the same time
- D- CAR-9525-02
- E- Rough RVA-9562-00-B included
- F- Extra long cartridge for maximum adjustment

Ecological options CEC

Codes	Features
B1X-9560-02-xx-NS	Non-shared port
T1X-9560-02-xx + RVA-9562-00-NS-B	1 accessory works at a time CAR-9525-02-NS (diverter)

TRIM ONLY

T16-9560-02-xx	NAUTICA	CC	KK	LL	BB	NN/YY	VV/TT	GG
		287	373	431	431	373	459	631

T18-9560-02-xx	RALPH	CC/CB	KK/KB	LL/LB	BB	NN/NB YY/YB	VV/VB TT/TB	GG/GB
		287	373	431	431	373	459	631

ROUGH VALVE Please order the following rough valve to complete the trim:

RVA-9562-00-B	2-port diverter rough - 1/2" male NPT or welded copper connections	299
----------------------	--------------------------------------------------------------------	-----

B1X-9560-03-xx

ROUGH & TRIM PACKAGE

B16-9560-03-xx

NAUTICA



CC	KK	LL	BB	NN/YY	VV/TT	GG
668	754	812	812	754	840	1012

B18-9560-03-xx

RALPH



CC/CB	KK/KB	LL/LB	BB	NN/NB YY/YB	VV/VB TT/TB	GG/GB
668	754	812	812	754	840	1012

SHARED PORT

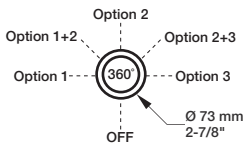

NON-SHARED PORT

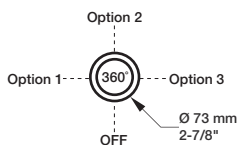

Complete 3-port diverter with off (shared port)

- A- 1 outlet: 9.7 gpm - 60 psi
- A- 2 outlets: 5.2 gpm - 60 psi
- B- Can replace 2 or 3 volume control valves

- C- Up to 2 accessories can be used at the same time
- D- CAR-9530-03
- E- Rough RVA-9563-00-B included
- F- Extra long cartridge for maximum adjustment

Ecological options CEC

Codes	Features
B1X-9560-03-xx-NS	Non-shared port
T1X-9560-03-xx + RVA-9563-00-NS-B	1 accessory works at a time CAR-9530-03-NS (diverter)

TRIM ONLY

T16-9560-03-xx	NAUTICA	CC	KK	LL	BB	NN/YY	VV/TT	GG
		287	373	431	431	373	459	631

T18-9560-03-xx	RALPH	CC/CB	KK/KB	LL/LB	BB	NN/NB YY/YB	VV/VB TT/TB	GG/GB
		287	373	431	431	373	459	631

ROUGH VALVE Please order the following rough valve to complete the trim:

RVA-9563-00-B	3-port diverter rough - inlet: 3/4" F NPT - outlets: 1/2" F NPT	381
----------------------	-----------------------------------------------------------------	-----

NAUTICA B16 B18

NAUTICA
B16 B18

B1X-9601-00-xx

ROUGH & TRIM PACKAGE

B16-9601-00-xx

NAUTICA



CC	KK	LL	BB	NN/YY	VV/TT	GG
461	547	605	605	547	633	805

B18-9601-00-xx

RALPH



CC/CB	KK/KB	LL/LB	BB	NN/NB YY/YB	VV/VB TT/TB	GG/GB
461	547	605	605	547	633	805

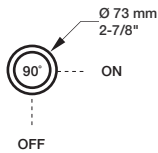

Complete 1/2" volume control valve

- A- 7.9 gpm - 60 psi
- B- Volume control valve
- C- CAR-1011-81
- D- Rough valve RVA-2020-01-B included
- E- Extra long cartridge for maximum adjustment

TRIM ONLY

T16-9601-00-xx	NAUTICA	CC	KK	LL	BB	NN/YY	VV/TT	GG
		287	373	431	431	373	459	631

T18-9601-00-xx	RALPH	CC/CB	KK/KB	LL/LB	BB	NN/NB YY/YB	VV/VB TT/TB	GG/GB
		287	373	431	431	373	459	631

ROUGH VALVE Please order the following rough valve to complete the trim:

RVA-2020-01-B	Volume control valve rough - 1/2" female NPT connections	174
---------------	----------------------------------------------------------	-----

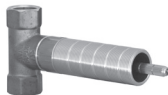

B1X-9641-00-xx

ROUGH & TRIM PACKAGE

B16-9641-00-xx

NAUTICA



CC	KK	LL	BB	NN/YY	VV/TT	GG
522	608	666	666	608	694	866

B18-9641-00-xx

RALPH



CC/CB	KK/KB	LL/LB	BB	NN/NB YY/YB	VV/VB TT/TB	GG/GB
522	608	666	666	608	694	866

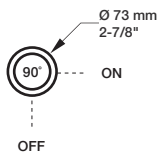

Complete 3/4" volume control valve

- A- 11.1 gpm - 60 psi
- B- Volume control valve
- C- Offers higher flow
- D- CAR-2719-34
- E- Rough valve RVA-2719-34-B included
- F- Extra long cartridge for maximum adjustment

TRIM ONLY

T16-9641-00-xx	NAUTICA	CC	KK	LL	BB	NN/YY	VV/TT	GG
		287	373	431	431	373	459	631

T18-9641-00-xx	RALPH	CC/CB	KK/KB	LL/LB	BB	NN/NB YY/YB	VV/VB TT/TB	GG/GB
		287	373	431	431	373	459	631

ROUGH VALVE Please order the following rough valve to complete the trim:

RVA-2719-34-B	Volume control valve rough - 3/4" female NPT connections	235
---------------	----------------------------------------------------------	-----



Finishes :

CC = chrome, KK = matte black, LL = satin brass, BB = white, NN = brushed nickel, YY = polished nickel, TT = venetian bronze, VV = satin copper, GG = gold, CB = chrome white, KB = matte black white, LB = satin brass white, NB = brushed nickel white, YB = polished nickel white, TB = venetian bronze white, VB = satin copper, GB = gold white

NAUTICA B16 B18

SELECTION OF SHOWER COMPONENTS

For more shower components and for ecological options, please refer to the shower components section (see p. 347-382).

TET-0810-01-xx
8" round shower head



CC	KK	LL	BB
445	579	668	668

TET-1210-01-xx
12" round shower head



CC	KK	LL	BB
750	975	1125	1125

BRA-1812-02-xx
18" shower arm



CC	KK	LL	BB
168	218	252	252

RAC-0618-02-xx
6" ceiling mount shower arm



CC	KK	LL	BB
68	88	102	102

TET-1616-01-xx
16" round shower head



CC	KK	LL	BB
1195	1554	1793	1793

TET-0812-03-xx
8" sunflower shower head



CC	KK	LL	BB
495	644	743	743

RAC-9001-13-xx
1/2"F wall-mount supply elbow



CC	KK	LL	BB
88	114	132	132

RAC-9001-16-xx
1/2"F wall-mount supply elbow



CC	KK	LL	BB
124	161	186	186

DGL-2160-04-xx
4-spray sliding shower bar



CC	KK	LL	BB
798	1037	1197	1197

BOD-5001-00-xx
Lateral body jet



CC	KK	LL	BB
139	181	209	209

BOD-5007-01-xx
Round built-in lateral body jet



CC	KK	LL	BB
325	423	488	488

Actual products may differ from pictures. Actual products measures may differ from the measures shown. All USD prices are subject to change without notice. Effective as of August 2023.

COMPLETE SHOWER KITS

PRO-1100-16-xx

Complete thermostatic shower kit on column

CC	KK	LL	BB	NN/YY	VV/TT	GG
2495	3244	3743	3743	3244	3992	5489



Features

- A- Max: 2 gpm - 80 psi (per accessory)
- B- 3-spray hand shower
- C- 2 accessories can work together
- D- Temperature handle on the hot water inlet side, allowing the surface temperature to never exceed the shower water temperature
- E- Shower head arm adjustable up to 20" in height
- F- Easy to move metal slider with built-in hook
- G- Thermostatic cartridge: CAR-2660-00
- H- Diverter cartridge: CAR-3003-36

Ecological options	Code	Features are the same, except:
CEC	PRO-1100-16-xx-NS	A- Max: 1.75 gpm - 80 psi (per accessory) C- 1 accessory works at a time H- Diverter cartridge: CAR-3003-36-NS

PRO-3420-16-xx

PRR-3420-16-xx*

Complete thermostatic shower kit

CC	KK	LL	BB	NN/YY	VV/TT	GG
2345	3049	3518	3518	3049	3752	5159



Features

- A- 2 accessories kit
- B- Max: 2 gpm - 80 psi (per accessory)
- C- 3-spray hand shower
- D- 2 accessories can work together

Includes

- B16-9404-00-xx** Complete 3/4" thermostatic valve
- B16-9560-02-xx** Complete 2-port diverter with off
- TET-0810-01-xx** 8" round shower head
- BRA-1812-02-xx** 18" shower arm
- DGL-2170-63-xx** 3-spray sliding shower bar
- RAC-9001-13-xx** Wall-mount supply elbow

Ecological options	Codes	Features are the same, except:
CEC	PRO-3420-16-xx-NS TRO-3420-16-xx-NS + RVA-3404-00-B + RVA-9562-00-NS-B	B- Max: 1.75 gpm - 80 psi (per accessory) D- 1 accessory works at a time

TRIM ONLY

TRO-3420-16-xx	CC	KK	LL	BB	NN/YY	VV/TT	GG
TRR-3420-16-xx*	1364	2068	2537	2537	2068	2771	4178

ROUGH VALVES Please order **all** of the following rough valves to complete the trim:

RVA-3404-00-B	Type T rough - 3/4" female NPT connections	682
RVA-9562-00-B	2-port diverter rough - 1/2" male NPT or welded copper connections	299

* With 6" ceiling mount shower arm

Finishes :

CC = chrome, KK = matte black, LL = satin brass, BB = white, NN = brushed nickel, YY = polished nickel, TT = venetian bronze, VV = satin copper, GG = gold, CB = chrome white, KB = matte black white, LB = satin brass white, NB = brushed nickel white, YB = polished nickel white, TB = venetian bronze white, VB = satin copper, GB = gold white

NAUTICA B16 B18

PRO-3420-18-xx PRR-3420-18-xx*

Complete thermostatic shower kit

CC/CB	KK/KB	LL/LB	BB	NN/NB YY/YB	VV/VB TT/TB	GG/GB
2345	3049	3518	3518	3049	3752	5159



Features

- A- 2 accessories kit
- B- Max: 2 gpm - 80 psi (per accessory)
- C- 3-spray hand shower
- D- 2 accessories can work together

Includes

- B18-9404-00-xx** Complete 3/4" thermostatic valve
- B18-9560-02-xx** Complete 2-port diverter with off
- TET-0810-01-xx** 8" round shower head
- BRA-1812-02-xx** 18" shower arm
- DGL-2170-63-xx** 3-spray sliding shower bar
- RAC-9001-13-xx** Wall-mount supply elbow

Ecological options CEC

Codes

- PRO-3420-18-xx-NS
- TRO-3420-18-xx-NS + RVA-3404-00-B +
- RVA-9562-00-NS-B

Features are the same, **except:**

- B- Max: 1.75 gpm - 80 psi (per accessory)
- D- 1 accessory works at a time

TRIM ONLY

TRO-3420-18-xx TRR-3420-18-xx*

CC/CB	KK/KB	LL/LB	BB	NN/NB YY/YB	VV/VB TT/TB	GG/GB
1364	2068	2537	2537	2068	2771	4178

ROUGH VALVES Please order **all** of the following rough valves to complete the trim:

RVA-3404-00-B

Type T rough - 3/4" female NPT connections

682

RVA-9562-00-B

2-port diverter rough - 1/2" male NPT or welded copper connections

299

HAÜS B26 B27 B28

Compatible with the Touchless Sensor
Order ELE-2001-01-xx (p. 43)



BARIL

HAÜS B26 B27 B28

B2X-8000-00L-xx

B26-8000-00L-CD HAÜS-D



CD

1298

B27-8000-00L-xx HAÜS-C



CC KK LL BB NN/YY VV/TT GG

1074 1397 1611 1611 1397 1719 2363

B28-8000-00L-xx HAÜS-L



CC KK LL BB NN/YY VV/TT GG

1074 1397 1611 1611 1397 1719 2363

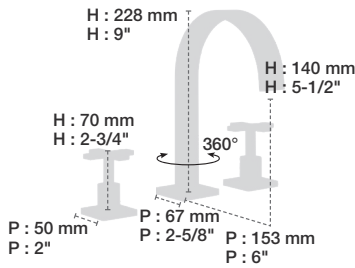

8" c/c lavatory faucet, drain not included

- A- 1.5 gpm - 60 psi
- B- Order your lavatory drain (pages 309-310)
- C- Cascade-type spout
- D- Swivel spout
- E- CAR-1020-01 (Cold), CAR-1020-02 (Hot)

Ecological options

Codes	Reduced flow rates	CEC
B2X-8000-00L-xx-120	1.2 gpm (4.5 l/min) - 60 psi	CEC

B2X-1481-07-xx

B26-1481-07-CD HAÜS-D



CD

2078

B27-1481-07-xx HAÜS-C



CC KK LL BB NN/YY VV/TT GG

1519 1975 2279 2279 1975 2431 3343

B28-1481-07-xx HAÜS-L



CC KK LL BB NN/YY VV/TT GG

1519 1975 2279 2279 1975 2431 3343

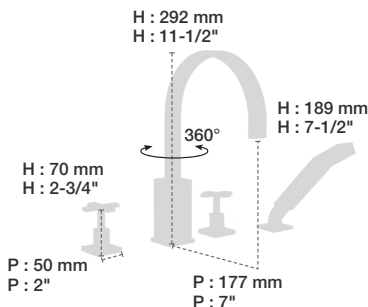

4-piece tub filler with hand shower

Bath spout:

- A- 9 gpm - 60 psi
- B- Cascade-type spout
- C- Swivel spout

Hand shower:

- D- Max: 2 gpm - 80 psi
- E- Non-conductive brass anti-limestone hand shower
- F- DOU-1455-02-xx
- G- CAR-1020-01 (Cold), CAR-1020-02 (Hot)

Ecological options

Codes	Reduced flow rates	CEC
B2X-1481-07-xx-150	1.5 gpm (5.7 l/min) - 80 psi	CEC
B2X-1481-07-xx-175	1.75 gpm (6.6 l/min) - 80 psi	CEC

HAÜS B26 B27 B28

HAÜS
B26 B27 B28

B2X-9404-00-xx

ROUGH & TRIM PACKAGE

B26-9404-00-CD HAÜS-D



CD

1681

B27-9404-00-xx HAÜS-C



CC	KK	LL	BB	NN/YY	VV/TT	GG
1370	1576	1714	1714	1576	1783	2196

B28-9404-00-xx HAÜS-L



CC	KK	LL	BB	NN/YY	VV/TT	GG
1370	1576	1714	1714	1576	1783	2196

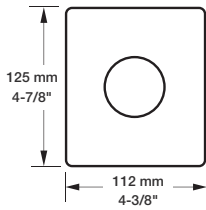

Complete 3/4" thermostatic valve

- A- 16 gpm - 60 psi
- B- Separate volume control or diverter valve required
- C- Can easily supply 3 accessories

- D- Thin brass plate
- E- CAR-3404-00
- F- Rough valve RVA-3404-00-B included
- G- Reversible check / non-return valves in case of water supply inversion



TRIM ONLY

T26-9404-00-CD	HAÜS-D	CD	999
-----------------------	--------	-----------	------------

T27-9404-00-xx / T28-9404-00-xx	HAÜS-C / HAÜS-L	CC	KK	LL	BB	NN/YY	VV/TT	GG
		688	894	1032	1032	894	1101	1514

ROUGH VALVE Please order the following rough valve to complete the trim:

RVA-3404-00-B	Type T rough - 3/4" female NPT connections	682
----------------------	--------------------------------------------	------------

B2X-9560-02-xx

ROUGH & TRIM PACKAGE

B26-9560-02-CD HAÜS-D

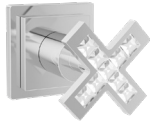

CD

723

B27-9560-02-xx HAÜS-C



CC	KK	LL	BB	NN/YY	VV/TT	GG
586	672	730	730	672	758	930

B28-9560-02-xx HAÜS-L



CC	KK	LL	BB	NN/YY	VV/TT	GG
586	672	730	730	672	758	930

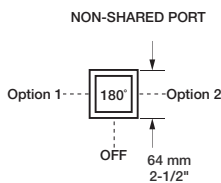
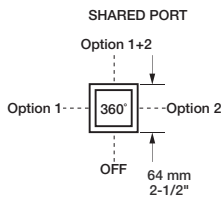

Complete 2-port diverter with off (shared port)

- A- 1 outlet: 10.5 gpm - 60 psi
- A- 2 outlets: 4 gpm - 60 psi
- B- Can replace 2 volume control valves

- C- Up to 2 accessories can be used at the same time
- D- CAR-9525-02
- E- Rough RVA-9562-00-B included
- F- Extra long cartridge for maximum adjustment

Ecological options CEC

Codes	Features
B2X-9560-02-xx-NS	Non-shared port
T2X-9560-02-xx + RVA-9562-00-NS-B	1 accessory works at a time CAR-9525-02-NS (diverter)

TRIM ONLY

T26-9560-02-CD	HAÜS-D	CD	424
-----------------------	--------	-----------	------------

T27-9560-02-xx / T28-9560-02-xx	HAÜS-C / HAÜS-L	CC	KK	LL	BB	NN/YY	VV/TT	GG
		287	373	431	431	373	459	631

ROUGH VALVE Please order the following rough valve to complete the trim:

RVA-9562-00-B	2-port diverter rough - 1/2" male NPT or welded copper connections	299
----------------------	--------------------------------------------------------------------	------------



Finishes:

CC = chrome, KK = matte black, LL = satin brass, BB = white, NN = brushed nickel, YY = polished nickel, TT = venetian bronze, VV = satin copper, GG = gold, CD = chrome diamond

HAÜS B26 B27 B28

B2X-9560-03-xx

ROUGH & TRIM PACKAGE

B26-9560-03-xx HAÜS-D

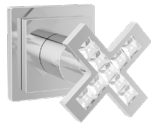

CD

805

B27-9560-03-xx HAÜS-C



CC KK LL BB NN/YY VV/TT GG

668 754 812 812 754 840 1012

B28-9560-03-xx HAÜS-L



CC KK LL BB NN/YY VV/TT GG

668 754 812 812 754 840 1012

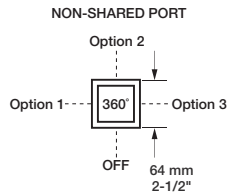
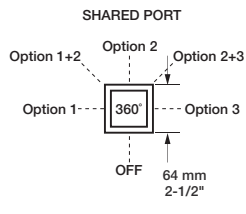

Complete 3-port diverter with off (shared port)

- A- 1 outlet: 9.7 gpm - 60 psi
- A- 2 outlets: 5.2 gpm - 60 psi
- B- Can replace 2 or 3 volume control valves
- C- Up to 2 accessories can be used at the same time
- D- CAR-9530-03
- E- Rough RVA-9563-00-B included
- F- Extra long cartridge for maximum adjustment

Ecological options CEC

Codes	Features
B2X-9560-03-xx-NS	Non-shared port
T2X-9560-03-xx + RVA-9563-00-NS-B	1 accessory works at a time CAR-9530-03-NS (diverter)

TRIM ONLY

T26-9560-03-CD	HAÜS-D	CD
		424

T27-9560-03-xx / T28-9560-03-xx	HAÜS-C / HAÜS-L	CC	KK	LL	BB	NN/YY	VV/TT	GG
		287	373	431	431	373	459	631

ROUGH VALVE Please order the following rough valve to complete the trim:

RVA-9563-00-B	3-port diverter rough - inlet: 3/4" F NPT - outlets: 1/2" F NPT	381
----------------------	-----------------------------------------------------------------	------------

B2X-9600-00-xx

ROUGH & TRIM PACKAGE

B26-9600-00-CD HAÜS-D



CD

598

B27-9600-00-xx HAÜS-C



CC KK LL BB NN/YY VV/TT GG

461 547 605 605 547 633 805

B28-9600-00-xx HAÜS-L



CC KK LL BB NN/YY VV/TT GG

461 547 605 605 547 633 805

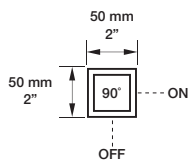

Complete 1/2" volume control valve

- A- 7.9 gpm - 60 psi
- B- Volume control valve
- C- CAR-1011-81
- D- Rough valve RVA-2020-01-B included
- E- Extra long cartridge for maximum adjustment

TRIM ONLY

T26-9600-00-xx	HAÜS-D	CD
		424

T27-9600-00-xx / T28-9600-00-xx	HAÜS-C / HAÜS-L	CC	KK	LL	BB	NN/YY	VV/TT	GG
		287	373	431	431	373	459	631

ROUGH VALVE Please order the following rough valve to complete the trim:

RVA-2020-01-B	Volume control valve rough - 1/2" female NPT connections	174
----------------------	----------------------------------------------------------	------------

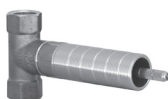

Actual products may differ from pictures. Actual products measures may differ from the measures shown. All CAD prices are subject to change without notice. Effective as of June 2023.

HAÜS B26 B27 B28

B2X-9640-00-xx

ROUGH & TRIM PACKAGE

B26-9640-00-CD HAÜS-D

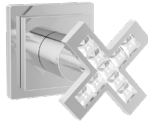

CD

659

B27-9640-00-xx HAÜS-C



CC KK LL BB NN/YY VV/TT GG

522 608 666 666 608 694 866

B28-9640-00-xx HAÜS-L



CC KK LL BB NN/YY VV/TT GG

522 608 666 666 608 694 866

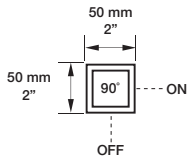

Complete 3/4" volume control valve

- A- 11.1 gpm - 60 psi
- B- Volume control valve
- C- Offers higher flow
- D- CAR-2719-34
- E- Rough valve RVA-2719-34-B included
- F- Extra long cartridge for maximum adjustment

TRIM ONLY

T26-9640-00-CD HAÜS-D

CD
424

T27-9640-00-xx / T28-9640-00-xx HAÜS-C / HAÜS-L

CC	KK	LL	BB	NN/YY	VV/TT	GG
287	373	431	431	373	459	631



ROUGH VALVE Please order the following rough valve to complete the trim:

RVA-2719-34-B

Volume control valve rough - 3/4" female NPT connections

235

HAÜS
B26 B27 B28

Finishes:

CC = chrome, KK = matte black, LL = satin brass, BB = white, NN = brushed nickel, YY = polished nickel, TT = venetian bronze, VV = satin copper, GG = gold, CD = chrome diamond

HAÜS B26 B27 B28

SELECTION OF SHOWER COMPONENTS

For more shower components and for ecological options, please refer to the shower components section (see p. 347-382).

TET-0811-02-xx 8" square shower head  <table border="1"> <thead> <tr> <th>CC</th> <th>KK</th> <th>LL</th> <th>BB</th> </tr> </thead> <tbody> <tr> <td>460</td> <td>598</td> <td>690</td> <td>690</td> </tr> </tbody> </table>	CC	KK	LL	BB	460	598	690	690	TET-1011-01-xx 10" square shower head  <table border="1"> <thead> <tr> <th>CC</th> <th>KK</th> <th>LL</th> <th>BB</th> </tr> </thead> <tbody> <tr> <td>630</td> <td>819</td> <td>945</td> <td>945</td> </tr> </tbody> </table>	CC	KK	LL	BB	630	819	945	945	TET-1212-04-xx 12" square shower head  <table border="1"> <thead> <tr> <th>CC</th> <th>KK</th> <th>LL</th> <th>BB</th> </tr> </thead> <tbody> <tr> <td>825</td> <td>1073</td> <td>1238</td> <td>1238</td> </tr> </tbody> </table>	CC	KK	LL	BB	825	1073	1238	1238	TET-1616-02-xx 16" square shower head  <table border="1"> <thead> <tr> <th>CC</th> <th>KK</th> <th>LL</th> <th>BB</th> </tr> </thead> <tbody> <tr> <td>1295</td> <td>1684</td> <td>1943</td> <td>1943</td> </tr> </tbody> </table>	CC	KK	LL	BB	1295	1684	1943	1943	BRA-1612-44-xx 16" shower arm  <table border="1"> <thead> <tr> <th>CC</th> <th>KK</th> <th>LL</th> <th>BB</th> </tr> </thead> <tbody> <tr> <td>199</td> <td>259</td> <td>299</td> <td>299</td> </tr> </tbody> </table>	CC	KK	LL	BB	199	259	299	299
CC	KK	LL	BB																																									
460	598	690	690																																									
CC	KK	LL	BB																																									
630	819	945	945																																									
CC	KK	LL	BB																																									
825	1073	1238	1238																																									
CC	KK	LL	BB																																									
1295	1684	1943	1943																																									
CC	KK	LL	BB																																									
199	259	299	299																																									
TET-0814-01-xx 8" square shower head  <table border="1"> <thead> <tr> <th>CC</th> </tr> </thead> <tbody> <tr> <td>330</td> </tr> </tbody> </table>	CC	330	TET-1014-01-xx 10" square shower head  <table border="1"> <thead> <tr> <th>CC</th> </tr> </thead> <tbody> <tr> <td>439</td> </tr> </tbody> </table>	CC	439	TET-1214-01-xx 12" square shower head  <table border="1"> <thead> <tr> <th>CC</th> </tr> </thead> <tbody> <tr> <td>595</td> </tr> </tbody> </table>	CC	595	TET-1614-01-xx 16" square shower head  <table border="1"> <thead> <tr> <th>CC</th> </tr> </thead> <tbody> <tr> <td>832</td> </tr> </tbody> </table>	CC	832	BRA-1812-14-xx 18" shower arm  <table border="1"> <thead> <tr> <th>CC</th> <th>KK</th> <th>LL</th> <th>BB</th> </tr> </thead> <tbody> <tr> <td>188</td> <td>244</td> <td>282</td> <td>282</td> </tr> </tbody> </table>	CC	KK	LL	BB	188	244	282	282																								
CC																																												
330																																												
CC																																												
439																																												
CC																																												
595																																												
CC																																												
832																																												
CC	KK	LL	BB																																									
188	244	282	282																																									
DGL-1670-03-xx 3-spray sliding shower bar  <table border="1"> <thead> <tr> <th>CC</th> <th>KK</th> <th>LL</th> <th>BB</th> </tr> </thead> <tbody> <tr> <td>694</td> <td>902</td> <td>1041</td> <td>1041</td> </tr> </tbody> </table>	CC	KK	LL	BB	694	902	1041	1041	DGL-3070-53-xx 3-spray sliding shower bar  <table border="1"> <thead> <tr> <th>CC</th> <th>KK</th> <th>LL</th> <th>BB</th> </tr> </thead> <tbody> <tr> <td>629</td> <td>818</td> <td>944</td> <td>944</td> </tr> </tbody> </table>	CC	KK	LL	BB	629	818	944	944	DGL-4880-03-xx 3-spray sliding shower bar  <table border="1"> <thead> <tr> <th>CC</th> <th>KK</th> <th>LL</th> <th>BB</th> </tr> </thead> <tbody> <tr> <td>849</td> <td>1104</td> <td>1274</td> <td>1274</td> </tr> </tbody> </table>	CC	KK	LL	BB	849	1104	1274	1274	DSP-2555-20-xx Hand shower on wall-mounted supply elbow  <table border="1"> <thead> <tr> <th>CC</th> <th>KK</th> <th>LL</th> <th>BB</th> </tr> </thead> <tbody> <tr> <td>436</td> <td>567</td> <td>654</td> <td>654</td> </tr> </tbody> </table>	CC	KK	LL	BB	436	567	654	654	RAC-9001-18-xx 1/2"F wall-mount supply elbow  <table border="1"> <thead> <tr> <th>CC</th> <th>KK</th> <th>LL</th> <th>BB</th> </tr> </thead> <tbody> <tr> <td>144</td> <td>187</td> <td>216</td> <td>216</td> </tr> </tbody> </table>	CC	KK	LL	BB	144	187	216	216
CC	KK	LL	BB																																									
694	902	1041	1041																																									
CC	KK	LL	BB																																									
629	818	944	944																																									
CC	KK	LL	BB																																									
849	1104	1274	1274																																									
CC	KK	LL	BB																																									
436	567	654	654																																									
CC	KK	LL	BB																																									
144	187	216	216																																									
BEC-0520-22-xx Cascade-type tub spout without diverter  <table border="1"> <thead> <tr> <th>CC</th> <th>KK</th> <th>LL</th> <th>BB</th> </tr> </thead> <tbody> <tr> <td>312</td> <td>406</td> <td>468</td> <td>468</td> </tr> </tbody> </table>	CC	KK	LL	BB	312	406	468	468	BEC-0520-39-xx Square modern tub spout without diverter  <table border="1"> <thead> <tr> <th>CC</th> <th>KK</th> <th>LL</th> <th>BB</th> </tr> </thead> <tbody> <tr> <td>359</td> <td>467</td> <td>539</td> <td>539</td> </tr> </tbody> </table>	CC	KK	LL	BB	359	467	539	539	BOD-5004-02-xx Square lateral body jet  <table border="1"> <thead> <tr> <th>CC</th> <th>KK</th> <th>LL</th> <th>BB</th> </tr> </thead> <tbody> <tr> <td>248</td> <td>322</td> <td>372</td> <td>372</td> </tr> </tbody> </table>	CC	KK	LL	BB	248	322	372	372	BOD-5006-01-xx Square built-in lateral body jet  <table border="1"> <thead> <tr> <th>CC</th> <th>KK</th> <th>LL</th> <th>BB</th> </tr> </thead> <tbody> <tr> <td>350</td> <td>455</td> <td>525</td> <td>525</td> </tr> </tbody> </table>	CC	KK	LL	BB	350	455	525	525	RAC-9402-14-xx 1/2"F wall-mount supply elbow with integrated volume control  <table border="1"> <thead> <tr> <th>CC</th> <th>KK</th> <th>LL</th> <th>BB</th> </tr> </thead> <tbody> <tr> <td>224</td> <td>291</td> <td>336</td> <td>336</td> </tr> </tbody> </table>	CC	KK	LL	BB	224	291	336	336
CC	KK	LL	BB																																									
312	406	468	468																																									
CC	KK	LL	BB																																									
359	467	539	539																																									
CC	KK	LL	BB																																									
248	322	372	372																																									
CC	KK	LL	BB																																									
350	455	525	525																																									
CC	KK	LL	BB																																									
224	291	336	336																																									

Actual products may differ from pictures. Actual products measures may differ from the measures shown. All USD prices are subject to change without notice. Effective as of August 2023.

HAÜS B26 B27 B28

COMPLETE SHOWER KITS

PRO-1401-03-xx



Complete thermostatic shower kit on square column

CC	KK	LL	BB	NN/YY	VV/TT	GG
2245	2919	3368	3368	2919	3592	4939

Features

- A- Max: 2 gpm - 80 psi (per accessory)
- B- 3-spray hand shower
- C- 2 accessories can work together
- D- Temperature handle on the hot water inlet side, allowing the surface temperature to never exceed the shower water temperature
- E- Shower head arm adjustable up to 20" in height
- F- Thermostatic cartridge: CAR-2661-00
- G- Diverter cartridge: CAR-3003-36

Ecological options CEC

Code	Features are the same, except:
PRO-1401-03-xx-NS	A- Max: 1.75 gpm - 80 psi (per accessory) C- 1 accessory works at a time G- Diverter cartridge: CAR-3003-36-NS

PRO-3420-26-CD

PRR-3420-26-CD*

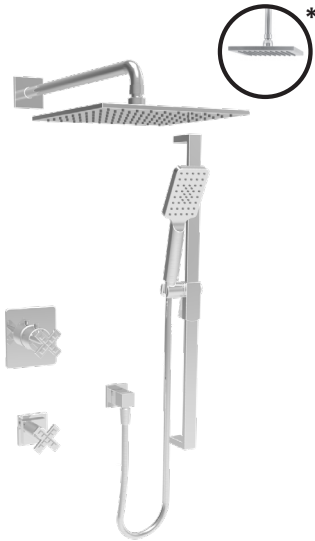

Complete thermostatic shower kit

CD
3795

Features

- A- 2 accessories kit
- B- Max: 2 gpm - 80 psi (per accessory)
- C- 3-spray hand shower
- D- 2 accessories can work together

Includes

- B26-9404-00-CD** Complete 3/4" thermostatic valve
- B26-9560-02-CD** Complete 2-port diverter with off
- TET-1011-01-xx** 10" square shower head
- BRA-1812-14-xx** 18" shower arm
- DGL-3070-53-xx** 3-spray sliding shower bar
- RAC-9001-18-xx** Wall-mount supply elbow

Ecological options CEC

Codes	Features are the same, except:
PRO-3420-26-CD-NS	B- Max: 1.75 gpm - 80 psi (per accessory) D- 1 accessory works at a time
TRO-3420-26-CD-NS + RVA-3404-00-B +	
RVA-9562-00-NS-B	

TRIM ONLY

TRO-3420-26-CD
TRR-3420-26-CD*

CD
2814

ROUGH VALVES Please order all of the following rough valves to complete the trim:

RVA-3404-00-B

Type T rough - 3/4" female NPT connections

682

RVA-9562-00-B

2-port diverter rough - 1/2" male NPT or welded copper connections

299

Finishes:

CC = chrome, KK = matte black, LL = satin brass, BB = white, NN = brushed nickel, YY = polished nickel, TT = venetian bronze, VV = satin copper, GG = gold, CD = chrome diamond

* With 6" ceiling mount shower arm

HAÜS B26 B27 B28

PRO-3420-27-xx PRR-3420-27-xx*

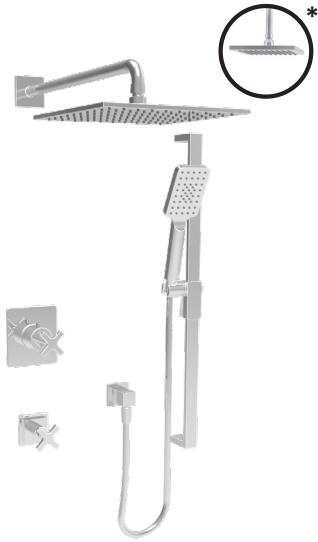

Complete thermostatic shower kit

CC	KK	LL	BB	NN/YY	VV/TT	GG
2920	3796	4380	4380	3796	4672	6424

Features

- A- 2 accessories kit
- B- Max: 2 gpm - 80 psi (per accessory)
- C- 3-spray hand shower
- D- 2 accessories can work together

Includes

- B27-9404-00-xx** Complete 3/4" thermostatic valve
- B27-9560-02-xx** Complete 2-port diverter with off
- TET-1011-01-xx** 10" square shower head
- BRA-1812-14-xx** 18" shower arm
- DGL-3070-53-xx** 3-spray sliding shower bar
- RAC-9001-18-xx** Wall-mount supply elbow

Ecological options CEC

Codes

PRO-3420-27-xx-NS
TRO-3420-27-xx-NS + RVA-3404-00-B +
RVA-9562-00-NS-B

Features are the same, except:

- B- Max: 1.75 gpm - 80 psi (per accessory)
- D- 1 accessory works at a time

TRIM ONLY

TRO-3420-27-xx TRR-3420-27-xx*

CC	KK	LL	BB	NN/YY	VV/TT	GG
1939	2815	3399	3399	2815	3691	5443

ROUGH VALVES Please order **all** of the following rough valves to complete the trim:

RVA-3404-00-B	Type T rough - 3/4" female NPT connections	682
----------------------	--------------------------------------------	------------

RVA-9562-00-B	2-port diverter rough - 1/2" male NPT or welded copper connections	299
----------------------	--------------------------------------------------------------------	------------

PRO-3420-28-xx PRR-3420-28-xx*

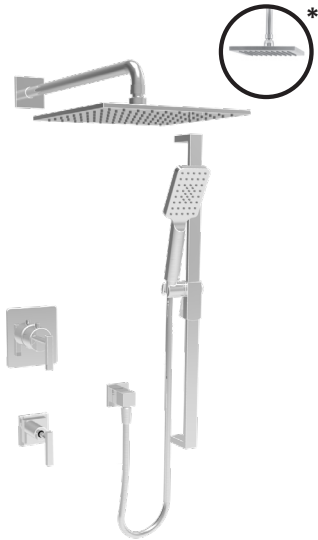

Complete thermostatic shower kit

CC	KK	LL	BB	NN/YY	VV/TT	GG
2920	3796	4380	4380	3796	4672	6424

Features

- A- 2 accessories kit
- B- Max: 2 gpm - 80 psi (per accessory)
- C- 3-spray hand shower
- D- 2 accessories can work together

Includes

- B28-9404-00-xx** Complete 3/4" thermostatic valve
- B28-9560-02-xx** Complete 2-port diverter with off
- TET-1011-01-xx** 10" square shower head
- BRA-1812-14-xx** 18" shower arm
- DGL-3070-53-xx** 3-spray sliding shower bar
- RAC-9001-18-xx** Wall-mount supply elbow

Ecological options CEC

Codes

PRO-3420-28-xx-NS
TRO-3420-28-xx-NS + RVA-3404-00-B +
RVA-9562-00-NS-B

Features are the same, except:

- B- Max: 1.75 gpm - 80 psi (per accessory)
- D- 1 accessory works at a time

TRIM ONLY

TRO-3420-28-xx TRR-3420-28-xx*

CC	KK	LL	BB	NN/YY	VV/TT	GG
1939	2815	3399	3399	2815	3691	5443

ROUGH VALVES Please order **all** of the following rough valves to complete the trim:

RVA-3404-00-B	Type T rough - 3/4" female NPT connections	682
----------------------	--------------------------------------------	------------

RVA-9562-00-B	2-port diverter rough - 1/2" male NPT or welded copper connections	299
----------------------	--------------------------------------------------------------------	------------

Actual products may differ from pictures. Actual products measures may differ from the measures shown. All USD prices are subject to change without notice. Effective as of August 2023.

HAÜS B26 B27 B28

SELECTION OF BATHROOM ACCESSORIES

For more bathroom accessories, please refer to the bathroom accessories section (see p. 293-306).

A44-1029-00-xx

FLAT
Square wall-mounted toilet paper holder



CC	KK	LL	BB	NN/YY	VV/TT	GG
144	187	216	216	187	230	317

A44-1069-00-xx

FLAT
Square bathrobe holder



CC	KK	LL	BB	NN/YY	VV/TT	GG
90	117	135	135	117	144	198

A44-6017-00-xx

FLAT
25" square single towel bar



CC	KK	LL	BB	NN/YY	VV/TT	GG
248	323	372	372	323	397	546

A44-6027-00-xx

FLAT
Square double towel bar



CC	KK	LL	BB	NN/YY	VV/TT	GG
298	387	447	447	387	477	656

A85-2009-40-xx

Towel holder on stand



CC
523

HAÜS
B26 B27 B28

Finishes:

CC = chrome, KK = matte black, LL = satin brass, BB = white, NN = brushed nickel, YY = polished nickel, TT = venetian bronze, VV = satin copper, GG = gold, CD = chrome diamond

MARIE B35

Compatible with the Touchless Sensor
Order ELE-2001-01-xx (p. 43)

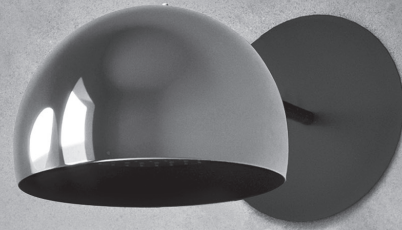

BARIL

MARIE B35

LEGEND

Finishes

The MARIE collection has 6 finishes.

C = chrome I = mist
E = glossy black J = french gold
H = blush K = matte black

The choice of finishes must be made for each component of the faucet according to the legend.

Price

Lavatory Faucet:

The price is determined by the spout finish.

Shower/bath Valve:

The price is determined by the wall plate finish.

B35-8009-00L-xxxx

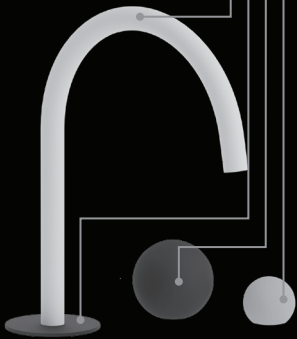

To Order

The 4 letters of finishes must be replaced by the desired finishes for each of the components.

The order of the components is indicated in the image as well as in the features.

For example, the faucet above includes:

- Spout in mist finish (I)
- Flange in matte black finish (K)
- Handle 1 (large, flow rate) in matte black finish (K)
- Handle 2 (small, temperature) in mist finish (I)

The product code is therefore: B35-8009-00L-IKKI

Spout - Chrome

1405

Spout - Other finishes

1622

Two-handle deck-mounted lavatory faucet, drain not included

- A- Max: 1.5 gpm (5,7 l/min) - 60 psi
- B- Laminar stream
- C- Order your lavatory drain in chrome, matte black, mist or french gold finish (pages 309-310)
- D- Optional under handle flange: order ROS-4717-03-xx
- E- CAR-1020-01 (volume control)
CAR-0KDN-28 (temperature control)

Choose your finishes

- 1st x: Spout** Chrome (C), mist (I), french gold (J), matte black (K)
- 2nd x: Flange** Chrome (C), glossy black (E), blush (H), mist (I), french gold (J), matte black (K)
- 3rd x: Handle 1** Chrome (C), glossy black (E), mist (I), french gold (J), matte black (K)
- 4th x: Handle 2** Chrome (C), glossy black (E), blush (H), mist (I), french gold (J), matte black (K)

Ecological options

Codes	Reduced flow rates	CEC
B35-8009-00L-xxxx-120	1.2 gpm (4.5 l/min) - 60 psi	CEC
B35-8009-00L-xxxx-100	1.0 gpm (3.7 l/min) - 60 psi	
B35-8009-00L-xxxx-050	0.5 gpm (1.9 l/min) - 60 psi	

B35-1020-00L-xKx

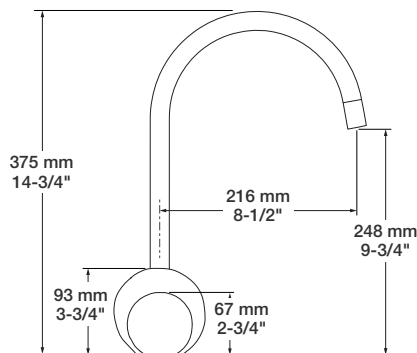

Spout - Chrome

1297

Spout - Other finishes

1514

Single handle vessel lavatory faucet, drain not included

- A- Max: 1.5 gpm (5,7 l/min) - 60 psi
- B- Laminar stream
- C- Order your lavatory drain in chrome, matte black, mist or french gold finish (pages 309-310)
- D- CAR-0KRB-28 (progressive)
- E- Optional under handle flange; order ROS-4717-03-xx

Choose your finishes

- 1st x: Spout** Chrome (C), mist (I), french gold (J), matte black (K)
- 2nd x: Flange** Matte black (K)
- 3rd x: Handle** Glossy black (E), mist (I), french gold (J), matte black (K)

Ecological options

Codes	Reduced flow rates	CEC
B35-1020-00L-xKx-120	1.2 gpm (4.5 l/min) - 60 psi	CEC
B35-1020-00L-xKx-100	1.0 gpm (3.7 l/min) - 60 psi	
B35-1020-00L-xKx-050	0.5 gpm (1.9 l/min) - 60 psi	

MARIE B35

B35-8009-00L-xxxx

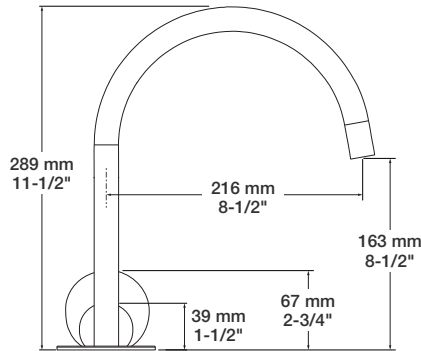

Spout - Chrome

Spout - Other finishes

1405

1622

Two-handle deck-mounted lavatory faucet, drain not included

- A- Max: 1.5 gpm (5,7 l/min) - 60 psi
- B- Laminar stream
- C- Order your lavatory drain in chrome, matte black, mist or french gold finish (pages 309-310)
- D- Optional under handle flange: order ROS-4717-03-xx
- E- CAR-1020-01 (volume control)
CAR-0KDN-28 (temperature control)

Choose your finishes

- 1st x: Spout** Chrome (C), mist (I), french gold (J), matte black (K)
- 2nd x: Flange** Chrome (C), glossy black (E), blush (H), mist (I), french gold (J), matte black (K)
- 3rd x: Handle 1** Chrome (C), glossy black (E), mist (I), french gold (J), matte black (K)
- 4th x: Handle 2** Chrome (C), glossy black (E), blush (H), mist (I), french gold (J), matte black (K)

Ecological options

Codes	Reduced flow rates	
B35-8009-00L-xxxx-120	1.2 gpm (4,5 l/min) - 60 psi	CEC
B35-8009-00L-xxxx-100	1.0 gpm (3,7 l/min) - 60 psi	
B35-8009-00L-xxxx-050	0.5 gpm (1,9 l/min) - 60 psi	

MARIE B35

B35-8100-00L-xxxx

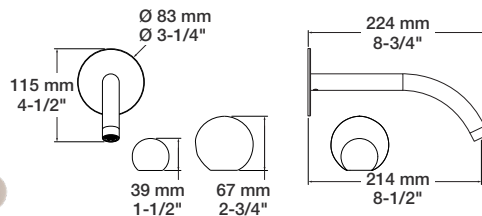
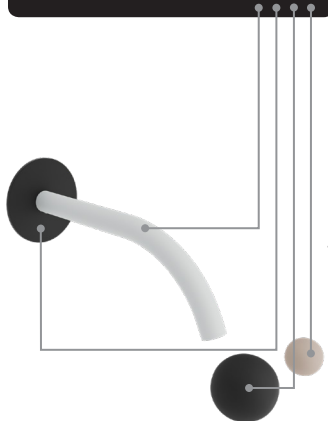

Spout - Chrome

Spout - Other finishes

1405

1622

Wall-mounted lavatory faucet spout with deck-mounted handles, drain not included

- A- Max: 1.5 gpm (5,7 l/min) - 60 psi
- B- 2 choices of aerator included: non-adjustable laminar or adjustable aerated
- C- Order your lavatory drain in chrome, matte black, mist or french gold finish (pages 309-310)
- D- Optional under handle flange: order ROS-4717-03-xx
- E- CAR-1020-01 (volume control)
CAR-0KDN-28 (temperature control)

Choose your finishes

- 1st x: Spout** Chrome (C), mist (I), french gold (J), matte black (K)
- 2nd x: Flange** Chrome (C), glossy black (E), blush (H), mist (I), french gold (J), matte black (K)
- 3rd x: Handle 1** Chrome (C), glossy black (E), mist (I), french gold (J), matte black (K)
- 4th x: Handle 2** Chrome (C), glossy black (E), blush (H), mist (I), french gold (J), matte black (K)

Ecological options

Codes	Reduced flow rates	
B35-8100-00L-xxxx-120	1.2 gpm (4,5 l/min) - 60 psi	CEC
B35-8100-00L-xxxx-100	1.0 gpm (3,7 l/min) - 60 psi	
B35-8100-00L-xxxx-050	0.5 gpm (1,9 l/min) - 60 psi	

ROS-4717-03-xx

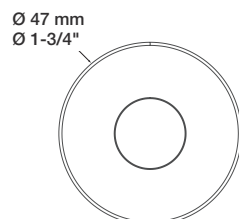
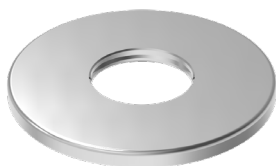

CC - Chrome

KK - Matte Black

27

35

Oversized under handle flange Ø 1-3/4" (47 mm)

- A- 1-3/4" outer diameter cover plate
- B- Required for installation over pre-drilled sinks or to cover countertop gaps, holes and damage

Finishes:

C = chrome, E= glossy black, H= blush, I= mist, J= french gold, K= matte black. For more details, please refer to page 128.

MARIE B35

B35-1100-00-KE



KE

1545

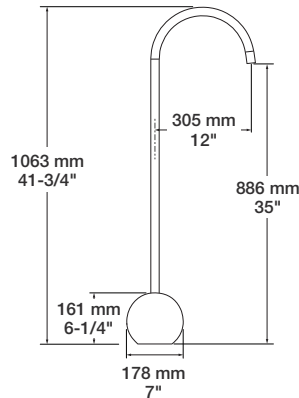
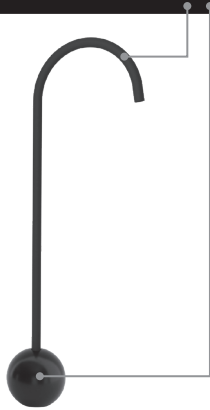

Floor-mounted tub spout

- A- This tub spout is a freestanding piece that does not include a control valve
- B- To control the water flow and temperature, it must be combined with a bath/shower valve without a spout

Finishes

- 1st letter: Spout** Matte black (K)
- 2nd letter: Flange** Glossy black (E)

OPTION 1

FLOOR-MOUNTED TUB SPOUT + COMPLETE THERMOSTATIC VALVE WITH 2-WAY DIVERTER (HAND SHOWER + SPOUT)



Floor-mounted tub spout + complete thermostatic valve with 2-way diverter (hand shower + spout)

- A- Spout code: B35-1100-00-KE
- B- Valve code: B35-9320-00-xxx
- C- For more details on the features and finishes of the tub spout or the valve, refer to their respective codes
- D- Total price: \$5880

FLOOR-MOUNTED TUB SPOUT

B35-1100-00-KE

KE

1545

COMPLETE THERMOSTATIC VALVE WITH 2-WAY DIVERTER

B35-9320-00-xxx

All finishes

4335

OPTION 2

FLOOR-MOUNTED TUB SPOUT + COMPLETE THERMOSTATIC SHOWER CONTROL VALVE WITH 2-WAY DIVERTER + HAND SHOWER ON WALL-MOUNTED HOLDER WITH SUPPLY ELBOW



Floor-mounted tub spout + complete thermostatic valve with 2-way diverter + hand shower on wall-mounted holder with supply elbow

- A- Spout code: B35-1100-00-KE
- B- Valve code: B35-9521-00-xx
- C- Hand shower code: RAC-9001-35-xx
- D- For more details on the features and finishes of the tub spout, valve or hand shower, refer to their respective codes
- E- Total: Plate (chrome): \$4371
Plate (other finishes): \$4588

FLOOR-MOUNTED TUB FILLER

B35-1100-00-KE

KE

1545

COMPLETE THERMOSTATIC SHOWER CONTROL VALVE WITH 2-WAY DIVERTER

B35-9521-00-xx

Plate - Chrome

1731

Plate - Other finishes

1948

HAND SHOWER ON WALL-MOUNTED HOLDER WITH SUPPLY ELBOW

RAC-9001-35-xx

KK - Matte Black

1095

II - Mist

1095

MARIE B35

B35-9320-00-xxx

ROUGH & TRIM PACKAGE

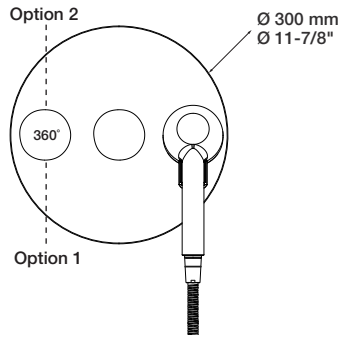
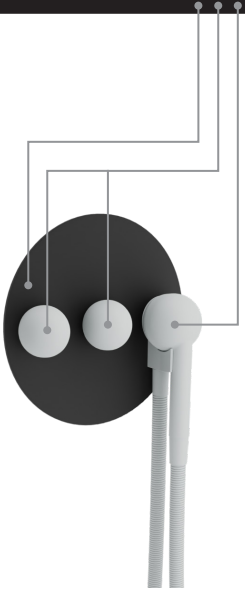

All finishes

4335

Complete thermostatic valve with 2-way diverter (hand shower + tub spout or shower head)

- A- 8 gpm (30 l/min) - 60 psi
- B- Easy to install one-piece rough
- C- Solid brass plate
- D- CAR-3404-00 (temperature), CAR-9530-03 (diverter)
- E- Rough valve included
- F- Reversible check / non-return valves in case of water supply inversion

Hand shower:

- G- Max: 2 gpm (7,6l/min) - 80 psi
- H- 2 positions shower holder
- I- Hand shower DOU-2635-02-xx with 59" brass hose

Choose your finishes

- 1st x: Plate** Mist (I), matte black (K)
- 2nd x: Handles** Mist (I), french gold (J), matte black (K)
- 3rd x: Hand shower** Mist (I), matte black (K)

Ecological option

Code	Reduced flow rate	CEC
B35-9320-00-xx-175	6.6 l/min (1.75 gpm) - 80 psi	

TRIM ONLY

T35-9320-00-xx

All finishes

2610

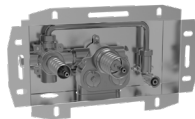

ROUGH VALVE Please order the following rough valve to complete the trim:

RVA-34B2-00-B

Type T rough with 2-way diverter - inlet: 3/4" F NPT - outlets: 1/2" F NPT

1725

B35-9521-00-xx

ROUGH & TRIM PACKAGE

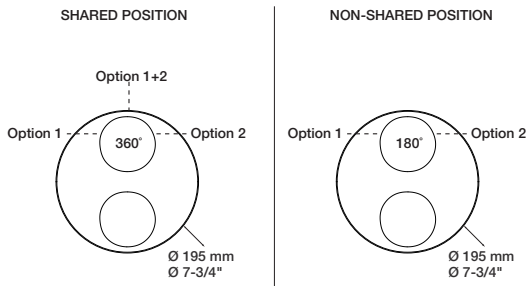
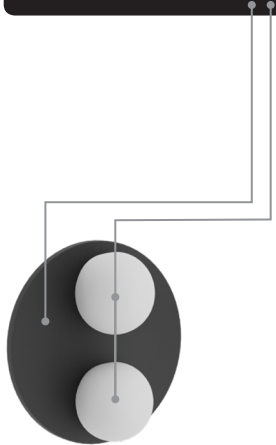

Plate - Chrome

1731

Plate - Other finishes

1948

Complete thermostatic pressure balanced shower control valve with 2-way diverter (shared ports)

- A- 1 outlet: 7.9 gpm - 60 psi, 2 outlets: 3.7 gpm - 60 psi
- B- Up to 2 accessories can be used at the same time
- C- Reversible check / non-return valves in case of water supply inversion
- D- CAR-2661-00 (temperature), CAR-3003-36 (diverter)
- E- Rough valve RVA-9521-00-B included
- F- Large depth adjustment range

Choose your finishes

- 1st x: Plate** Chrome (C), mist (I), matte black (K)
- 2nd x: Handles** Mist (I), french gold (J), matte black (K)

Ecological options

Codes	Features
B35-9521-00-xx-NS	Non-shared ports
T35-9521-00-xx + RVA-9521-00-NS-B	1 accessory works at a time
T35-9521-00-xx + RVA-9521-PO-NS-B	CAR-3003-36-NS (diverter)

TRIM ONLY

T35-9521-00-xx

Plate - Chrome

1046

Plate - Other finishes

1263

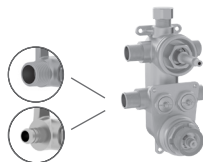

ROUGH VALVES Please order **one** of the following rough valves to complete the trim:

RVA-9521-00-B

2-way type T rough - 1/2" male NPT or welded copper connections

685

RVA-9521-PO-B

2-way type T rough - PEX connections

685

Finishes:

C = chrome, E = glossy black, H = blush, I = mist, J = french gold, K = matte black. For more details, please refer to page 128.

MARIE B35

MARIE B35

OPTION 1

SHOWER HEAD + COMPLETE THERMOSTATIC VALVE WITH 2-WAY DIVERTER (HAND SHOWER + SHOWER HEAD)



Shower head + complete thermostatic valve with 2-way diverter (hand shower + shower head)

- A- Shower head code: TET-1210-35-xxx
- B- Valve code: B35-9320-00-xxx
- C- For more details on the features and finishes of the shower head or the valve, refer to their respective codes
- D- Total price: \$6080

12" ANTI-LIMESTONE SHOWER HEAD WITH WALL-MOUNTED SHOWER ARM

TET-1210-35-xxx

All finishes

1745

COMPLETE THERMOSTATIC VALVE WITH 2-WAY DIVERTER

B35-9320-00-xxx

All finishes

4335



OPTION 2

SHOWER HEAD + COMPLETE THERMOSTATIC PRESSURE BALANCED VALVE WITH 2-WAY DIVERTER + HAND SHOWER ON WALL-MOUNTED HOLDER WITH SUPPLY ELBOW



Shower head + complete thermostatic pressure balanced valve with 2-way diverter + hand shower on wall-mounted holder with supply elbow

- A- Shower head code: TET-1210-35-xxx
- B- Valve code: B35-9521-00-xx
- C- Hand shower code: RAC-9001-35-xx
- D- For more details on the features and finishes of the shower head, valve or hand shower, refer to their respective codes
- E- Total price: Plate (chrome): \$4571
Plate (other finishes): \$4788

12" ANTI-LIMESTONE SHOWER HEAD WITH WALL-MOUNTED SHOWER ARM

TET-1210-35-xxx

All finishes

1745

COMPLETE THERMOSTATIC PRESSURE BALANCED VALVE WITH 2-WAY DIVERTER

B35-9521-00-xx

Plate - Chrome

1731

Plate - Other finishes

1948

HAND SHOWER ON WALL-MOUNTED HOLDER WITH SUPPLY ELBOW

RAC-9001-35-xx

KK - Matte Black

1095

II - Mist

1095



Actual products may differ from pictures. Actual products measures may differ from the measures shown. All USD prices are subject to change without notice. Effective as of August 2023.

MARIE B35

TET-1210-35-xxx



All finishes

1745

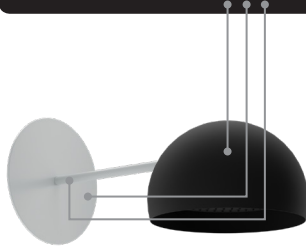

Ø 300 mm

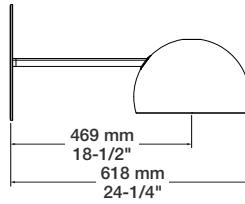
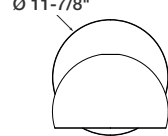

12" anti-limestone shower head with wall-mounted shower arm

- A- 2 gpm (7.6 l/min) - 80 psi
- B- Black stainless steel head
- C- Install only with included wall mount straight shower arm

Choose your finishes

- 1st x: Head** Mist (I), french gold (J), matte black (K)
- 2nd x: Flange** Mist (I), matte black (K)
- 3rd x: Arm** Mist (I), matte black (K)

Ecological option

Code	Reduced flow rates
TET-1210-35-xxx-175	6.6 l/min (1.75 gpm) - 80 psi CEC

RAC-9001-35-xx



KK - Matte Black

II - Mist

1095

1095

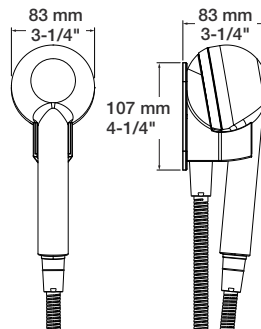

Hand shower on wall-mounted holder with supply elbow

- A- 2-spray anti-limestone hand shower
- B- 2-spray mechanism: rain, massage
- C- Easy-to-clean silicone nozzles
- D- 2 gpm (7.6 l/min) - 80 psi
- E- 59" (150 cm) double interlock brass flexible hose, rotating nut with 2 non-return valves

Ecological option

Code	Reduced flow rates
RAC-9001-35-xx-175	6.6 l/min (1.75 gpm) - 80 psi CEC

MARIE B35

Finishes:

C = chrome, E= glossy black, H= blush, I= mist, J= french gold, K= matte black. For more details, please refer to page 128.

SENS B45

Compatible with the Touchless Sensor
Order ELE-2001-01-xx (p. 43)



BARIL

SENS B45

B45-1005-1PL-xx

DRAIN INCLUDED  

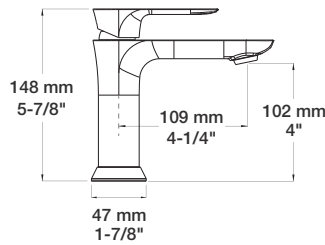

DRAIN NOT INCLUDED

B45-1005-00L-xx

D- Order your lavatory drain (pages 309-310)

CC	KK	LL	BB	NN/YY	VV/TT	GG
544	707	815	815	707	870	1196

Single-hole lavatory faucet, drain included

- A- Max: 1.5 gpm - 60 psi
- B- Easy-to-clean adjustable silicone aerator
- C- CAR-1025-08
- D- Push-button drain with overflow included

Ecological options

Codes	Reduced flow rates	CEC
B45-1005-XXL-xx-120	1.2 gpm (4.5 l/min) - 60 psi	
B45-1005-XXL-xx-100	1.0 gpm (3.7 l/min) - 60 psi	
B45-1005-XXL-xx-050	0.5 gpm (1.9 l/min) - 60 psi	

CC	KK	LL	BB	NN/YY	VV/TT	GG
496	644	743	743	644	793	1085

THE ESSENTIALS

B45-1010-1PL-xx

DRAIN INCLUDED   

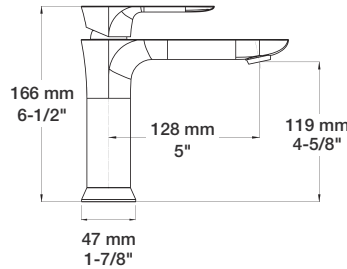

DRAIN NOT INCLUDED

B45-1010-00L-xx

D- Order your lavatory drain (pages 309-310)

CC	KK	LL	BB	NN/YY	VV/TT	GG
578	751	867	867	751	924	1271

Single-hole lavatory faucet, drain included

- A- Max: 1.5 gpm - 60 psi
- B- Easy-to-clean adjustable silicone aerator
- C- CAR-1025-09
- D- Push-button drain with overflow included

Ecological options

Codes	Reduced flow rates	CEC
B45-1010-XXL-xx-120	1.2 gpm (4.5 l/min) - 60 psi	
B45-1010-XXL-xx-100	1.0 gpm (3.7 l/min) - 60 psi	
B45-1010-XXL-xx-050	0.5 gpm (1.9 l/min) - 60 psi	

CC	KK	LL	BB	NN/YY	VV/TT	GG
530	688	795	795	688	847	1160

B45-1020-00L-xx

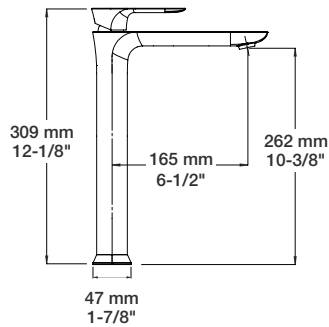

B45-8009-00L-xx

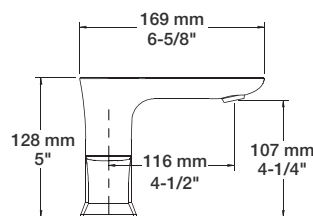

CC	KK	LL	BB	NN/YY	VV/TT	GG
734	954	1101	1101	954	1174	1615

High single-hole lavatory faucet, drain not included

- A- Max: 1.5 gpm - 60 psi
- B- Order your lavatory drain (pages 309- 310)
- C- Easy-to-clean adjustable silicone aerator
- D- CAR-1025-09

Ecological options

Codes	Reduced flow rates	CEC
B45-1020-00L-xx-120	1.2 gpm (4.5 l/min) - 60 psi	
B45-1020-00L-xx-100	1.0 gpm (3.7 l/min) - 60 psi	
B45-1020-00L-xx-050	0.5 gpm (1.9 l/min) - 60 psi	

CC	KK	LL	BB	NN/YY	VV/TT	GG
945	1229	1418	1418	1229	1512	2079

8" c/c lavatory faucet, drain included

- A- Max: 1.5 gpm - 60 psi
- B- Push-button drain with overflow included
- C- Easy-to-clean adjustable silicone aerator
- D- CAR-3820-01 (Cold), CAR-3820-02 (Hot)

Ecological options

Codes	Reduced flow rates	CEC
B45-8009-00L-xx-120	1.2 gpm (4.5 l/min) - 60 psi	
B45-8009-00L-xx-100	1.0 gpm (3.7 l/min) - 60 psi	
B45-8009-00L-xx-050	0.5 gpm (1.9 l/min) - 60 psi	

Actual products may differ from pictures. Actual products measures may differ from the measures shown. All USD prices are subject to change without notice. Effective as of August 2023.

SENS B45

B45-8100-04L-xx

COMPLETE FAUCET

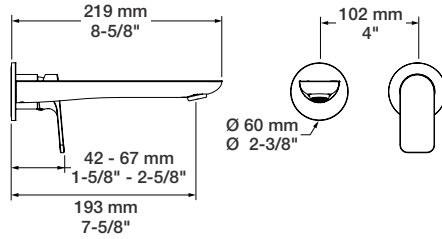

CC	KK	LL	BB	NN/YY	VV/TT	GG
779	1013	1168	1168	1013	1246	1714

Single lever wall-mounted lavatory faucet, drain not included

- A- 1.5 gpm - 60 psi
- B- Order your lavatory drain (pages 309- 310)
- C- Easy-to-clean adjustable silicone aerator
- D- One-piece rough for easy installation
- E- Large depth adjustment range
- F- CAR-1025-09

Ecological options

Codes	Reduced flow rates
B45-8100-04L-xx-120	1.2 gpm (4.5 l/min) - 60 psi
B45-8100-04L-xx-100	1.0 gpm (3.7 l/min) - 60 psi
B45-8100-04L-xx-050	0.5 gpm (1.9 l/min) - 60 psi

TRIM ONLY

T45-8100-04L-xx



CC	KK	LL	BB	NN/YY	VV/TT	GG
437	671	826	826	671	904	1372

ROUGH Please order the following rough to complete the trim:

ROU-8100-04-B

Single lever wall-mounted lavatory rough - 1/2" male NPT or welded copper connections

342

B45-1100-00-xx

COMPLETE FAUCET

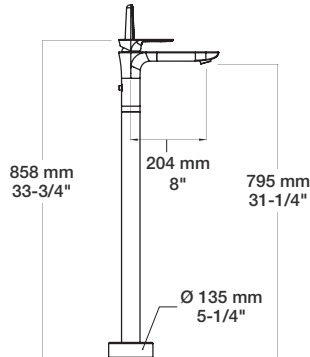

THE ESSENTIALS

CC	KK	LL	BB	NN/YY	VV/TT	GG
2282	2967	3423	3423	2967	3652	5021

Floor-mounted tub filler with hand shower

Bath spout:

- A- 8.5 gpm - 60 psi
- B- Tub spout with integrated push-button diverter

Hand shower:

- C- Max: 2 gpm - 80 psi
- D- Reclining hand shower holder
- F- Hand shower DOU-2653-01-xx
- G- CAR-1060-01
- H- PVC hose in KK finish or brass for other finishes

Ecological options

Codes	Reduced flow rates
B45-1100-00-xx-150	1.5 gpm (5.7 l/min) - 80 psi
B45-1100-00-xx-175	1.75 gpm (6.6 l/min) - 80 psi

TRIM ONLY

T45-1100-00-xx



CC	KK	LL	BB	NN/YY	VV/TT	GG
2147	2832	3288	3288	2832	3517	4886

MOUNTING KIT Please order the following kit to complete the trim:

FIX-1100-00-B

Floor mounting kit for floor-mounted tub filler with hand shower

135

B45-1269-00-xx

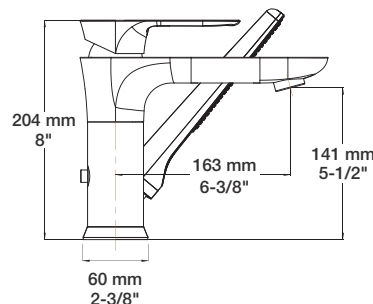

THE ESSENTIALS

CC	KK	LL	BB	NN/YY	VV/TT	GG
1125	1463	1688	1688	1463	1800	2475

2-piece tub filler with hand shower

- A- Double-walled faucet limiting heat conduction
- Bath spout:**
- B- 9.2 gpm - 60 psi
- C- Tub spout with integrated push-button diverter

Hand shower:

- D- Max: 2 gpm - 80 psi
- E- DOU-2653-01-xx
- F- CAR-1060-01

Ecological options

Codes	Reduced flow rates
B45-1269-00-xx-150	1.5 gpm (5.7 l/min) - 80 psi
B45-1269-00-xx-175	1.75 gpm (6.6 l/min) - 80 psi

Finishes:

CC = chrome, KK = matte black, LL = satin brass, BB = white, NN = brushed nickel, YY = polished nickel, TT = venetian bronze, VV = satin copper, GG = gold 137

SENS B45

B45-1600-00-xx

COMPLETE FAUCET

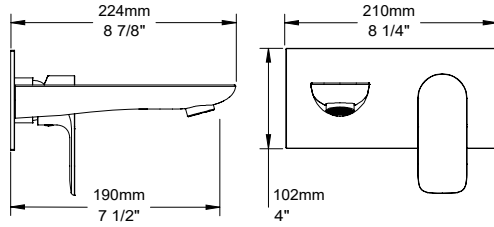
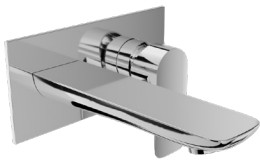

CC	KK	LL	BB	NN/YY	VV/TT	GG
1138	1480	1708	1708	1480	1822	2505

Wall-mounted tub faucet

- A- 5.3 gpm - 60 psi
- B- One-piece rough with wall plate for easy installation
- C- CAR-1031-49



TRIM ONLY

T45-1600-00-xx

CC	KK	LL	BB	NN/YY	VV/TT	GG
796	1138	1366	1366	1138	1480	2163

ROUGH Please order the following rough to complete the trim:

ROU-1600-03-B

Wall-mounted tub faucet rough - 1/2" male NPT or welded copper connections

342

B45-2002-00-xx

COMPLETE FAUCET

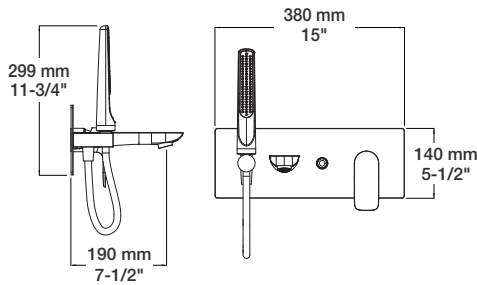

CC	KK	LL	BB	NN/YY	VV/TT	GG
2118	2753	3176	3176	2753	3388	4659

Wall-mounted tub faucet with hand shower

Bath spout:

A- 6.6 gpm - 60 psi

Hand shower:

B-Max: 2 gpm - 80 psi

- C- Robust and easy-to-use push-button diverter
- D- Push-button can be locked in the engaged position
- E- Easy to install one-piece rough
- F- DOU-2653-01-xx with 43" hose
- G- CAR-1060-01
- H- PVC hose in KK finish or brass for other finishes

Ecological options

Codes	Reduced flow rates
B45-2002-00-xx-150	1.5 gpm (5.7 l/min) - 80 psi
B45-2002-00-xx-175	1.75 gpm (6.6 l/min) - 80 psi

CEC

TRIM ONLY

T45-2002-00-xx

Cartridge included with the trim

CC	KK	LL	BB	NN/YY	VV/TT	GG
1556	2191	2614	2614	2191	2826	4097

ROUGH Please order the following rough to complete the trim:

ROU-2000-99-B

Wall-mounted tub faucet rough (without cartridge)- 1/2" female NPT connections

562

B45-9100-00-xx

ROUGH & TRIM PACKAGE

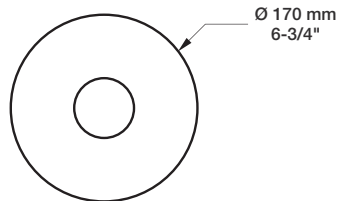

CC	KK	LL	BB	NN/YY	VV/TT	GG
635	733	798	798	733	830	1025

Complete pressure balanced shower control valve

- A- 6 gpm - 60 psi
- B- Volume control valve
- C- CAR-1020-40
- D- Rough valve RVA-9020-00-B included

TRIM ONLY

T45-9139-01-xx

CC	KK	LL	BB	NN/YY	VV/TT	GG
325	423	488	488	423	520	715

ROUGH VALVES Please order **one** of the following rough valves to complete the trim:

RVA-9020-00-B

Type P rough - 1/2" male NPT or welded copper connections

310

RVA-9020-P0-B

Type P rough - PEX connections

310

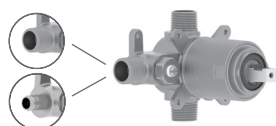

B45-9180-00-xx

ROUGH & TRIM PACKAGE

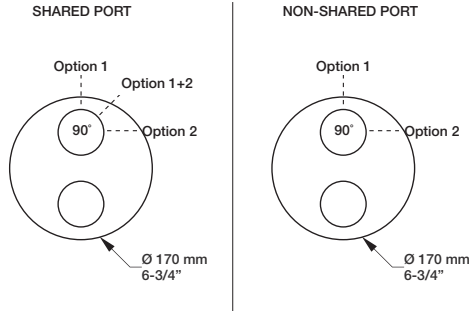

CC	KK	LL	BB	NN/YY	VV/TT	GG
822	926	996	996	926	1031	1240

Complete pressure balanced shower control valve with 2-way diverter (shared port)

- A- 1 outlet: 5 gpm - 60 psi, 2 outlets: 2.6 gpm - 60 psi
- B- Volume control valve
- C- Up to 2 accessories can be used at the same time
- D- CAR-1020-40 (volume), CAR-1001-35 (diverter)
- E- Rough valve RVA-9181-00-B included

Ecological options

Codes	Features
B45-9180-00-xx-NS	Non-shared port
T45-9180-01-xx + RVA-9181-00-NS-B	1 accessory works at a time
T45-9180-01-xx + RVA-9181-PO-NS-B	CAR-1001-35-NS (diverter)

TRIM ONLY

T45-9180-01-xx

CC	KK	LL	BB	NN/YY	VV/TT	GG
348	452	522	522	452	557	766

ROUGH VALVES Please order **one** of the following rough valves to complete the trim:

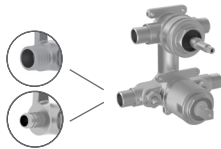

RVA-9181-00-B

2-way type P rough - 1/2" male NPT or welded copper connections

474

RVA-9181-PO-B

2-way type P rough - PEX connections

474

B45-9190-00-xx

ROUGH & TRIM PACKAGE

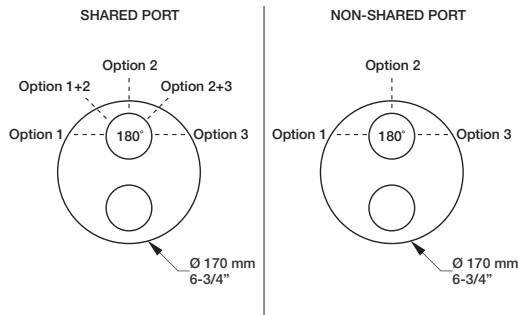

CC	KK	LL	BB	NN/YY	VV/TT	GG
877	981	1051	1051	981	1086	1295

Complete pressure balanced shower control valve with 3-way diverter (shared port)

- A- 1 outlet: 5 gpm - 60 psi, 2 outlets: 2.6 gpm - 60 psi
- B- Volume control valve
- C- Up to 2 accessories can be used at the same time
- D- CAR-1020-40 (volume), CAR-9220-02 (diverter)
- E- Rough valve RVA-9191-00-B included

Ecological options

Codes	Features
B45-9190-00-xx-NS	Non-shared port
T45-9190-01-xx + RVA-9191-00-NS-B	1 accessory works at a time
T45-9190-01-xx + RVA-9191-PO-NS-B	CAR-9220-02-NS (diverter)

TRIM ONLY

T45-9190-01-xx

CC	KK	LL	BB	NN/YY	VV/TT	GG
348	452	522	522	452	557	766

ROUGH VALVES Please order **one** of the following rough valves to complete the trim:

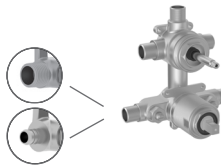

RVA-9191-00-B

3-way type P rough - 1/2" male NPT or welded copper connections

529

RVA-9191-PO-B

3-way type P rough - PEX connections

529

B45-9404-00-xx

ROUGH & TRIM PACKAGE

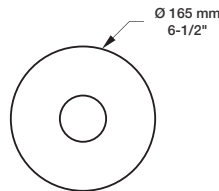

CC	KK	LL	BB	NN/YY	VV/TT	GG
1179	1328	1428	1428	1328	1477	1775

Complete 3/4" thermostatic valve

- A- 16 gpm - 60 psi
- B- Separate volume control or diverter valve required
- C- Can easily supply 3 accessories
- D- Thin brass plate
- E- CAR-3404-00
- F- Rough valve RVA-3404-00-B included
- G- Reversible check / non-return valves in case of water supply inversion

TRIM ONLY

T45-9404-00-xx

CC	KK	LL	BB	NN/YY	VV/TT	GG
497	646	746	746	646	795	1093

ROUGH VALVE Please order the following rough valve to complete the trim:



RVA-3404-00-B

Type T rough - 3/4" female NPT connections

682

Finishes:

CC = chrome, KK = matte black, LL = satin brass, BB = white, NN = brushed nickel, YY = polished nickel, TT = venetian bronze, VV = satin copper, GG = gold 139

SENS B45

B45-9453-00-xx

ROUGH & TRIM PACKAGE

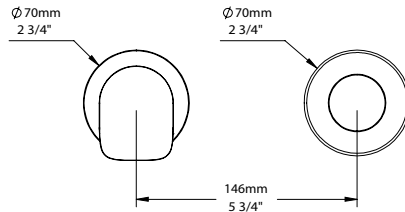

CC	KK	LL	BB	NN/YY	VV/TT	GG
1146	1295	1395	1395	1295	1444	1742

Complete 3/4" thermostatic valve

- A- 9 gpm - 60 psi
- B- Separate volume control or diverter valve required
- C- Can easily supply 3 accessories
- D- Hook on the side of the valve can be removed to give access to the check valves
- E- Reversible check / non-return valves in case of water supply inversion
- F- CAR-2661-00
- G- Rough valve RVA-3453-00-B included
- H- Large depth adjustment range

TRIM ONLY

T45-9453-00-xx

CC	KK	LL	BB	NN/YY	VV/TT	GG
497	646	746	746	646	795	1093



ROUGH VALVE Please order the following rough valve to complete the trim:

RVA-3453-00-B

Type T rough - 3/4" female NPT connections

649

THE ESSENTIALS

B45-9521-00-xx

ROUGH & TRIM PACKAGE

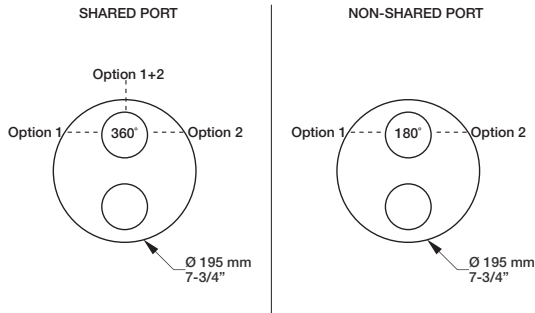

CC	KK	LL	BB	NN/YY	VV/TT	GG
1081	1200	1279	1279	1200	1319	1556

Complete thermostatic pressure balanced shower control valve with 2-way diverter (shared port)

- A - 1 outlet: 7.9 gpm - 60 psi, 2 outlets: 3.7 gpm - 60 psi
- B - Up to 2 accessories can be used at the same time
- C - Thin brass plate
- D - Reversible check / non-return valves in case of water supply inversion
- E - CAR-2661-00 (temperature), CAR-3003-36 (diverter)
- F - Rough valve RVA-9521-00-B included
- G - Large depth adjustment range

Ecological options CEC

Codes	Features
B45-9521-00-xx-NS	Non-shared port
T45-9521-00-xx + RVA-9521-00-NS-B	1 accessory works at a time
T45-9521-00-xx + RVA-9521-P0-NS-B	CAR-3003-36-NS (diverter)

TRIM ONLY

T45-9521-00-xx

CC	KK	LL	BB	NN/YY	VV/TT	GG
396	515	594	594	515	634	871

ROUGH VALVES Please order **one** of the following rough valves to complete the trim:

RVA-9521-00-B

2-way TP rough - 1/2" male NPT or welded copper connections

685

RVA-9521-P0-B

2-way TP rough - PEX connections

685

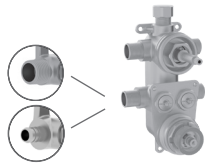

Actual products may differ from pictures. Actual products measures may differ from the measures shown. All USD prices are subject to change without notice. Effective as of August 2023.

B45-9531-00-xx

ROUGH & TRIM PACKAGE

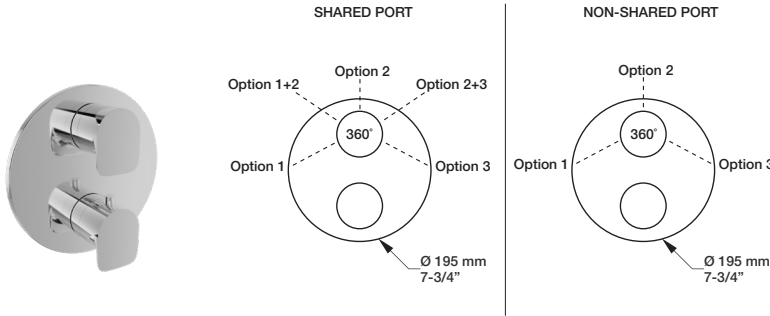

CC	KK	LL	BB	NN/YY	VV/TT	GG
1191	1310	1389	1389	1310	1429	1666

Complete thermostatic pressure balanced shower control valve with 3-way diverter (shared port)

- A - 1 outlet: 7.9 gpm - 60 psi, 2 outlets: 3.7 gpm - 60 psi
- B - Up to 2 accessories can be used at the same time
- C - Thin brass plate
- D - Reversible check / non-return valves in case of water supply inversion
- E - CAR-2661-00 (temperature), CAR-9531-03 (diverter)
- F - Rough valve RVA-9531-00-B included
- G - Large depth adjustment range

Ecological options CEC

Codes	Features
B45-9531-00-xx-NS	Non-shared port
T45-9531-00-xx + RVA-9531-00-NS-B	1 accessory works at a time
T45-9531-00-xx + RVA-9531-P0-NS-B	CAR-9531-03-NS (diverter)

TRIM ONLY

T45-9531-00-xx

CC	KK	LL	BB	NN/YY	VV/TT	GG
396	515	594	594	515	634	871

ROUGH VALVES Please order **one** of the following rough valves to complete the trim:

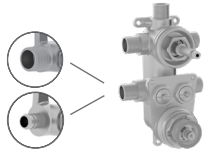

RVA-9531-00-B

3-way TP rough - 1/2" male NPT or welded copper connections

795

RVA-9531-P0-B

3-way TP rough - PEX connections

795

B45-9560-02-xx

ROUGH & TRIM PACKAGE

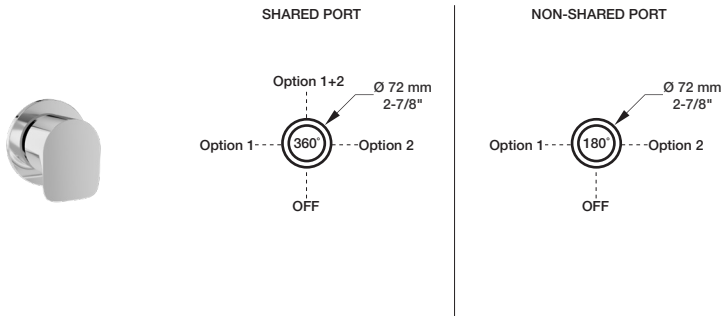

CC	KK	LL	BB	NN/YY	VV/TT	GG
498	558	598	598	558	617	737

Complete 2-port diverter with stop (shared port)

- A - 1 outlet: 10.5 gpm - 60 psi, 2 outlets: 4 gpm - 60 psi
- B - Can replace 2 volume control valves
- C - Up to 2 accessories can be used at the same time
- D - CAR-9525-02
- E - Rough RVA-9562-00-B included
- F - Extra long cartridge for maximum adjustment

Ecological options CEC

Codes	Features
B45-9560-02-xx-NS	Non-shared port
T45-9560-02-xx + RVA-9562-00-NS-B	1 accessory works at a time
	CAR-9525-02-NS (diverter)

TRIM ONLY

T45-9560-02-xx

CC	KK	LL	BB	NN/YY	VV/TT	GG
199	259	299	299	259	318	438

ROUGH VALVE Please order the following rough valve to complete the trim:



RVA-9562-00-B

2-port diverter rough - 1/2" male NPT or welded copper connections

299

Finishes:

CC = chrome, KK = matte black, LL = satin brass, BB = white, NN = brushed nickel, YY = polished nickel, TT = venetian bronze, VV = satin copper, GG = gold 141

SENS B45

B45-9560-03-xx

ROUGH & TRIM PACKAGE

CC	KK	LL	BB	NN/YY	VV/TT	GG
580	640	680	680	640	699	819

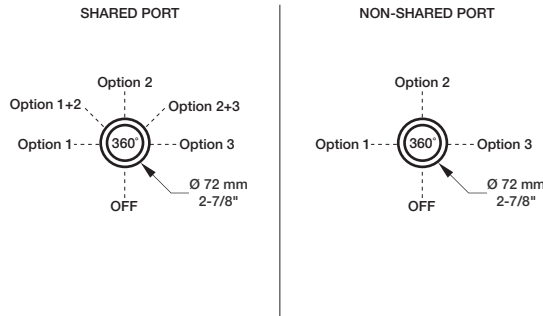

Complete 3-port diverter with stop (shared port)

- A- 1 outlet: 9.7 gpm - 60 psi, 2 outlets: 5.2 gpm - 60 psi
- B- Can replace 2 or 3 volume control valves
- C- Up to 2 accessories can be used at the same time
- D- CAR-9530-03
- E- Rough RVA-9563-00-B included
- F- Extra long cartridge for maximum adjustment

Ecological options CEC

Codes	Features
B45-9560-03-xx-NS	Non-shared port
T45-9560-03-xx + RVA-9563-00-NS-B	1 accessory works at a time CAR-9530-03-NS (diverter)

TRIM ONLY

T45-9560-03-xx

CC	KK	LL	BB	NN/YY	VV/TT	GG
199	259	299	299	259	318	438

ROUGH VALVE Please order the following rough valve to complete the trim:

RVA-9563-00-B

3-port diverter rough - inlet: 3/4" F NPT - outlets: 1/2" F NPT

381



B45-9600-00-xx

ROUGH & TRIM PACKAGE

CC	KK	LL	BB	NN/YY	VV/TT	GG
373	433	473	473	433	492	612

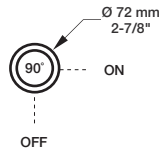

Complete 1/2" volume control valve

- A- 7.9 gpm - 60 psi
- B- Volume control valve
- C- CAR-1011-81
- D- Rough valve RVA-2020-01-B included
- E- Extra long cartridge for maximum adjustment

TRIM ONLY

T45-9600-00-xx

CC	KK	LL	BB	NN/YY	VV/TT	GG
199	259	299	299	259	318	438

ROUGH VALVE Please order the following rough valve to complete the trim:

RVA-2020-01-B

Volume control valve rough - 1/2" female NPT connections

174

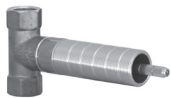

B45-9649-00-xx

ROUGH & TRIM PACKAGE

CC	KK	LL	BB	NN/YY	VV/TT	GG
434	494	534	534	494	553	673

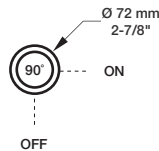

Complete 3/4" volume control valve

- A- 11.1 gpm - 60 psi
- B- Volume control valve
- C- Offers higher flow
- D- CAR-2719-34
- E- Rough valve RVA-2719-34-B included
- F- Extra long cartridge for maximum adjustment

TRIM ONLY

T45-9649-00-xx

CC	KK	LL	BB	NN/YY	VV/TT	GG
199	259	299	299	259	318	438

ROUGH VALVE Please order the following rough valve to complete the trim:

RVA-2719-34-B

Volume control valve rough - 3/4" female NPT connections

235



Actual products may differ from pictures. Actual products measures may differ from the measures shown. All USD prices are subject to change without notice. Effective as of August 2023.

SENS B45

SELECTION OF SHOWER COMPONENTS

For more shower components and for ecological options, please refer to the shower components section (see p. 347-382).

TET-0810-01-xx
8" round shower head



CC	KK	LL	BB
445	579	668	668

TET-1010-01-xx
10" round shower head



CC	KK	LL	BB
575	748	863	863

TET-1213-01-xx
12" round shower head

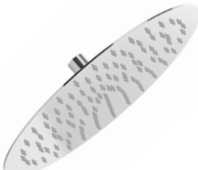

CC
572

TET-1208-01-xx
12" x 8" rectangular shower head



CC	KK
462	601

BRA-1409-02-xx
15" L-shaped shower arm



CC	KK	LL	BB
314	408	471	471

TET-0813-01-xx
8" round shower head



CC
310

TET-1013-01-xx
10" round shower head



CC	KK
416	541

TET-1613-01-xx
16" round shower head



CC
809

TET-2012-01-xx
20" x 12" rectangular shower head

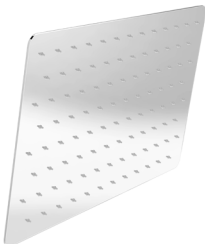

CC
965

BRA-1812-02-xx
18" shower arm



CC	KK	LL	BB
168	218	252	252

BRA-1815-02-xx
18" shower arm



CC	KK	LL	BB
325	423	488	488

DGL-2070-57-xx
3-spray sliding shower bar



CC	KK	LL	BB
594	772	891	891

DGL-2580-53-xx
3-spray sliding shower bar



CC	KK	LL	BB
594	772	891	891

DGL-3080-73-xx
3-spray sliding shower bar



CC	KK	LL	BB
749	974	1124	1124

DGL-3097-73-xx
Shower column with hand shower, head not included



CC	KK	LL	BB
999	1299	1499	1499

RAC-9001-16-xx
1/2" F wall-mount supply elbow



CC	KK	LL	BB
124	161	186	186

RAC-9201-02-xx
1/2" F wall-mount supply elbow with integrated volume control



CC	KK	LL	BB
199	259	299	299

BEC-0520-45-xx
Sens tub spout without diverter



CC	KK	LL	BB
424	551	636	636

BEC-0520-73-xx
7" round tub spout without diverter



CC	KK	LL	BB
168	218	252	252

BEC-0520-74-xx
7" round tub spout with diverter



CC	KK	LL	BB
198	257	297	297

BOD-5002-01-xx
Cylindrical lateral body jet



CC	KK	LL	BB
199	259	299	299

BOD-5007-01-xx
Round built-in lateral body jet



CC	KK	LL	BB
325	423	488	488

Actual products may differ from pictures. Actual products measures may differ from the measures shown. All USD prices are subject to change without notice. Effective as of August 2023.

COMPLETE SHOWER KITS

PRO-1100-53-xx



Complete thermostatic shower kit on column

CC	KK	LL	BB	NN/YY	VV/TT	GG
1775	2308	2663	2663	2308	2840	3905

Features

- A- Max: 2 gpm - 80 psi (per accessory)
- B- 3-spray push-button hand shower
- C- 2 accessories can work together
- D- Temperature handle on the hot water inlet side, allowing the surface temperature to never exceed the shower water temperature
- E- Shower head arm adjustable up to 20" in height
- F- Easy to move metal slider with built-in hook
- G- Thermostatic cartridge: CAR-2661-00
- H- Diverter cartridge: CAR-3003-36

Ecological options	Code	Features are the same, except:
CEC	PRO-1100-53-xx-NS	A- Max: 1.75 gpm - 80 psi (per accessory) C- 1 accessory works at a time H- Diverter cartridge: CAR-3003-36

PRO-2105-45-xx



Complete pressure balanced shower kit

CC	KK	LL	BB	NN/YY	VV/TT	GG
1175	1528	1763	1763	1528	1880	2585

Features

- A- Max: 2 gpm - 80 psi
- B- 3-spray hand shower

Includes

- B45-9100-00-xx** Complete type P valve
- DGL-2580-53-xx** 3-spray sliding shower bar
- RAC-9001-16-xx** Elbow connector

Ecological option	Codes	Features are the same, except:
CEC	PRO-2105-45-xx-175 TRO-2105-45-xx-175 + RVA-9020-00-B	A- Max: 1.75 gpm - 80 psi (hand shower)

TRIM ONLY

TRO-2105-45-xx	CC	KK	LL	BB	NN/YY	VV/TT	GG
	865	1218	1453	1453	1218	1570	2275

ROUGH VALVES Please order **one** of the following rough valves to complete the trim:

RVA-9020-00-B	Type P rough - 1/2" male NPT or welded copper connections	310
RVA-9020-P0-B	Type P rough - PEX connections	310

PRO-2805-45-xx

PRR-2805-45-xx*



Complete pressure balanced shower kit

CC	KK	LL	BB	NN/YY	VV/TT	GG
1798	2337	2697	2697	2337	2877	3956

Features

- A- 2 accessories kit
- B- Max: 2 gpm - 80 psi (per accessory)
- C- 3-spray hand shower
- D- 2 accessories can work together

Includes

- B45-9180-00-xx** Complete type P valve with 2-way diverter
- TET-0810-01-xx** 8" round shower head
- BRA-1812-02-xx** 18" shower arm
- DGL-2580-53-xx** 3-spray sliding shower bar
- RAC-9001-16-xx** Wall-mount supply elbow

Ecological options	Codes	Features are the same, except:
CEC	PRO-2805-45-xx-NS TRO-2805-45-xx-NS + RVA-9181-00-NS-B	B- Max: 1.75 gpm - 80 psi (per accessory) D- 1 accessory works at a time

TRIM ONLY

TRO-2805-45-xx	CC	KK	LL	BB	NN/YY	VV/TT	GG
TRR-2805-45-xx*	1324	1863	2223	2223	1863	2403	3482

ROUGH VALVES Please order **one** of the following rough valves to complete the trim:

RVA-9181-00-B	2-way type P rough - 1/2" male NPT or welded copper connections	474
RVA-9181-P0-B	2-way type P rough - PEX connections	474

Finishes:

CC = chrome, KK = matte black, LL = satin brass, BB = white, NN = brushed nickel, YY = polished nickel, TT = venetian bronze, VV = satin copper, GG = gold

* With 6" ceiling mount shower arm

SENS B45

PRO-2815-45-xx PRR-2815-45-xx*

Complete pressure balanced shower kit

CC	KK
1545	2009

Features

- A- 2 accessories kit
- B- Max: 2 gpm - 80 psi (per accessory)
- C- 3-spray hand shower
- D- 2 accessories can work together

Includes

- B45-9180-00-xx** Complete type P valve with 2-way diverter
- TET-1013-01-xx** 10" round shower head
- BRA-1812-02-xx** 18" shower arm
- DGL-2580-53-xx** 3-spray sliding shower bar
- RAC-9001-26-xx** Wall-mount supply elbow

Ecological options CEC

Codes	Features are the same, except:
PRO-2815-45-xx-NS	B- Max: 1.75 gpm - 80 psi (per accessory)
TRO-2815-45-xx-NS + RVA-9181-00-NS-B	D- 1 accessory works at a time

TRIM ONLY

TRO-2815-45-xx TRR-2815-45-xx*	CC	KK
	1071	1535

ROUGH VALVES Please order **one** of the following rough valves to complete the trim:

RVA-9181-00-B	2-way type P rough - 1/2" male NPT or welded copper connections	474
RVA-9181-PO-B	2-way type P rough - PEX connections	474

PRO-2896-45-xx PRR-2896-45-xx*

Complete pressure balanced shower kit

CC	KK	LL	BB	NN/YY	VV/TT	GG
1575	2048	2363	2363	2048	2520	3465

Features

- A- 2 accessories kit
- B- Max: 2 gpm - 80 psi (per accessory)
- C- 1-spray hand shower
- D- 2 accessories can work together

Includes

- B45-9180-00-xx** Complete pressure balanced valve with 2-way diverter
- TET-0810-01-xx** 8" round shower head
- BRA-1812-02-xx** 18" shower arm
- DSP-2604-19-xx** Hand shower on wall-mounted supply elbow

Ecological options CEC

Codes	Features are the same, except:
PRO-2896-45-xx-NS	B- Max: 1.75 gpm - 80 psi (per accessory)
TRO-2896-45-xx-NS + RVA-9181-00-NS-B	D- 1 accessory works at a time

TRIM ONLY

TRO-2896-45-xx TRR-2896-45-xx*	CC	KK	LL	BB	NN/YY	VV/TT	GG
	1101	1574	1889	1889	1574	2046	2991

ROUGH VALVES Please order **one** of the following rough valves to complete the trim:

RVA-9181-00-B	2-way type P rough - 1/2" male NPT or welded copper connections	474
RVA-9181-PO-B	2-way type P rough - PEX connections	474

PRO-2915-45-xx PRR-2915-45-xx*

Complete pressure balanced shower kit

CC	KK
1719	2235

Features

- A- 3 accessories kit
- B- 5 gpm - 60 psi (bath spout)
- C- Max: 2 gpm - 80 psi (shower accessories)
- D- 3-spray hand shower
- E- 2 accessories can work together

Includes

- B45-9190-00-xx** Complete type P valve with 3-way diverter
- BEC-0520-73-xx** 7" round tub spout without diverter
- TET-1013-01-xx** 10" round shower head
- BRA-1812-02-xx** 18" shower arm
- DGL-2580-53-xx** 3-spray sliding shower bar
- RAC-9001-26-xx** Wall-mount supply elbow

Ecological options CEC

Codes	Features are the same, except:
PRO-2915-45-xx-NS	C- Max: 1.75 gpm - 80 psi (shower accessories)
TRO-2915-45-xx-NS + RVA-9191-00-NS-B	E- 1 accessory works at a time

TRIM ONLY

TRO-2915-45-xx TRR-2915-45-xx*	CC	KK
	1071	1535

ROUGH VALVES Please order **one** of the following rough valves to complete the trim:

RVA-9191-00-B	3-way type P rough - 1/2" male NPT or welded copper connections	529
RVA-9191-PO-B	3-way type P rough - PEX connections	529

PRO-3302-45-xx

PRR-3302-45-xx*



Complete thermostatic shower kit

CC	KK	LL	BB	NN/YY	VV/TT	GG
2435	3166	3653	3653	3166	3896	5357

Features

- A- 2 accessories kit
- B- Max: 2 gpm - 80 psi (per accessory)
- C- 1-spray hand shower
- D- 2 accessories can work together
- E- Hook as part of the thermostatic valve trim

Includes

- B45-9453-00-xx** Complete 3/4" thermostatic valve
- B45-9560-02-xx** Complete 2-port diverter with off
- TET-1010-01-xx** 10" round shower head
- BRA-1812-02-xx** 18" shower arm
- DSP-2604-21-xx** Hand shower on wall-mounted supply elbow

Ecological options CEC

Codes

PRO-3302-45-xx-NS
 TRO-3302-45-xx-NS + RVA-3453-00-B +
 RVA-9562-00-NS-B

Features are the same, except:

B- Max: 1.75 gpm - 80 psi (per accessory)
 D- 1 accessory works at a time

TRIM ONLY

TRO-3302-45-xx
 TRR-3302-45-xx*

CC	KK	LL	BB	NN/YY	VV/TT	GG
1487	2218	2705	2705	2218	2948	4409

ROUGH VALVES Please order **all** of the following rough valves to complete the trim:

RVA-3453-00-B

Type T rough - 3/4" female NPT connections

649

RVA-9562-00-B

2-port diverter rough - 1/2" male NPT or welded copper connections

299

PRO-3405-45-xx

PRR-3405-45-xx*



Complete thermostatic shower kit

CC	KK	LL	BB	NN/YY	VV/TT	GG
2495	3244	3743	3743	3244	3992	5489

Features

- A- 2 accessories kit
- B- Max: 2 gpm - 80 psi (per accessory)
- C- 3-spray hand shower
- D- 2 accessories can work together

Includes

- B45-9404-00-xx** Complete 3/4" thermostatic valve
- B45-9560-02-xx** Complete 2-port diverter with stop
- TET-1010-01-xx** 10" round shower head
- BRA-1812-02-xx** 18" shower arm
- DGL-2580-53-xx** 3-spray sliding shower bar
- RAC-9001-16-xx** Wall-mount supply elbow

Ecological options CEC

Codes

PRO-3405-45-xx-NS
 TRO-3405-45-xx-NS + RVA-3404-00-B +
 RVA-9562-00-NS-B

Features are the same, except:

B- Max: 1.75 gpm - 80 psi (per accessory)
 D- 1 accessory works at a time

TRIM ONLY

TRO-3405-45-xx
 TRR-3405-45-xx*

CC	KK	LL	BB	NN/YY	VV/TT	GG
1514	2263	2762	2762	2263	3011	4508

ROUGH VALVES Please order **all** of the following rough valves to complete the trim:

RVA-3404-00-B

Type T rough - 3/4" female NPT connections

682

RVA-9562-00-B

2-port diverter rough - 1/2" male NPT or welded copper connections

299

THE ESSENTIALS

PRO-4206-45-xx

PRR-4206-45-xx*



Complete thermostatic pressure balanced shower kit

CC	KK	LL	BB	NN/YY	VV/TT	GG
1945	2529	2918	2918	2529	3112	4279

Features

- A- 2 accessories kit
- B- Max: 2 gpm - 80 psi (per accessory)
- C- 3-spray hand shower
- D- 2 accessories can work together

Includes

- B45-9521-00-xx** Complete TP shower control valve with 2-way diverter
- TET-0810-01-xx** 8" round shower head
- BRA-1812-02-xx** 18" shower arm
- DGL-2580-53-xx** 3-spray sliding shower bar
- RAC-9001-16-xx** Wall-mount supply elbow

Ecological options CEC

Codes

PRO-4206-45-xx-NS
 TRO-4206-45-xx-NS + RVA-9521-00-NS-B

Features are the same, except:

B- Max: 1.75 gpm - 80 psi (per accessory)
 D- 1 accessory works at a time

TRIM ONLY

TRO-4206-45-xx
 TRR-4206-45-xx*

CC	KK	LL	BB	NN/YY	VV/TT	GG
1260	1844	2233	2233	1844	2427	3594

ROUGH VALVES Please order **one** of the following rough valves to complete the trim:

RVA-9521-00-B

2-way TP rough - 1/2" male NPT or welded copper connections

685

RVA-9521-PO-B

2-way TP rough - PEX connections

685

Finishes:

CC = chrome, KK = matte black, LL = satin brass, BB = white, NN = brushed nickel, YY = polished nickel, TT = venetian bronze, VV = satin copper, GG = gold

* With 6" ceiling mount shower arm

SENS B45

PRO-4216-45-xx PRR-4216-45-xx*

Complete thermostatic pressure balanced shower kit

CC	KK
1795	2334



Features

- A- 2 accessories kit
- B- Max: 2 gpm - 80 psi (per accessory)
- C- 3-spray hand shower
- D- 2 accessories can work together

Includes

- B45-9521-00-xx** Complete TP shower control valve with 2-way diverter
- TET-1013-01-xx** 10" round shower head
- BRA-1812-02-xx** 18" shower arm
- DGL-2580-53-xx** 3-spray sliding shower bar
- RAC-9001-26-xx** Wall-mount supply elbow

Ecological options CEC

Codes

PRO-4216-45-xx-NS
TRO-4216-45-xx-NS + RVA-9521-00-NS-B

Features are the same, except:

B- Max: 1.75 gpm - 80 psi (per accessory)
D- 1 accessory works at a time

TRIM ONLY

TRO-4216-45-xx TRR-4216-45-xx*

CC	KK
1110	1649

ROUGH VALVES Please order **one** of the following rough valves to complete the trim:

RVA-9521-00-B

2-way TP rough - 1/2" male NPT or welded copper connections

685

RVA-9521-P0-B

2-way TP rough - PEX connections

685

PRO-4297-45-xx PRR-4297-45-xx*

Complete thermostatic pressure balanced shower kit

CC	KK	LL	BB	NN/YY	VV/TT	GG
1695	2204	2543	2543	2204	2712	3729



Features

- A- 2 accessories kit
- B- Max: 2 gpm - 80 psi (per accessory)
- C- 3-spray hand shower
- D- 2 accessories can work together

Includes

- B45-9521-00-xx** Complete TP shower control valve with 2-way diverter
- TET-0810-01-xx** 8" round shower head
- BRA-1812-02-xx** 18" shower arm
- DSP-2574-19-xx** Hand shower on wall-mounted supply elbow

Ecological options CEC

Codes

PRO-4297-45-xx-NS
TRO-4297-45-xx-NS + RVA-9521-00-NS-B

Features are the same, except:

B- Max: 1.75 gpm - 80 psi (per accessory)
D- 1 accessory works at a time

TRIM ONLY

TRO-4297-45-xx TRR-4297-45-xx*

CC	KK	LL	BB	NN/YY	VV/TT	GG
1010	1519	1858	1858	1519	2027	3044

ROUGH VALVES Please order **one** of the following rough valves to complete the trim:

RVA-9521-00-B

2-way TP rough - 1/2" male NPT or welded copper connections

685

RVA-9521-P0-B

2-way TP rough - PEX connections

685

THE ESSENTIALS

PRO-4306-45-xx PRR-4306-45-xx*

Complete thermostatic pressure balanced shower kit

CC	KK	LL	BB	NN/YY	VV/TT	GG
2420	3146	3630	3630	3146	3872	5324



Features

- A- 3 accessories kit
- B- 7.9 gpm - 60 psi (bath spout)
- C- Max: 2 gpm - 80 psi (shower accessories)
- D- 3-spray hand shower
- E- 2 accessories can work together

Includes

- B45-9531-00-xx** Complete TP shower control valve with 3-way diverter
- BEC-0520-45-xx** Sens tub spout without diverter
- TET-0810-01-xx** 8" shower head
- BRA-1812-02-xx** 18" shower arm
- DGL-2580-53-xx** 3-spray sliding shower bar
- RAC-9001-16-xx** Wall-mount supply elbow

Ecological options CEC

Codes

PRO-4306-45-xx-NS
TRO-4306-45-xx-NS + RVA-9531-00-NS-B

Features are the same, except:

C- Max: 1.75 gpm - 80 psi (shower accessories)
E- 1 accessory works at a time

TRIM ONLY

TRO-4306-45-xx TRR-4306-45-xx*

CC	KK	LL	BB	NN/YY	VV/TT	GG
1625	2351	2835	2835	2351	3077	4529

ROUGH VALVES Please order **one** of the following rough valves to complete the trim:

RVA-9531-00-B

3-way TP rough - 1/2" male NPT or welded copper connections

795

RVA-9531-P0-B

3-way TP rough - PEX connections

795

SELECTION OF BATHROOM ACCESSORIES

For more bathroom accessories, please refer to the bathroom accessories section (see p. 293-306).

A46-1029-00-xx
PROFILE
 Wall-mounted toilet paper holder



CC	KK	LL	BB	NN/YY	VV/TT	GG
226	294	339	339	294	361	497

A46-1069-00-xx
PROFILE
 Bathrobe holder



CC	KK	LL	BB	NN/YY	VV/TT	GG
126	164	189	189	164	202	277

A46-6012-00-xx
PROFILE
 12" single towel bar

Available Q3 2023



CC	KK	LL	BB	NN/YY	VV/TT	GG
292	380	438	438	380	467	642

A46-6018-00-xx
PROFILE
 18" single towel bar



CC	KK	LL	BB	NN/YY	VV/TT	GG
322	419	483	483	419	515	708

A46-6024-00-xx
PROFILE
 24" single towel bar



CC	KK	LL	BB	NN/YY	VV/TT	GG
364	473	546	546	473	582	800

A46-6030-00-xx
PROFILE
 30" single towel bar



CC	KK	LL	BB	NN/YY	VV/TT	GG
439	570	658	658	570	702	965

A85-9077-00-xx
 Corner basket



CC
248

Finishes:

CC = chrome, KK = matte black, LL = satin brass, BB = white, NN = brushed nickel, YY = polished nickel, TT = venetian bronze, VV = satin copper, GG = gold 149

PROFILE B46

Compatible with the Touchless Sensor
Order ELE-2001-01-xx (p. 43)



BARIL

PROFILE B46

B46-1010-1PL-xx

DRAIN INCLUDED

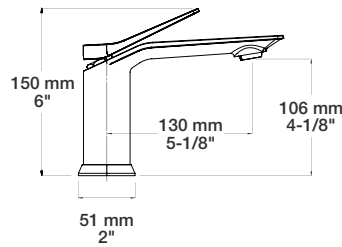

CC	KK	LL	BB	NN/YY	VV/TT	GG
625	813	938	938	813	1000	1375

Single-hole lavatory faucet, drain included

- A- Max: 1.5 gpm - 60 psi
- B- Easy-to-clean adjustable silicone aerator
- C- CAR-1025-05
- D- Push-button drain with overflow included

Ecological options

Codes	Reduced flow rates	CEC
B46-1010-XXL-xx-120	1.2 gpm (4.5 l/min) - 60 psi	
B46-1010-XXL-xx-100	1.0 gpm (3.7 l/min) - 60 psi	
B46-1010-XXL-xx-050	0.5 gpm (1.9 l/min) - 60 psi	

DRAIN NOT INCLUDED

B46-1010-00L-xx

D- Order your lavatory drain (pages 309-310)

CC	KK	LL	BB	NN/YY	VV/TT	GG
577	750	866	866	750	923	1264

B46-1020-00L-xx

DRAIN NOT INCLUDED

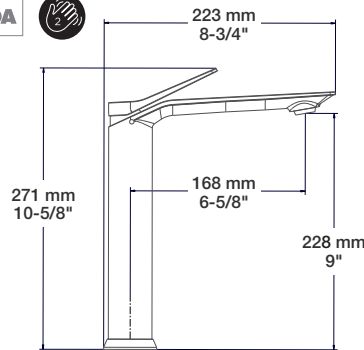

CC	KK	LL	BB	NN/YY	VV/TT	GG
775	1008	1163	1163	1008	1240	1705

High single-hole lavatory faucet, drain not included

- A- Max: 1.5 gpm - 60 psi
- B- Order your lavatory drain (pages 309-310)
- C- Easy-to-clean adjustable silicone aerator
- D- CAR-1025-05

Ecological options

Codes	Reduced flow rates	CEC
B46-1020-00L-xx-120	1.2 gpm (4.5 l/min) - 60 psi	
B46-1020-00L-xx-100	1.0 gpm (3.7 l/min) - 60 psi	
B46-1020-00L-xx-050	0.5 gpm (1.9 l/min) - 60 psi	

B46-1030-1PL-xx

DRAIN INCLUDED

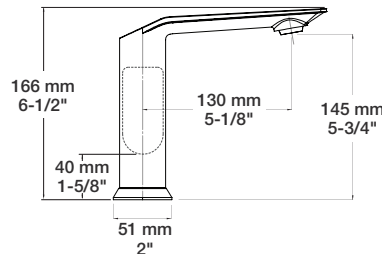

CC	KK	LL	BB	NN/YY	VV/TT	GG
739	961	1109	1109	961	1182	1626

Single-hole lavatory faucet, drain included

- A- Max: 1.5 gpm - 60 psi
- B- Easy-to-clean adjustable silicone aerator
- C- Side handle
- D- CAR-1025-08
- E- Push-button drain with overflow included

Ecological options

Codes	Reduced flow rates	CEC
B46-1030-XXL-xx-120	1.2 gpm (4.5 l/min) - 60 psi	
B46-1030-XXL-xx-100	1.0 gpm (3.7 l/min) - 60 psi	
B46-1030-XXL-xx-050	0.5 gpm (1.9 l/min) - 60 psi	

DRAIN NOT INCLUDED

B46-1030-00L-xx

E- Order your lavatory drain (pages 309-310)

CC	KK	LL	BB	NN/YY	VV/TT	GG
691	898	1037	1037	898	1105	1515

B46-1035-1PL-xx

DRAIN INCLUDED

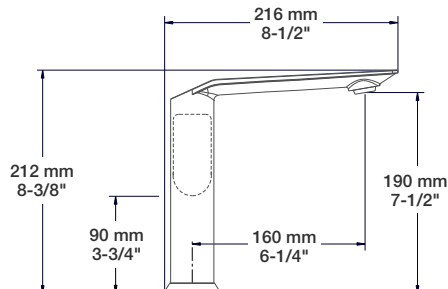

CC	KK	LL	BB	NN/YY	VV/TT	GG
895	1164	1343	1343	1164	1432	1969

Medium single-hole lavatory faucet, drain not included

- A- Max: 1.5 gpm - 60 psi
- B- For semi-recessed sink with high rim
- C- Side handle
- D- Easy-to-clean adjustable silicone aerator
- E- CAR-1025-08
- F- Push-button drain with overflow included

Ecological options

Codes	Reduced flow rates	CEC
B46-1035-XXL-xx-120	1.2 gpm (4.5 l/min) - 60 psi	
B46-1035-XXL-xx-100	1.0 gpm (3.7 l/min) - 60 psi	
B46-1035-XXL-xx-050	0.5 gpm (1.9 l/min) - 60 psi	

DRAIN NOT INCLUDED

B46-1035-00L-xx

F- Order your lavatory drain (pages 309-310)

CC	KK	LL	BB	NN/YY	VV/TT	GG
847	1101	1271	1271	1101	1355	1858

Actual products may differ from pictures. Actual products measures may differ from the measures shown. All USD prices are subject to change without notice. Effective as of August 2023.

PROFILE B46

B46-1040-00L-xx

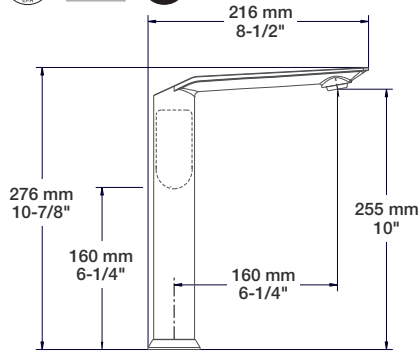

CC	KK	LL	BB	NN/YY	VV/TT	GG
875	1138	1313	1313	1138	1400	1925

High single-hole lavatory faucet, drain not included

- A- Max: 1.5 gpm - 60 psi
- B- Order your lavatory drain (pages 309- 310)
- C- Side handle
- D- Easy-to-clean adjustable silicone aerator
- E- CAR-1025-08

Ecological options

Codes	Reduced flow rates	CEC
B46-1040-00L-xx-120	1.2 gpm (4.5 l/min) - 60 psi	
B46-1040-00L-xx-100	1.0 gpm (3.7 l/min) - 60 psi	
B46-1040-00L-xx-050	0.5 gpm (1.9 l/min) - 60 psi	

B46-8009-00L-xx

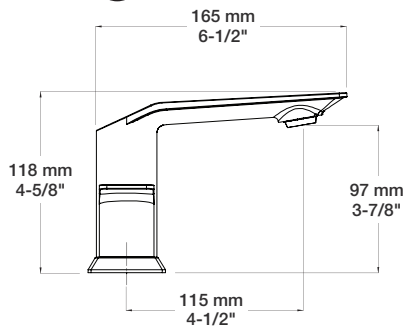

CC	KK	LL	BB	NN/YY	VV/TT	GG
975	1268	1463	1463	1268	1560	2145

8" c/c lavatory faucet, drain included

- A- Max: 1.5 gpm - 60 psi
- B- Push-button drain with overflow included
- C- Easy-to-clean adjustable silicone aerator
- D- CAR-3820-01 (Cold), CAR-3820-02 (Hot)

Ecological options

Codes	Reduced flow rates	CEC
B46-8009-00L-xx-120	1.2 gpm (4.5 l/min) - 60 psi	
B46-8009-00L-xx-100	1.0 gpm (3.7 l/min) - 60 psi	
B46-8009-00L-xx-050	0.5 gpm (1.9 l/min) - 60 psi	

B46-8100-04L-xx

COMPLETE FAUCET

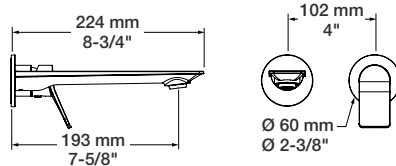

CC	KK	LL	BB	NN/YY	VV/TT	GG
795	1034	1193	1193	1034	1272	1749

Single lever wall-mounted lavatory faucet, drain not included

- A- 1.5 gpm - 60 psi
- B- Order your lavatory drain (pages 309- 310)
- C- Easy-to-clean adjustable silicone aerator
- D- One-piece rough for easy installation
- E- Large depth adjustment range
- F- CAR-1025-09

Ecological options

Codes	Reduced flow rates	CEC
B46-8100-04L-xx-120	1.2 gpm (4.5 l/min) - 60 psi	
B46-8100-04L-xx-100	1.0 gpm (3.7 l/min) - 60 psi	
B46-8100-04L-xx-050	0.5 gpm (1.9 l/min) - 60 psi	

TRIM ONLY



T46-8100-04L-xx

CC	KK	LL	BB	NN/YY	VV/TT	GG
453	692	851	851	692	930	1407

ROUGH Please order the following rough to complete the trim:

ROU-8100-04-B

Single lever wall-mounted lavatory rough - 1/2" male NPT or welded copper connections

342

Finishes:

CC = chrome, KK = matte black, LL = satin brass, BB = white, NN = brushed nickel, YY = polished nickel, TT = venetian bronze, VV = satin copper, GG = gold 153

PROFILE B46

B46-1100-00-xx

COMPLETE FAUCET

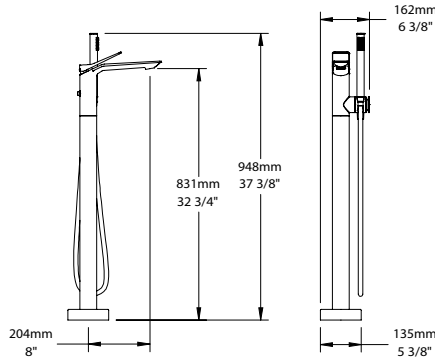

CC	KK	LL	BB	NN/YY	VV/TT	GG
2395	3114	3593	3593	3114	3832	5269

Floor-mounted tub filler with hand shower

Bath spout:

- A- 7.1 gpm - 60 psi
- B- Tub spout with integrated push-button diverter

Hand shower:

- C- Max: 2 gpm - 80 psi
- D- Reclining hand shower holder
- E- Built-in hook on the hand shower holder
- F- Hand shower DOU-2604-01-xx
- G- 59" PVC hose in CC and KK finishes or brass for other finishes
- H- CAR-1031-49

Ecological options

Codes	Reduced flow rates
B46-1100-00-xx-150	1.5 gpm (5.7 l/min) - 80 psi
B46-1100-00-xx-175	1.75 gpm (6.6 l/min) - 80 psi

TRIM ONLY

T46-1100-00-xx



MOUNTING KIT Please order the following kit to complete the trim:

FIX-1100-00-B

Floor mounting kit for floor-mounted tub filler with hand shower

135

CC	KK	LL	BB	NN/YY	VV/TT	GG
2260	2979	3458	3458	2979	3697	5134

B46-1249-00-xx

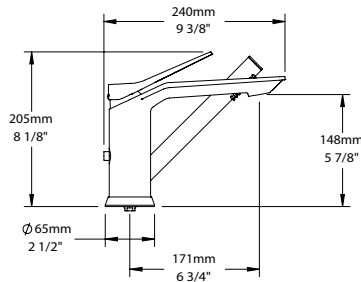

CC	KK	LL	BB	NN/YY	VV/TT	GG
1195	1554	1793	1793	1554	1912	2629

2-piece tub filler with hand shower

Bath spout:

- A- 7.1 gpm - 60 psi
- B- Tub spout with integrated push-button diverter

Hand shower:

- C- Max: 2 gpm - 80 psi
- D- DOU-2604-01-xx
- E- CAR-1031-49

Ecological options

Codes	Reduced flow rates
B46-1249-00-xx-150	1.5 gpm (5.7 l/min) - 80 psi
B46-1249-00-xx-175	1.75 gpm (6.6 l/min) - 80 psi

B46-2001-00-xx

COMPLETE FAUCET

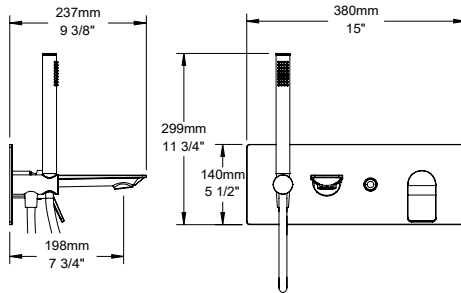
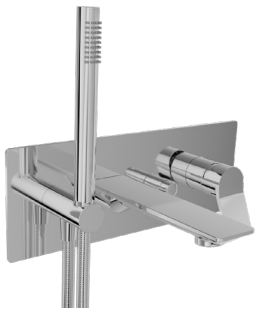

CC	KK	LL	BB	NN/YY	VV/TT	GG
2118	2753	3176	3176	2753	3388	4659

Wall-mounted tub faucet with hand shower

Bath spout:

- A- 6.6 gpm - 60 psi

Hand shower:

- B- Max: 2 gpm - 80 psi
- C- Robust and easy-to-use push-button diverter
- D- Push-button can be locked in the engaged position
- E- Easy to install one-piece rough
- F- DOU-2604-01-xx
- G- CAR-1060-01
- H- PVC hose in CC and KK finishes or brass for other finishes

Ecological options

Codes	Reduced flow rates
B46-2001-00-xx-150	1.5 gpm (5.7 l/min) - 80 psi
B46-2001-00-xx-175	1.75 gpm (6.6 l/min) - 80 psi

TRIM ONLY

T46-2001-00-xx

Cartridge included with the trim

ROUGH Please order the following rough to complete the trim:

ROU-2000-99-B

Wall-mounted tub faucet rough (without cartridge) - 1/2" female NPT connections

562

CC	KK	LL	BB	NN/YY	VV/TT	GG
1556	2191	2614	2614	2191	2826	4097

Actual products may differ from pictures. Actual products measures may differ from the measures shown. All USD prices are subject to change without notice. Effective as of August 2023.

PROFILE B46

B46-9100-00-xx

ROUGH & TRIM PACKAGE

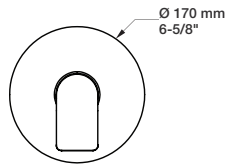

CC	KK	LL	BB	NN/YY	VV/TT	GG
645	746	813	813	746	846	1047

Complete pressure balanced shower control valve

- A- 6 gpm - 60 psi
- B- Volume control valve
- C- CAR-1020-40
- D- Rough valve RVA-9020-00-B included

TRIM ONLY

T46-9139-00-xx

CC	KK	LL	BB	NN/YY	VV/TT	GG
335	436	503	503	436	536	737

ROUGH VALVE Please order the following rough valve to complete the trim:

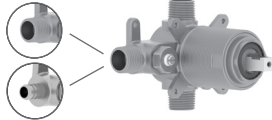

RVA-9020-00-B

Type P rough - 1/2" male NPT or welded copper connections

310

RVA-9020-PO-B

Type P rough - PEX connections

310

B46-9180-00-xx

ROUGH & TRIM PACKAGE

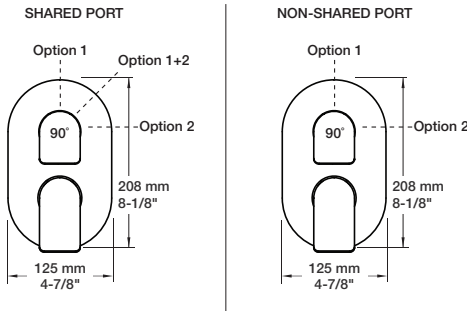

CC	KK	LL	BB	NN/YY	VV/TT	GG
841	951	1025	1025	951	1061	1281

Complete pressure balanced shower control valve with 2-way diverter (shared port)

- A- 1 outlet: 5 gpm - 60 psi, 2 outlets: 2.6 gpm - 60 psi
- B- Volume control valve
- C- Up to 2 accessories can be used at the same time
- D- Thin brass plate
- E- CAR-1020-40 (volume), CAR-1001-35 (diverter)
- F- Rough valve RVA-9181-00-B included

Ecological options CEC

Codes	Features
B46-9180-00-xx-NS	Non-shared port
T46-9180-00-xx + RVA-9181-00-NS-B	1 accessory works at a time
T46-9180-00-xx + RVA-9181-PO-NS-B	CAR-1001-35-NS (diverter)

TRIM ONLY

T46-9180-00-xx

CC	KK	LL	BB	NN/YY	VV/TT	GG
367	477	551	551	477	587	807

ROUGH VALVES Please order **one** of the following rough valves to complete the trim:

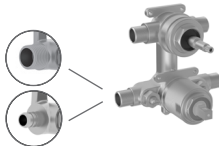

RVA-9181-00-B

2-way type P rough - 1/2" male NPT or welded copper connections

474

RVA-9181-PO-B

2-way type P rough - PEX connections

474

B46-9404-00-xx

ROUGH & TRIM PACKAGE

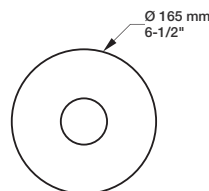

CC	KK	LL	BB	NN/YY	VV/TT	GG
1199	1354	1458	1458	1354	1509	1819

Complete 3/4" thermostatic valve

- A- 16 gpm - 60 psi
- B- Separate volume control or diverter valve required
- C- Can easily supply 3 accessories
- D- Thin brass plate
- E- CAR-3404-00
- F- Rough valve RVA-3404-00-B included
- G- Reversible check / non-return valves in case of water supply inversion

TRIM ONLY

T46-9404-00-xx

CC	KK	LL	BB	NN/YY	VV/TT	GG
517	672	776	776	672	827	1137

ROUGH VALVE Please order the following rough valve to complete the trim:



RVA-3404-00-B

Type T rough - 3/4" female NPT connections

682

Finishes:

CC = chrome, KK = matte black, LL = satin brass, BB = white, NN = brushed nickel, YY = polished nickel, TT = venetian bronze, VV = satin copper, GG = gold 155

PROFILE B46

B46-9453-00-xx

ROUGH & TRIM PACKAGE

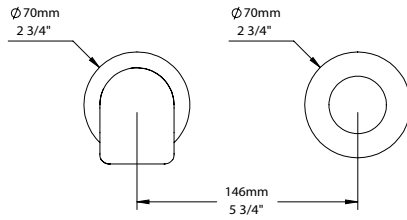

CC	KK	LL	BB	NN/YY	VV/TT	GG
1166	1321	1425	1425	1321	1476	1786

Complete 3/4" thermostatic valve

- A- 9 gpm - 60 psi
- B- Separate volume control or diverter valve required
- C- Can easily supply 3 accessories
- D- Hook on the side of the valve can be removed to give access to the check valves
- E- Reversible check / non-return valves in case of water supply inversion
- F- CAR-2661-00
- G- Rough valve RVA-3453-00-B included
- H- Large depth adjustment range

TRIM ONLY

T46-9453-00-xx

CC	KK	LL	BB	NN/YY	VV/TT	GG
517	672	776	776	672	827	1137

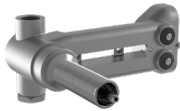

ROUGH VALVE Please order the following rough valve to complete the trim:

RVA-3453-00-B

Type T rough - 3/4" female NPT connections

649

B46-9521-00-xx

ROUGH & TRIM PACKAGE

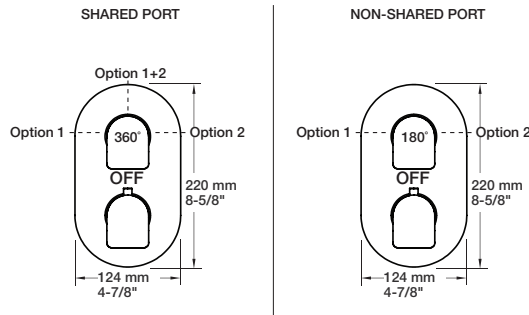

CC	KK	LL	BB	NN/YY	VV/TT	GG
1118	1248	1335	1335	1248	1378	1638

Complete thermostatic pressure balanced shower control valve with 2-way diverter (shared port)

- A- 1 outlet: 7.9 gpm - 60 psi, 2 outlets: 3.7 gpm - 60 psi
- B- Up to 2 accessories can be used at the same time
- C- Thin brass plate
- D- Reversible check / non-return valves in case of water supply inversion
- E- CAR-2661-00 (temperature), CAR-3003-36 (diverter)
- F- Rough valve RVA-9521-00-B included
- G- Large depth adjustment range

Ecological options CEC

Codes	Features
B46-9521-00-xx-NS	Non-shared port
T46-9521-00-xx + RVA-9521-00-NS-B	1 accessory works at a time
T46-9521-00-xx + RVA-9521-PO-NS-B	CAR-3003-36-NS (diverter)

TRIM ONLY

T46-9521-00-xx

CC	KK	LL	BB	NN/YY	VV/TT	GG
433	563	650	650	563	693	953

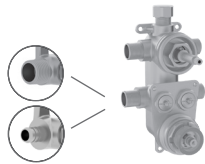

ROUGH VALVES Please order **one** of the following rough valves to complete the trim:

RVA-9521-00-B

2-way TP rough - 1/2" male NPT or welded copper connections

685

RVA-9521-PO-B

2-way TP rough - PEX connections

685

Actual products may differ from pictures. Actual products measures may differ from the measures shown. All USD prices are subject to change without notice. Effective as of August 2023.

PROFILE B46

B46-9531-00-xx

ROUGH & TRIM PACKAGE

CC	KK	LL	BB	NN/YY	VV/TT	GG
1228	1358	1445	1445	1358	1488	1748

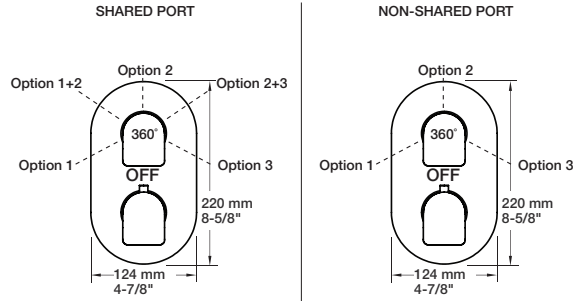

Complete thermostatic pressure balanced shower control valve with 3-way diverter (shared port)

- A- 1 outlet: 7.9 gpm - 60 psi, 2 outlets: 3.7 gpm - 60 psi
- B- Up to 2 accessories can be used at the same time
- C- Thin brass plate
- D- Reversible check / non-return valves in case of water supply inversion
- E- CAR-2661-00 (temperature), CAR-9531-03 (diverter)
- F- Rough valve RVA-9531-00-B included
- G- Large depth adjustment range

Ecological options CEC

Codes	Features
B46-9531-00-xx-NS	Non-shared port
T46-9531-00-xx + RVA-9531-00-NS-B	1 accessory works at a time
T46-9531-00-xx + RVA-9531-PO-NS-B	CAR-9531-03-NS (diverter)

TRIM ONLY

T46-9531-00-xx

CC	KK	LL	BB	NN/YY	VV/TT	GG
433	563	650	650	563	693	953

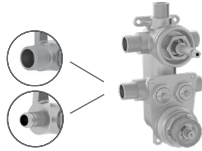

ROUGH VALVES Please order **one** of the following rough valves to complete the trim:

RVA-9531-00-B	3-way TP rough - 1/2" male NPT or welded copper connections	795
RVA-9531-PO-B	3-way TP rough - PEX connections	795

B46-9560-02-xx

ROUGH & TRIM PACKAGE

CC	KK	LL	BB	NN/YY	VV/TT	GG
513	577	620	620	577	641	770

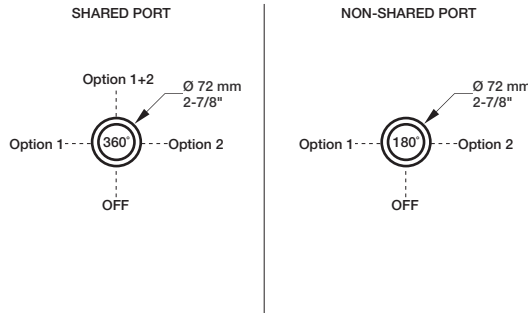

Complete 2-port diverter with stop (shared port)

- A- 1 outlet: 10.5 gpm - 60 psi, 2 outlets: 4 gpm - 60 psi
- B- Can replace 2 volume control valves
- C- Up to 2 accessories can be used at the same time
- D- CAR-9525-02
- E- Rough RVA-9562-00-B included
- F- Extra long cartridge for maximum adjustment

Ecological options CEC

Codes	Features
B46-9560-02-xx-NS	Non-shared port
T46-9560-02-xx + RVA-9562-00-NS-B	1 accessory works at a time
	CAR-9525-02-NS (diverter)

TRIM ONLY

T46-9560-02-xx

CC	KK	LL	BB	NN/YY	VV/TT	GG
214	278	321	321	278	342	471



ROUGH VALVE Please order the following rough valve to complete the trim:

RVA-9562-00-B	2-port diverter rough - 1/2" male NPT or welded copper connections	299
----------------------	--------------------------------------------------------------------	------------

Finishes:

CC = chrome, KK = matte black, LL = satin brass, BB = white, NN = brushed nickel, YY = polished nickel, TT = venetian bronze, VV = satin copper, GG = gold **157**

PROFILE B46

B46-9560-03-xx

ROUGH & TRIM PACKAGE

CC	KK	LL	BB	NN/YY	VV/TT	GG
595	659	702	702	659	723	852

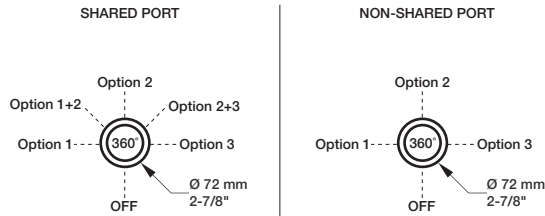

Complete 3-port diverter with stop (shared port)

- A- 1 outlet: 9.7 gpm - 60 psi, 2 outlets: 5.2 gpm - 60 psi
- B- Can replace 2 or 3 volume control valves
- C- Up to 2 accessories can be used at the same time
- D- CAR-9530-03
- E- Rough RVA-9563-00-B included
- F- Extra long cartridge for maximum adjustment

Ecological options CEC

Codes	Features
B46-9560-03-xx-NS	Non-shared port
T46-9560-03-xx + RVA-9563-00-NS-B	1 accessory works at a time CAR-9530-03-NS (diverter)

TRIM ONLY



T46-9560-03-xx

CC	KK	LL	BB	NN/YY	VV/TT	GG
214	278	321	321	278	342	471

ROUGH VALVE Please order the following rough valve to complete the trim:

RVA-9563-00-B

3-port diverter rough - inlet: 3/4" F NPT - outlets: 1/2" F NPT

381

B46-9649-00-xx

ROUGH & TRIM PACKAGE

CC	KK	LL	BB	NN/YY	VV/TT	GG
449	513	556	556	513	577	706

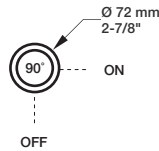

Complete 3/4" volume control valve

- A- 11.1 gpm - 60 psi
- B- Volume control valve
- C- Offers a larger flow
- D- CAR-2719-34
- E- Rough valve RVA-2719-34-B included
- F- Extra long cartridge for maximum adjustment

TRIM ONLY



T46-9649-00-xx

CC	KK	LL	BB	NN/YY	VV/TT	GG
214	278	321	321	278	342	471

ROUGH VALVE Please order the following rough valve to complete the trim:

RVA-2719-34-B

Volume control valve rough - 3/4" female NPT connections



















235

Actual products may differ from pictures. Actual products measures may differ from the measures shown. All USD prices are subject to change without notice. Effective as of August 2023.

PROFILE B46

SELECTION OF SHOWER COMPONENTS

For more shower components and for ecological options, please refer to the shower components section (see p. 347-382).

TET-0810-01-xx 8" round shower head  <table border="1"> <thead> <tr> <th>CC</th> <th>KK</th> <th>LL</th> <th>BB</th> </tr> </thead> <tbody> <tr> <td>445</td> <td>579</td> <td>668</td> <td>668</td> </tr> </tbody> </table>	CC	KK	LL	BB	445	579	668	668	TET-1010-01-xx 10" round shower head  <table border="1"> <thead> <tr> <th>CC</th> <th>KK</th> <th>LL</th> <th>BB</th> </tr> </thead> <tbody> <tr> <td>575</td> <td>748</td> <td>863</td> <td>863</td> </tr> </tbody> </table>	CC	KK	LL	BB	575	748	863	863	TET-1213-01-xx 12" round shower head  <table border="1"> <thead> <tr> <th>CC</th> </tr> </thead> <tbody> <tr> <td>572</td> </tr> </tbody> </table>	CC	572	TET-1208-01-xx 12" x 8" rectangular shower head  <table border="1"> <thead> <tr> <th>CC</th> <th>KK</th> </tr> </thead> <tbody> <tr> <td>462</td> <td>601</td> </tr> </tbody> </table>	CC	KK	462	601	BRA-1409-02-xx 15" L-shaped shower arm  <table border="1"> <thead> <tr> <th>CC</th> <th>KK</th> <th>LL</th> <th>BB</th> </tr> </thead> <tbody> <tr> <td>314</td> <td>408</td> <td>471</td> <td>471</td> </tr> </tbody> </table>	CC	KK	LL	BB	314	408	471	471										
CC	KK	LL	BB																																									
445	579	668	668																																									
CC	KK	LL	BB																																									
575	748	863	863																																									
CC																																												
572																																												
CC	KK																																											
462	601																																											
CC	KK	LL	BB																																									
314	408	471	471																																									
TET-0813-01-xx 8" round shower head  <table border="1"> <thead> <tr> <th>CC</th> </tr> </thead> <tbody> <tr> <td>310</td> </tr> </tbody> </table>	CC	310	TET-1013-01-xx 10" round shower head  <table border="1"> <thead> <tr> <th>CC</th> <th>KK</th> </tr> </thead> <tbody> <tr> <td>416</td> <td>541</td> </tr> </tbody> </table>	CC	KK	416	541	TET-1613-01-xx 16" round shower head  <table border="1"> <thead> <tr> <th>CC</th> </tr> </thead> <tbody> <tr> <td>809</td> </tr> </tbody> </table>	CC	809	TET-1614-91-xx 16" square built-in shower head  <table border="1"> <thead> <tr> <th>CC</th> </tr> </thead> <tbody> <tr> <td>1006</td> </tr> </tbody> </table>	CC	1006	BRA-1612-66-xx 16" shower arm  <table border="1"> <thead> <tr> <th>CC</th> <th>KK</th> <th>LL</th> <th>BB</th> </tr> </thead> <tbody> <tr> <td>179</td> <td>233</td> <td>269</td> <td>269</td> </tr> </tbody> </table>	CC	KK	LL	BB	179	233	269	269																						
CC																																												
310																																												
CC	KK																																											
416	541																																											
CC																																												
809																																												
CC																																												
1006																																												
CC	KK	LL	BB																																									
179	233	269	269																																									
				BRA-1815-02-xx 18" shower arm  <table border="1"> <thead> <tr> <th>CC</th> <th>KK</th> <th>LL</th> <th>BB</th> </tr> </thead> <tbody> <tr> <td>325</td> <td>423</td> <td>488</td> <td>488</td> </tr> </tbody> </table>	CC	KK	LL	BB	325	423	488	488																																
CC	KK	LL	BB																																									
325	423	488	488																																									
DGL-2070-57-xx 3-spray sliding shower bar  <table border="1"> <thead> <tr> <th>CC</th> <th>KK</th> <th>LL</th> <th>BB</th> </tr> </thead> <tbody> <tr> <td>594</td> <td>772</td> <td>891</td> <td>891</td> </tr> </tbody> </table>	CC	KK	LL	BB	594	772	891	891	DGL-2580-53-xx 3-spray sliding shower bar  <table border="1"> <thead> <tr> <th>CC</th> <th>KK</th> <th>LL</th> <th>BB</th> </tr> </thead> <tbody> <tr> <td>594</td> <td>772</td> <td>891</td> <td>891</td> </tr> </tbody> </table>	CC	KK	LL	BB	594	772	891	891	DGL-3080-73-xx 3-spray sliding shower bar  <table border="1"> <thead> <tr> <th>CC</th> <th>KK</th> <th>LL</th> <th>BB</th> </tr> </thead> <tbody> <tr> <td>749</td> <td>974</td> <td>1124</td> <td>1124</td> </tr> </tbody> </table>	CC	KK	LL	BB	749	974	1124	1124	DGL-3097-73-xx Shower column with hand shower, head not included  <table border="1"> <thead> <tr> <th>CC</th> <th>KK</th> <th>LL</th> <th>BB</th> </tr> </thead> <tbody> <tr> <td>999</td> <td>1299</td> <td>1499</td> <td>1499</td> </tr> </tbody> </table>	CC	KK	LL	BB	999	1299	1499	1499	RAC-0618-02-xx 6" ceiling mount shower arm  <table border="1"> <thead> <tr> <th>CC</th> <th>KK</th> <th>LL</th> <th>BB</th> </tr> </thead> <tbody> <tr> <td>68</td> <td>88</td> <td>102</td> <td>102</td> </tr> </tbody> </table>	CC	KK	LL	BB	68	88	102	102
CC	KK	LL	BB																																									
594	772	891	891																																									
CC	KK	LL	BB																																									
594	772	891	891																																									
CC	KK	LL	BB																																									
749	974	1124	1124																																									
CC	KK	LL	BB																																									
999	1299	1499	1499																																									
CC	KK	LL	BB																																									
68	88	102	102																																									
				RAC-9001-16-xx 1/2" F wall-mount supply elbow  <table border="1"> <thead> <tr> <th>CC</th> <th>KK</th> <th>LL</th> <th>BB</th> </tr> </thead> <tbody> <tr> <td>124</td> <td>161</td> <td>186</td> <td>186</td> </tr> </tbody> </table>	CC	KK	LL	BB	124	161	186	186																																
CC	KK	LL	BB																																									
124	161	186	186																																									
BEC-0520-46-xx Profile tub spout without diverter  <table border="1"> <thead> <tr> <th>CC</th> <th>KK</th> <th>LL</th> <th>BB</th> </tr> </thead> <tbody> <tr> <td>434</td> <td>564</td> <td>651</td> <td>651</td> </tr> </tbody> </table>	CC	KK	LL	BB	434	564	651	651	BEC-0520-73-xx 7" round tub spout without diverter  <table border="1"> <thead> <tr> <th>CC</th> <th>KK</th> <th>LL</th> <th>BB</th> </tr> </thead> <tbody> <tr> <td>168</td> <td>218</td> <td>252</td> <td>252</td> </tr> </tbody> </table>	CC	KK	LL	BB	168	218	252	252	BEC-0520-74-xx 7" round tub spout with diverter  <table border="1"> <thead> <tr> <th>CC</th> <th>KK</th> <th>LL</th> <th>BB</th> </tr> </thead> <tbody> <tr> <td>198</td> <td>257</td> <td>297</td> <td>297</td> </tr> </tbody> </table>	CC	KK	LL	BB	198	257	297	297	BOD-5002-01-xx Cylindrical lateral body jet  <table border="1"> <thead> <tr> <th>CC</th> <th>KK</th> <th>LL</th> <th>BB</th> </tr> </thead> <tbody> <tr> <td>199</td> <td>259</td> <td>299</td> <td>299</td> </tr> </tbody> </table>	CC	KK	LL	BB	199	259	299	299	BOD-5007-01-xx Round built-in lateral body jet  <table border="1"> <thead> <tr> <th>CC</th> <th>KK</th> <th>LL</th> <th>BB</th> </tr> </thead> <tbody> <tr> <td>325</td> <td>423</td> <td>488</td> <td>488</td> </tr> </tbody> </table>	CC	KK	LL	BB	325	423	488	488
CC	KK	LL	BB																																									
434	564	651	651																																									
CC	KK	LL	BB																																									
168	218	252	252																																									
CC	KK	LL	BB																																									
198	257	297	297																																									
CC	KK	LL	BB																																									
199	259	299	299																																									
CC	KK	LL	BB																																									
325	423	488	488																																									

Actual products may differ from pictures. Actual products measures may differ from the measures shown. All USD prices are subject to change without notice. Effective as of August 2023.

COMPLETE SHOWER KITS

PRO-1100-53-xx



Complete thermostatic shower kit on column

CC	KK	LL	BB	NN/YY	VV/TT	GG
1775	2308	2663	2663	2308	2840	3905

Features

- A- Max: 2 gpm - 80 psi (per accessory)
- B- 3-spray push-button hand shower
- C- 2 accessories can work together
- D- Temperature handle on the hot water inlet side, allowing the surface temperature to never exceed the shower water temperature
- E- Shower head arm adjustable up to 20" in height
- F- Easy to move metal slider with built-in hook
- G- Thermostatic cartridge: CAR-2661-00
- H- Diverter cartridge: CAR-3003-36

Ecological options	Code	Features are the same, except:
CEC	PRO-1100-53-xx-NS	A- Max: 1.75 gpm - 80 psi (per accessory) C- 1 accessory works at a time H- Diverter cartridge: CAR-3003-36-NS

PRO-2815-46-xx

PRR-2815-46-xx*



Complete pressure balanced shower kit

CC	KK
1595	2074

Features

- A- 2 accessories kit
- B- Max: 2 gpm - 80 psi (per accessory)
- C- 3-spray hand shower
- D- 2 accessories can work together

Includes

- B46-9180-00-xx** Complete type P valve with 2-way diverter
- TET-1013-01-xx** 10" round shower head
- BRA-1612-66-xx** 16" shower arm
- DGL-2580-53-xx** 3-spray sliding shower bar
- RAC-9001-26-xx** Wall-mount supply elbow

Ecological options	Codes	Features are the same, except:
CEC	PRO-2815-46-xx-NS	B- Max: 1.75 gpm - 80 psi (per accessory)
	TRO-2815-46-xx-NS + RVA-9181-00-NS-B	D- 1 accessory works at a time

TRIM ONLY

TRO-2815-46-xx	CC	KK
TRR-2815-46-xx*	1121	1600

ROUGH VALVES Please order **one** of the following rough valves to complete the trim:

RVA-9181-00-B	2-way type P rough - 1/2" male NPT or welded copper connections	474
RVA-9181-PO-B	2-way type P rough - PEX connections	474

PRO-2896-46-xx

PRR-2896-46-xx*



Complete pressure balanced shower kit

CC	KK	LL	BB	NN/YY	VV/TT	GG
1595	2074	2393	2393	2074	2552	3509

Features

- A- 2 accessories kit
- B- Max: 2 gpm - 80 psi (per accessory)
- C- 1-spray hand shower
- D- 2 accessories can work together

Includes

- B46-9180-00-xx** Complete pressure balanced valve with 2-way diverter
- TET-0810-01-xx** 10" round shower head
- BRA-1612-66-xx** 16" shower arm
- DSP-2604-19-xx** Hand shower on wall-mounted supply elbow

Ecological options	Codes	Features are the same, except:
CEC	PRO-2896-46-xx-NS	B- Max: 1.75 gpm - 80 psi (per accessory)
	TRO-2896-46-xx-NS + RVA-9181-00-NS-B	D- 1 accessory works at a time

TRIM ONLY

TRO-2896-46-xx	CC	KK	LL	BB	NN/YY	VV/TT	GG
TRR-2896-46-xx*	1121	1600	1919	1919	1600	2078	3035

ROUGH VALVES Please order **one** of the following rough valves to complete the trim:

RVA-9181-00-B	2-way type P rough - 1/2" male NPT or welded copper connections	474
RVA-9181-PO-B	2-way type P rough - PEX connections	474

Finishes:

CC = chrome, KK = matte black, LL = satin brass, BB = white, NN = brushed nickel, YY = polished nickel, TT = venetian bronze, VV = satin copper, GG = gold

* With 6" ceiling mount shower arm

PROFILE B46

PRO-3302-46-xx PRR-3302-46-xx*

Complete thermostatic shower kit

CC	KK	LL	BB	NN/YY	VV/TT	GG
2295	2984	3443	3443	2984	3672	5049

Features

- A- 2 accessories kit
- B- Max: 2 gpm - 80 psi (per accessory)
- C- 1-spray hand shower
- D- 2 accessories can work together
- E- Hook as part of the thermostatic valve trim

Includes

- B46-9453-00-xx** Complete 3/4" thermostatic valve
- B46-9560-02-xx** Complete 2-port diverter with off
- TET-1010-01-xx** 8" rounded square shower head
- BRA-1612-66-xx** 16" shower arm
- DSP-2604-19-xx** Hand shower on wall-mounted supply elbow

Ecological options CEC

Codes

PRO-3302-46-xx-NS
TRO-3302-46-xx-NS + RVA-3453-00-B +
RVA-9562-00-NS-B

Features are the same, except:

- B- Max: 1.75 gpm - 80 psi (per accessory)
- D- 1 accessory works at a time

TRIM ONLY

TRO-3302-46-xx TRR-3302-46-xx*

CC	KK	LL	BB	NN/YY	VV/TT	GG
1347	2036	2495	2495	2036	2724	4101

ROUGH VALVES Please order **all** of the following rough valves to complete the trim:

RVA-3453-00-B	Type T rough - 3/4" female NPT connections	649
----------------------	--------------------------------------------	------------

RVA-9562-00-B	2-port diverter rough - 1/2" male NPT or welded copper connections	299
----------------------	--------------------------------------------------------------------	------------

PRO-3950-46-xx PRR-3950-46-xx*

Complete thermostatic shower kit

CC	KK	LL	BB	NN/YY	VV/TT	GG
4285	5571	6428	6428	5571	6856	9427

Features

- A- 3 accessories kit
- B- Max: 2 gpm - 80 psi (per accessory)
- C- 3-spray hand shower
- D- 59" PVC hose in CC and KK finishes or brass for other finishes
- E- 3 accessories can work together

Includes

- B46-9404-00-xx** Complete 3/4" thermostatic valve
- B46-9649-00-xx** Complete 3/4" shut-off valve (3)
- TET-1010-01-xx** 8" round shower head
- BRA-1612-66-xx** 16" shower arm
- DGL-3080-73-xx** 3-spray sliding shower bar
- RAC-9001-16-xx** Wall-mount supply elbow
- BOD-5007-01-xx** Built-in body jets (3)

TRIM ONLY

TRO-3950-46-xx TRR-3950-46-xx*

CC	KK	LL	BB	NN/YY	VV/TT	GG
2898	4184	5041	5041	4184	5469	8040

ROUGH VALVES Please order **all** of the following rough valves to complete the trim:

1x RVA-3404-00-B	Type T rough - 3/4" female NPT connections	682
-------------------------	--------------------------------------------	------------

3x RVA-2719-34-B	Volume control valve rough - 3/4" female NPT connections	235
-------------------------	----------------------------------------------------------	------------

PRO-4206-46-xx PRR-4206-46-xx*

Complete thermostatic pressure balanced shower kit

CC	KK	LL	BB	NN/YY	VV/TT	GG
2135	2776	3203	3203	2776	3416	4697

Features

- A- 2 accessories kit
- B- Max: 2 gpm - 80 psi (per accessory)
- C- 3-spray hand shower
- D- 59" PVC hose in CC and KK finishes or brass for other finishes
- E- 2 accessories can work together

Includes

- B46-9521-00-xx** Complete TP shower control valve with 2-way diverter
- TET-0810-01-xx** 8" round shower head
- BRA-1612-66-xx** 16" shower arm
- DGL-3080-73-xx** 3-spray sliding shower bar
- RAC-9001-16-xx** Wall-mount supply elbow

Ecological options CEC

Codes

PRO-4206-46-xx-NS
TRO-4206-46-xx-NS + RVA-9521-00-NS-B

Features are the same, except:

- B- Max: 1.75 gpm - 80 psi (per accessory)
- E- 1 accessory works at a time

TRIM ONLY

TRO-4206-46-xx TRR-4206-46-xx*

CC	KK	LL	BB	NN/YY	VV/TT	GG
1450	2091	2518	2518	2091	2731	4012

ROUGH VALVES Please order **one** of the following rough valves to complete the trim:

RVA-9521-00-B	2-way TP rough - 1/2" male NPT or welded copper connections	685
----------------------	-------------------------------------------------------------	------------

RVA-9521-PO-B	2-way TP rough - PEX connections	685
----------------------	----------------------------------	------------

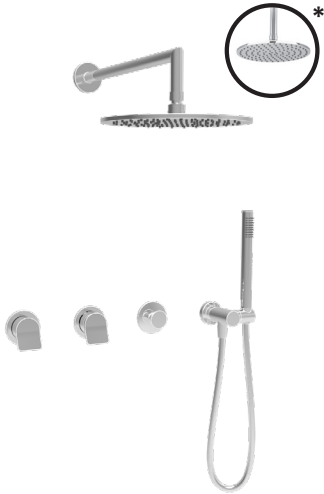

Actual products may differ from pictures. Actual products measures may differ from the measures shown. All USD prices are subject to change without notice. Effective as of August 2023.

PROFILE B46

PRO-4216-46-xx PRR-4216-46-xx*

Complete thermostatic pressure balanced shower kit

CC

2032



Features

- A- 2 accessories kit
- B- Max: 2 gpm - 80 psi (per accessory)
- C- 3-spray hand shower
- D- 2 accessories can work together

Includes

- B46-9521-00-xx** Complete TP shower control valve with 2-way diverter
- TET-1213-01-xx** 12" round shower head
- BRA-1612-66-xx** 16" shower arm
- DGL-2580-53-xx** 3-spray sliding shower bar
- RAC-9001-26-xx** Wall-mount supply elbow

Ecological options CEC

Codes

PRO-4216-46-xx-NS
TRO-4216-46-xx-NS + RVA-9521-00-NS-B

Features are the same, except:

B- Max: 1.75 gpm - 80 psi (per accessory)
D- 1 accessory works at a time

TRIM ONLY

TRO-4216-46-xx
TRR-4216-46-xx*

CC

1347

ROUGH VALVES Please order **one** of the following rough valves to complete the trim:

RVA-9521-00-B

2-way TP rough - 1/2" male NPT or welded copper connections

685

RVA-9521-PO-B

2-way TP rough - PEX connections

685

PRO-4226-46-xx PRR-4226-46-xx*

Complete thermostatic pressure balanced shower kit

CC	KK	LL	BB	NN/YY	VV/TT	GG
2265	2945	3398	3398	2945	3624	4983



Features

- A- 2 accessories kit
- B- Max: 2 gpm - 80 psi (per accessory)
- C- 3-spray hand shower
- D- 59" PVC hose in CC and KK finishes or brass for other finishes
- E- 2 accessories can work together

Includes

- B46-9521-00-xx** Complete TP shower control valve with 2-way diverter
- TET-1010-01-xx** 10" round shower head
- BRA-1409-02-xx** 15" L-shaped shower arm
- DGL-3080-73-xx** Profile 3-spray sliding shower bar
- RAC-9001-16-xx** Wall-mount supply elbow

Ecological options CEC

Codes

PRO-4226-46-xx-NS
TRO-4226-46-xx-NS + RVA-9521-00-NS-B

Features are the same, except:

B- Max: 1.75 gpm - 80 psi (per accessory)
E- 1 accessory works at a time

TRIM ONLY

TRO-4226-46-xx
TRR-4226-46-xx*

CC	KK	LL	BB	NN/YY	VV/TT	GG
1580	2260	2713	2713	2260	2939	4298

ROUGH VALVES Please order **one** of the following rough valves to complete the trim:

RVA-9521-00-B

2-way TP rough - 1/2" male NPT or welded copper connections

685

RVA-9521-PO-B

2-way TP rough - PEX connections

685

PRO-4236-46-xx

Complete thermostatic pressure balanced shower kit

CC	KK	LL	BB	NN/YY	VV/TT	GG
2440	3172	3660	3660	3172	3904	5368



Features

- A- 2 accessories kit
- B- Max: 2 gpm - 80 psi (per accessory)
- C- 3-spray hand shower
- D- 2 accessories can work together

Includes

- B46-9521-00-xx** Complete TP shower control valve with 2-way diverter
- TET-1010-01-xx** 10" round shower head
- DGL-3097-73-xx** Shower column with 3-spray hand shower
- RAC-9001-16-xx** Wall-mount supply elbow

Ecological options CEC

Codes

PRO-4236-46-xx-NS
TRO-4236-46-xx-NS + RVA-9521-00-NS-B

Features are the same, except:

B- Max: 1.75 gpm - 80 psi (per accessory)
D- 1 accessory works at a time

TRIM ONLY

TRO-4236-46-xx

CC	KK	LL	BB	NN/YY	VV/TT	GG
1755	2487	2975	2975	2487	3219	4683

ROUGH VALVES Please order **one** of the following rough valves to complete the trim:

RVA-9521-00-B

2-way TP rough - 1/2" male NPT or welded copper connections

685

RVA-9521-PO-B

2-way TP rough - PEX connections

685

Finishes:

CC = chrome, KK = matte black, LL = satin brass, BB = white, NN = brushed nickel, YY = polished nickel, TT = venetian bronze, VV = satin copper, GG = gold

* With 6" ceiling mount shower arm

PROFILE B46

PRO-4296-46-xx PRR-4296-46-xx*



Complete thermostatic pressure balanced shower kit

CC	KK	LL	BB	NN/YY	VV/TT	GG
1889	2456	2834	2834	2456	3022	4156

Features

- A- 2 accessories kit
- B- Max: 2 gpm - 80 psi (per accessory)
- C- 1-spray hand shower
- D- 2 accessories can work together

Includes

- B46-9521-00-xx** Complete pressure balanced valve with 2-way diverter
- TET-1010-01-xx** 8" round shower head
- BRA-1612-66-xx** 16" shower arm
- DSP-2604-19-xx** Hand shower on wall-mounted supply elbow

Ecological options CEC

Codes	Features are the same, except:
PRO-4296-46-xx-NS	B- Max: 1.75 gpm - 80 psi (per accessory)
TRO-4296-46-xx-NS + RVA-9521-00-NS-B	D- 1 accessory works at a time

TRIM ONLY

TRO-4296-46-xx TRR-4296-46-xx*

CC	KK	LL	BB	NN/YY	VV/TT	GG
1204	1771	2149	2149	1771	2337	3471

ROUGH VALVES Please order **one** of the following rough valves to complete the trim:

RVA-9521-00-B	2-way TP rough - 1/2" male NPT or welded copper connections	685
RVA-9521-P0-B	2-way TP rough - PEX connections	685

PRO-4306-46-xx PRR-4306-46-xx*



Complete thermostatic pressure balanced shower kit

CC	KK	LL	BB	NN/YY	VV/TT	GG
2619	3405	3929	3929	3405	4190	5762

Features

- A- 3 accessories kit
- B- 7.9 gpm - 60 psi (bath spout)
- C- Max: 2 gpm - 80 psi (shower accessories)
- D- 3-spray hand shower
- E- 59" PVC hose in CC and KK finishes or brass for other finishes
- F- 2 accessories can work together

Includes

- B46-9531-00-xx** Complete TP shower control valve with 3-way diverter
- BEC-0520-46-xx** Profile tub spout without diverter
- TET-0810-01-xx** 8" round shower head
- BRA-1612-66-xx** 16" shower arm
- DGL-3080-73-xx** 3-spray sliding shower bar
- RAC-9001-16-xx** Wall-mount supply elbow

Ecological options CEC

Codes	Features are the same, except:
PRO-4306-46-xx-NS	C- Max: 1.75 gpm - 80 psi (shower accessories)
TRO-4306-46-xx-NS + RVA-9531-00-NS-B	F- 1 accessory works at a time

TRIM ONLY

TRO-4306-46-xx TRR-4306-46-xx*

CC	KK	LL	BB	NN/YY	VV/TT	GG
1824	2610	3134	3134	2610	3395	4967

ROUGH VALVES Please order **one** of the following rough valves to complete the trim:

RVA-9531-00-B	3-way TP rough - 1/2" male NPT or welded copper connections	795
RVA-9531-P0-B	3-way TP rough - PEX connections	795

Actual products may differ from pictures. Actual products measures may differ from the measures shown. All USD prices are subject to change without notice. Effective as of August 2023.

PROFILE B46

SELECTION OF BATHROOM ACCESSORIES

For more bathroom accessories, please refer to the bathroom accessories section (see p. 293-306).

A46-1029-00-xx
PROFILE
 Wall-mounted toilet paper holder



CC	KK	LL	BB	NN/YY	VV/TT	GG
226	294	339	339	294	361	497

A46-1069-00-xx
PROFILE
 Bathrobe holder



CC	KK	LL	BB	NN/YY	VV/TT	GG
126	164	189	189	164	202	277

A46-6012-00-xx
PROFILE
 12" single towel bar

Available Q3 2023



CC	KK	LL	BB	NN/YY	VV/TT	GG
292	380	438	438	380	467	642

A46-6018-00-xx
PROFILE
 18" single towel bar



CC	KK	LL	BB	NN/YY	VV/TT	GG
322	419	483	483	419	515	708

A46-6024-00-xx
PROFILE
 24" single towel bar



CC	KK	LL	BB	NN/YY	VV/TT	GG
364	473	546	546	473	582	800

A46-6030-00-xx
PROFILE
 30" single towel bar



CC	KK	LL	BB	NN/YY	VV/TT	GG
439	570	658	658	570	702	965

A85-3179-00-xx
 Shower squeegee



CC
173

A85-9077-00-xx
 Corner basket



CC
248

Finishes:

CC = chrome, KK = matte black, LL = satin brass, BB = white, NN = brushed nickel, YY = polished nickel, TT = venetian bronze, VV = satin copper, GG = gold 165

PROFILE B46

FLORA B47

Compatible with the Touchless Sensor
Order ELE-2001-01-xx (p. 43)



reddot winner 2022



2022

Or
GRANDS PRIX
DU DESIGN



BARIL

FLORA B47

LEGEND

xx: Finish

The first x is the main finish of the faucet, including the handle cover and the spout — chrome in this example.

The second x is the color accent — smokey grey in this example.

The finish of this example is therefore CF: smokey chrome.

Order

The first letter designates the main finish. The x designates the color accent.

Prices vary depending on the main finish only.

B47-1349-00-xx



Main Finish

Complete list at the bottom of the page.

- C= Chrome
- K= Matte Black
- L= Satin Brass
- B= White
- N= Brushed Nickel
- Y= Polished Nickel
- V= Satin Copper
- T= Venetian Bronze
- G= Gold

Color Accent

Complete list at the bottom of the page.

- A= Matte Silver
- B= White
- C= Chrome
- F= Smokey
- N= brushed nickel
- K= Matte Black
- Q= Marble
- L= Satin Brass
- T= Venetian Bronze
- V= Satin Copper
- Y= Polished Nickel
- G= Gold
- W= Wood

Cx	Kx	Lx	Bx	Nx/Yx	Vx/Tx	Gx
1534	1994	2301	2301	1994	2454	3375

3-piece tub filler with hand shower

Bath spout:

A- 7.4 gpm - 60 psi

B- Tub spout with integrated push-button diverter

Hand shower:

C- Max: 2 gpm - 80 psi

D- Non-conductive brass hand shower

E- Easy-to-clean anti-limestone hand shower

F- DOU-2604-01-xx

G- CAR-1031-49

Ecological options

Codes	Reduced flow rates
B47-1349-00-xx-150	1.5 gpm (5.7 l/min) - 80 psi
B47-1349-00-xx-175	1.75 gpm (6.6 l/min) - 80 psi

CEC

B47-1080-1PL-xx

DRAIN INCLUDED 

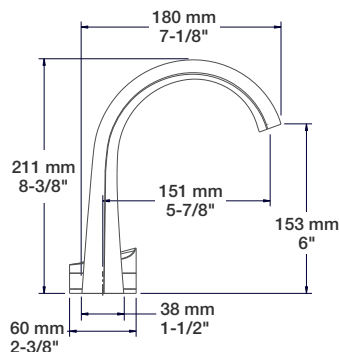

DRAIN NOT INCLUDED

B47-1080-00L-xx

G- Order your lavatory drain (pages 309-310)

Cx	Kx	Lx	Bx	Nx/Yx	Vx/Tx	Gx
1087	1413	1631	1631	1413	1739	2391

Single handle 2-piece lavatory faucet, drain included

A- 1.5 gpm - 60 psi

B- Adjustable aerator

C- Remote mixer controls temperature and flow

D- Adjustable widespread installation: 4" to 12" c/c

E- Spout flange included is optional

F- CAR-1031-49

G- Push-button drain with overflow included

Ecological options

Codes	Reduced flow rates
B47-1080-XXL-xx-120	1.2 gpm (4.5 l/min) - 60 psi
B47-1080-XXL-xx-100	1.0 gpm (3.7 l/min) - 60 psi
B47-1080-XXL-xx-050	0.5 gpm (1.9 l/min) - 60 psi

CEC

Cx	Kx	Lx	Bx	Nx/Yx	Vx/Tx	Gx
1039	1350	1559	1559	1350	1662	2280

FLORA B47

B47-8009-00L-xx

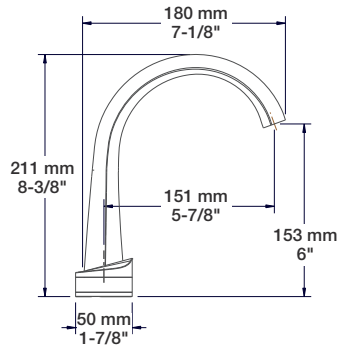

Cx	Kx	Lx	Bx	Nx/Yx	Vx/Tx	Gx
1248	1622	1872	1872	1622	1997	2746

8" c/c lavatory faucet, drain included

- A- Max: 1.5 gpm - 60 psi
- B- Push-button drain with overflow included
- C- Adjustable aerator
- D- Spout flange included is optional
- E- CAR-3820-01 (Cold), CAR-3820-02 (Hot)

Ecological options

Codes	Reduced flow rates	CEC
B47-8009-00L-xx-120	1.2 gpm (4.5 l/min) - 60 psi	
B47-8009-00L-xx-100	1.0 gpm (3.7 l/min) - 60 psi	
B47-8009-00L-xx-050	0.5 gpm (1.9 l/min) - 60 psi	

B47-8100-00L-xx

COMPLETE FAUCET

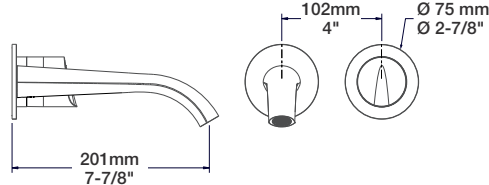

Cx	Kx	Lx	Bx	Nx/Yx	Vx/Tx	Gx
998	1297	1497	1497	1297	1597	2196

Single lever wall-mounted lavatory faucet, drain not included

- A- 1.5 gpm - 60 psi
- B- Order your lavatory drain (pages 309-310)
- C- Adjustable aerator
- D- One-piece rough for easy installation
- E- Large depth adjustment range
- F- CAR-1025-09

Ecological options

Codes	Reduced flow rates	CEC
B47-8100-00L-xx-120	1.2 gpm (4.5 l/min) - 60 psi	
B47-8100-00L-xx-100	1.0 gpm (3.7 l/min) - 60 psi	
B47-8100-00L-xx-050	0.5 gpm (1.9 l/min) - 60 psi	

TRIM ONLY

T47-8100-00L-xx

Cx	Kx	Lx	Bx	Nx/Yx	Vx/Tx	Gx
656	955	1155	1155	955	1255	1854

ROUGH Please order the following rough to complete the trim:

ROU-8147-04-B

Single lever wall-mounted lavatory rough - 1/2" male NPT or welded copper connections

342

B47-1100-00-xx

COMPLETE FAUCET

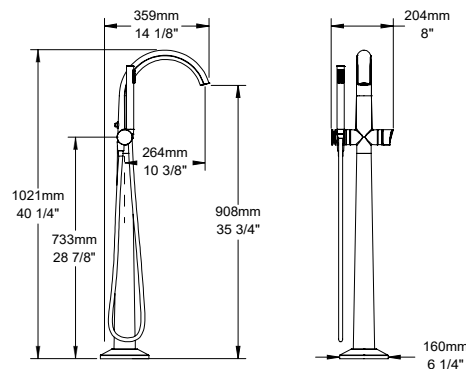

Cx	Kx	Lx	Bx	Nx/Yx	Vx/Tx	Gx
3640	4732	5460	5460	4732	5824	8008

Floor-mounted tub filler with hand shower

Bath spout:

- A- 7.1 gpm - 60 psi
- B- Tub spout with integrated push-button diverter

Hand shower:

- C- Max: 2 gpm - 80 psi
- D- Reclining hand shower holder
- E- Built-in hook on the hand shower holder
- F- Hand shower DOU-2604-01-xx
- G- 59" PVC hose in Kx finish or brass for other finishes
- H- CAR-1031-49

Ecological options

Codes	Reduced flow rates	CEC
B47-1100-00-xx-150	1.5 gpm (5.7 l/min) - 80 psi	
B47-1100-00-xx-175	1.75 gpm (6.6 l/min) - 80 psi	

TRIM ONLY

T47-1100-00-xx

Cx	Kx	Lx	Bx	Nx/Yx	Vx/Tx	Gx
3505	4597	5325	5325	4597	5689	7873

MOUNTING KIT Please order the following kit to complete the trim:

FIX-1100-00-B

Floor mounting kit for floor-mounted tub filler with hand shower

135

MAIN FINISHES (faucet body, flanges and handle covers):

C= chrome, N= brushed nickel, K= matte black, L= satin brass, B = white, Y= polished nickel T= venetian bronze, V= satin copper, , G= gold

SECONDARY FINISHES (color accent):

A= matte silver, B= white, C= chrome, F= smokey, G= gold, N= brushed nickel, K= matte black, Q= marble, W= wood, L= satin brass, T= venetian bronze, V= satin copper, Y= polished nickel

The products in this section are shown in smokey chrome (CF).

FLORA B47

B47-1349-00-xx

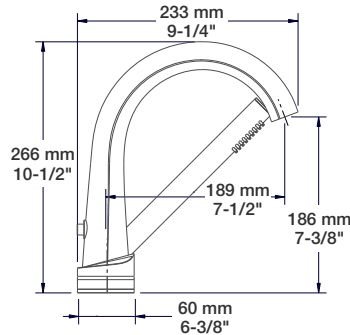

Cx	Kx	Lx	Bx	Nx/Yx	Vx/Tx	Gx
1534	1994	2301	2301	1994	2454	3375

3-piece tub filler with hand shower

Bath spout:

- A- 7.4 gpm - 60 psi
- B- Tub spout with integrated push-button diverter

Hand shower:

- C- Max: 2 gpm - 80 psi
- D- Non-conductive brass hand shower
- E- Easy-to-clean anti-limestone hand shower
- F- DOU-2604-01-xx
- G- CAR-1031-49

Ecological options

Codes	Reduced flow rates
B47-1349-00-xx-150	1.5 gpm (5.7 l/min) - 80 psi
B47-1349-00-xx-175	1.75 gpm (6.6 l/min) - 80 psi

B47-9453-00-xx



ROUGH & TRIM PACKAGE

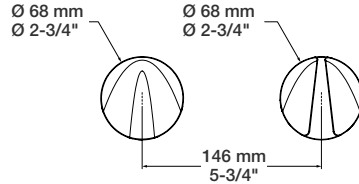

Cx	Kx	Lx	Bx	Nx/Yx	Vx/Tx	Gx
1248	1428	1548	1548	1428	1607	2147

Complete 3/4" thermostatic valve

- A- 9 gpm - 60 psi
- B- Separate volume control or diverter valve required
- C- Can easily supply 3 accessories
- D- Double hook on the side of the valve can be removed to give access to the check valves
- E- Reversible check / non-return valves in case of water supply inversion
- F- CAR-2661-00
- G- Rough valve RVA-3453-00-B included
- H- Large depth adjustment range
- I- Extra large Ø 3-1/2" round wall flange available; order ROS-9453-47-xx

TRIM ONLY

T47-9453-00-xx

Cx	Kx	Lx	Bx	Nx/Yx	Vx/Tx	Gx
599	779	899	899	779	958	1498

ROUGH VALVE Please order the following rough valve to complete the trim:

RVA-3453-00-B

Type T rough - 3/4" female NPT connections

649

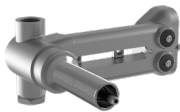

B47-9560-02-xx

ROUGH & TRIM PACKAGE

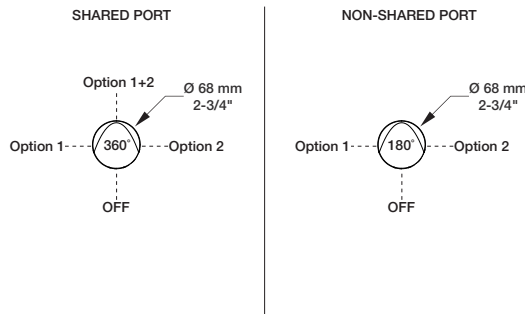

Cx	Kx	Lx	Bx	Nx/Yx	Vx/Tx	Gx
616	711	775	775	711	806	996

Complete 2-port diverter with stop (shared port)

- A- 1 outlet: 10.5 gpm - 60 psi, 2 outlets: 4 gpm - 60 psi
- B- Can replace 2 volume control valves
- C- Up to 2 accessories can be used at the same time
- D- CAR-9525-02
- E- Rough RVA-9562-00-B included
- F- Extra long cartridge for maximum adjustment
- G- Extra large Ø 3-1/2" round wall flange available; order ROS-9453-47-xx

Ecological options

Codes	Features
B47-9560-02-xx-NS	Non-shared port
T47-9560-02-xx + RVA-9562-00-NS-B	1 accessory works at a time
	CAR-9525-02-NS (diverter)

TRIM ONLY

T47-9560-02-xx

Cx	Kx	Lx	Bx	Nx/Yx	Vx/Tx	Gx
317	412	476	476	412	507	697

ROUGH VALVE Please order the following rough valve to complete the trim:

RVA-9562-00-B

2-port diverter rough - 1/2" male NPT or welded copper connections

299



FLORA B47

B47-9560-03-xx

ROUGH & TRIM PACKAGE

Cx	Kx	Lx	Bx	Nx/Yx	Vx/Tx	Gx
698	793	857	857	793	888	1078

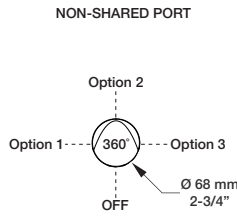
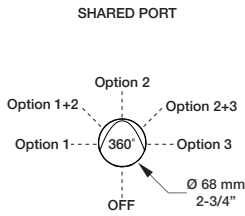

Complete 3-port diverter with stop (shared port)

- A- 1 outlet: 9.7 gpm - 60 psi, 2 outlets: 5.2 gpm - 60 psi
- B- Can replace 2 or 3 volume control valves
- C- Up to 2 accessories can be used at the same time
- D- CAR-9530-03
- E- Rough RVA-9563-00-B included
- F- Extra long cartridge for maximum adjustment
- G- Extra large Ø 3-1/2" round wall flange available; order ROS-9453-47-xx

Ecological options CEC

Codes	Features
B47-9560-03-xx-NS	Non-shared port
T47-9560-03-xx + RVA-9563-00-NS-B	1 accessory works at a time CAR-9530-03-NS (diverter)

TRIM ONLY



T47-9560-03-xx

Cx	Kx	Lx	Bx	Nx/Yx	Vx/Tx	Gx
317	412	476	476	412	507	697

ROUGH VALVE Please order the following rough valve to complete the trim:

RVA-9563-00-B

Brut de dérivateur 3 voies - entrée : 3/4" F NPT - sorties : 1/2" F NPT

381

B47-9600-00-xx

ROUGH & TRIM PACKAGE

Cx	Kx	Lx	Bx	Nx/Yx	Vx/Tx	Gx
491	586	650	650	586	681	871

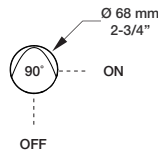

Complete 1/2" volume control valve

- A- 7.9 gpm - 60 psi
- B- Volume control valve
- C- CAR-1011-81
- D- Rough valve RVA-2020-01-B included
- E- Extra long cartridge for maximum adjustment
- F- Extra large Ø 3-1/2" round wall flange available; order ROS-9453-47-xx

TRIM ONLY



T47-9600-00-xx

Cx	Kx	Lx	Bx	Nx/Yx	Vx/Tx	Gx
317	412	476	476	412	507	697

ROUGH VALVE Please order the following rough valve to complete the trim:

RVA-2020-01-B

3-port diverter rough - inlet: 3/4" F NPT - outlets: 1/2" F NPT

174

B47-9649-00-xx

ROUGH & TRIM PACKAGE

Cx	Kx	Lx	Bx	Nx/Yx	Vx/Tx	Gx
552	647	711	711	647	742	932

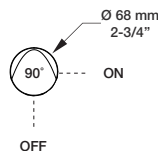

Complete 3/4" volume control valve

- A- 11.1 gpm - 60 psi
- B- Volume control valve
- C- Offers higher flow
- D- CAR-2719-34
- E- Rough valve RVA-2719-34-B included
- F- Extra long cartridge for maximum adjustment
- G- Extra large Ø 3-1/2" round wall flange available; order ROS-9453-47-xx

TRIM ONLY



T47-9649-00-xx

Cx	Kx	Lx	Bx	Nx/Yx	Vx/Tx	Gx
317	412	476	476	412	507	697

ROUGH VALVE Please order the following rough valve to complete the trim:

RVA-2719-34-B

Volume control valve rough - 3/4" female NPT connections

235

MAIN FINISHES (faucet body, flanges and handle covers):

C= chrome, N= brushed nickel, K= matte black, L= satin brass, B= white, Y= polished nickel T= venetian bronze, V= satin copper, G= gold

SECONDARY FINISHES (color accent):

A= matte silver, B= white, C= chrome, F= smokey, G= gold, N= brushed nickel, K= matte black, Q= marble, W= wood, L= satin brass, T= venetian bronze, V= satin copper, Y= polished nickel

The products in this section are shown in smokey chrome (CF).

FLORA B47

ROS-9453-47-xx

CC	KK	LL	BB	NN/YY	VV/TT	GG
65	85	98	98	85	104	143

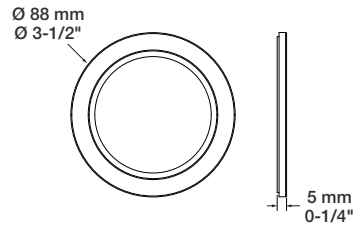

Extra large round wall flange $\text{Ø } 3\text{-}1/2\text{'}$













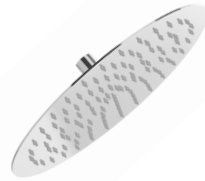



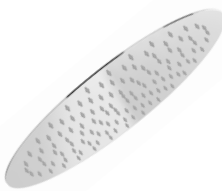
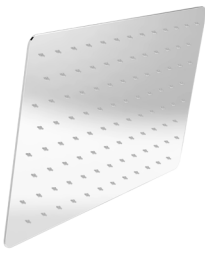



A- $3\text{-}1/2\text{'}$ outer diameter flange

B- Extra large diameter to cover gaps, holes and damage on wall

FLORA B47

SELECTION OF SHOWER COMPONENTS

For more shower components and for ecological options, please refer to the shower components section (see p. 347-382).

TET-1010-47-xx 10" Flora round shower head  <table border="1"> <thead> <tr> <th>Cx</th> <th>Kx</th> <th>Lx</th> <th>Bx</th> </tr> </thead> <tbody> <tr> <td>999</td> <td>1299</td> <td>1499</td> <td>1499</td> </tr> </tbody> </table>	Cx	Kx	Lx	Bx	999	1299	1499	1499	TET-1010-01-xx 10" round shower head  <table border="1"> <thead> <tr> <th>CC</th> <th>KK</th> <th>LL</th> <th>BB</th> </tr> </thead> <tbody> <tr> <td>575</td> <td>748</td> <td>863</td> <td>863</td> </tr> </tbody> </table>	CC	KK	LL	BB	575	748	863	863	TET-1213-01-xx 12" round shower head  <table border="1"> <thead> <tr> <th>CC</th> </tr> </thead> <tbody> <tr> <td>572</td> </tr> </tbody> </table>	CC	572	TET-1208-01-xx 12" x 8" rectangular shower head  <table border="1"> <thead> <tr> <th>CC</th> <th>KK</th> </tr> </thead> <tbody> <tr> <td>462</td> <td>601</td> </tr> </tbody> </table>	CC	KK	462	601	BRA-1608-00-xx 17" L-shaped shower arm  <table border="1"> <thead> <tr> <th>CC</th> <th>KK</th> <th>LL</th> <th>BB</th> </tr> </thead> <tbody> <tr> <td>368</td> <td>478</td> <td>552</td> <td>552</td> </tr> </tbody> </table>	CC	KK	LL	BB	368	478	552	552										
Cx	Kx	Lx	Bx																																									
999	1299	1499	1499																																									
CC	KK	LL	BB																																									
575	748	863	863																																									
CC																																												
572																																												
CC	KK																																											
462	601																																											
CC	KK	LL	BB																																									
368	478	552	552																																									
TET-0813-01-xx 8" round shower head  <table border="1"> <thead> <tr> <th>CC</th> </tr> </thead> <tbody> <tr> <td>310</td> </tr> </tbody> </table>	CC	310	TET-1013-01-xx 10" round shower head  <table border="1"> <thead> <tr> <th>CC</th> <th>KK</th> </tr> </thead> <tbody> <tr> <td>416</td> <td>541</td> </tr> </tbody> </table>	CC	KK	416	541	TET-1613-01-xx 16" round shower head  <table border="1"> <thead> <tr> <th>CC</th> </tr> </thead> <tbody> <tr> <td>809</td> </tr> </tbody> </table>	CC	809	TET-2012-01-xx 20" x 12" rectangular shower head  <table border="1"> <thead> <tr> <th>CC</th> </tr> </thead> <tbody> <tr> <td>965</td> </tr> </tbody> </table>	CC	965	BRA-1812-02-xx 18" shower arm  <table border="1"> <thead> <tr> <th>CC</th> <th>KK</th> <th>LL</th> <th>BB</th> </tr> </thead> <tbody> <tr> <td>168</td> <td>218</td> <td>252</td> <td>252</td> </tr> </tbody> </table>	CC	KK	LL	BB	168	218	252	252																						
CC																																												
310																																												
CC	KK																																											
416	541																																											
CC																																												
809																																												
CC																																												
965																																												
CC	KK	LL	BB																																									
168	218	252	252																																									
				BRA-1815-02-xx 18" shower arm  <table border="1"> <thead> <tr> <th>CC</th> <th>KK</th> <th>LL</th> <th>BB</th> </tr> </thead> <tbody> <tr> <td>325</td> <td>423</td> <td>488</td> <td>488</td> </tr> </tbody> </table>	CC	KK	LL	BB	325	423	488	488																																
CC	KK	LL	BB																																									
325	423	488	488																																									
DGL-2070-53-xx 3-spray sliding shower bar  <table border="1"> <thead> <tr> <th>CC</th> <th>KK</th> <th>LL</th> <th>BB</th> </tr> </thead> <tbody> <tr> <td>548</td> <td>712</td> <td>822</td> <td>822</td> </tr> </tbody> </table>	CC	KK	LL	BB	548	712	822	822	DGL-2580-53-xx 3-spray sliding shower bar  <table border="1"> <thead> <tr> <th>CC</th> <th>KK</th> <th>LL</th> <th>BB</th> </tr> </thead> <tbody> <tr> <td>594</td> <td>772</td> <td>891</td> <td>891</td> </tr> </tbody> </table>	CC	KK	LL	BB	594	772	891	891	DGL-3080-73-xx 3-spray sliding shower bar  <table border="1"> <thead> <tr> <th>CC</th> <th>KK</th> <th>LL</th> <th>BB</th> </tr> </thead> <tbody> <tr> <td>749</td> <td>974</td> <td>1124</td> <td>1124</td> </tr> </tbody> </table>	CC	KK	LL	BB	749	974	1124	1124	DGL-3097-73-xx Shower column with hand shower, head not included  <table border="1"> <thead> <tr> <th>CC</th> <th>KK</th> <th>LL</th> <th>BB</th> </tr> </thead> <tbody> <tr> <td>999</td> <td>1299</td> <td>1499</td> <td>1499</td> </tr> </tbody> </table>	CC	KK	LL	BB	999	1299	1499	1499	RAC-9001-16-xx 1/2" F wall-mount supply elbow  <table border="1"> <thead> <tr> <th>CC</th> <th>KK</th> <th>LL</th> <th>BB</th> </tr> </thead> <tbody> <tr> <td>124</td> <td>161</td> <td>186</td> <td>186</td> </tr> </tbody> </table>	CC	KK	LL	BB	124	161	186	186
CC	KK	LL	BB																																									
548	712	822	822																																									
CC	KK	LL	BB																																									
594	772	891	891																																									
CC	KK	LL	BB																																									
749	974	1124	1124																																									
CC	KK	LL	BB																																									
999	1299	1499	1499																																									
CC	KK	LL	BB																																									
124	161	186	186																																									
				RAC-9201-02-xx 1/2" F wall-mount supply elbow with integrated volume control  <table border="1"> <thead> <tr> <th>CC</th> <th>KK</th> <th>LL</th> <th>BB</th> </tr> </thead> <tbody> <tr> <td>199</td> <td>259</td> <td>299</td> <td>299</td> </tr> </tbody> </table>	CC	KK	LL	BB	199	259	299	299																																
CC	KK	LL	BB																																									
199	259	299	299																																									
BEC-0520-37-xx Round modern tub spout without diverter  <table border="1"> <thead> <tr> <th>CC</th> <th>KK</th> <th>LL</th> <th>BB</th> </tr> </thead> <tbody> <tr> <td>219</td> <td>285</td> <td>329</td> <td>329</td> </tr> </tbody> </table>	CC	KK	LL	BB	219	285	329	329	BEC-0520-51-xx MA tub spout without diverter  <table border="1"> <thead> <tr> <th>CC</th> <th>KK</th> <th>LL</th> <th>BB</th> </tr> </thead> <tbody> <tr> <td>319</td> <td>415</td> <td>479</td> <td>479</td> </tr> </tbody> </table>	CC	KK	LL	BB	319	415	479	479	BEC-0520-73-xx 7" round tub spout without diverter  <table border="1"> <thead> <tr> <th>CC</th> <th>KK</th> <th>LL</th> <th>BB</th> </tr> </thead> <tbody> <tr> <td>168</td> <td>218</td> <td>252</td> <td>252</td> </tr> </tbody> </table>	CC	KK	LL	BB	168	218	252	252	BOD-5007-01-xx Round built-in lateral body jet  <table border="1"> <thead> <tr> <th>CC</th> <th>KK</th> <th>LL</th> <th>BB</th> </tr> </thead> <tbody> <tr> <td>325</td> <td>423</td> <td>488</td> <td>488</td> </tr> </tbody> </table>	CC	KK	LL	BB	325	423	488	488	RAC-9001-21-xx Wall-mount handshower holder and supply elbow  <table border="1"> <thead> <tr> <th>Cx</th> <th>Kx</th> <th>Lx</th> <th>Bx</th> </tr> </thead> <tbody> <tr> <td>323</td> <td>420</td> <td>517</td> <td>517</td> </tr> </tbody> </table>	Cx	Kx	Lx	Bx	323	420	517	517
CC	KK	LL	BB																																									
219	285	329	329																																									
CC	KK	LL	BB																																									
319	415	479	479																																									
CC	KK	LL	BB																																									
168	218	252	252																																									
CC	KK	LL	BB																																									
325	423	488	488																																									
Cx	Kx	Lx	Bx																																									
323	420	517	517																																									

Actual products may differ from pictures. Actual products measures may differ from the measures shown. All USD prices are subject to change without notice. Effective as of August 2023.

COMPLETE SHOWER KITS

PRO-3302-47-xx PRR-3302-47-xx*

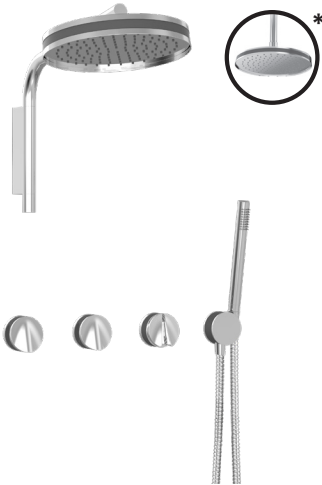

Complete thermostatic shower kit

Cx	Kx	Lx	Bx	Nx/Yx	Vx/Tx	Gx
3195	4154	4793	4793	4154	5112	7029

Features

- A- 2 accessories kit
- B- Max: 2 gpm - 80 psi (per accessory)
- C- 1-spray hand shower
- D- 2 accessories can work together
- E- Double hook as part of the thermostatic valve trim

Includes

- B47-9453-00-xx** Complete 3/4" thermostatic valve
- B47-9560-02-xx** Complete 2-port diverter with off
- TET-1010-47-xx** 10" Flora round shower head
- BRA-1608-00-xx** 17" L-shaped shower arm
- DSP-2604-21-xx** Hand shower on wall-mounted supply elbow

Ecological options CEC

Codes	Features are the same, except:
PRO-3302-47-xx-NS	B- Max: 1.75 gpm - 80 psi (per accessory) D- 1 accessory works at a time
TRO-3302-47-xx-NS + RVA-3453-00-B + RVA-9562-00-NS-B	

TRIM ONLY

TRO-3302-47-xx TRR-3302-47-xx*	Cx	Kx	Lx	Bx	Nx/Yx	Vx/Tx	Gx
	2247	3206	3845	3845	3206	4164	6081

ROUGH VALVES Please order **all** of the following rough valves to complete the trim:

RVA-3453-00-B	Type T rough - 3/4" female NPT connections	649
RVA-9562-00-B	2-port diverter rough - 1/2" male NPT or welded copper connections	299

PRO-3303-47-xx PRR-3303-47-xx*

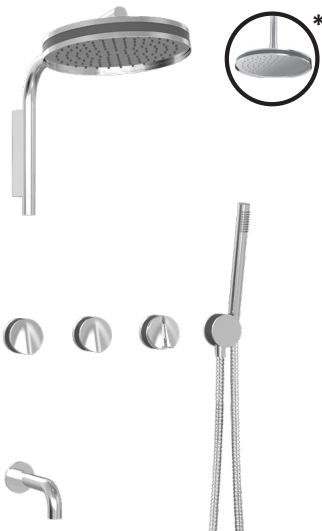

Complete thermostatic shower kit

Cx	Kx	Lx	Bx	Nx/Yx	Vx/Tx	Gx
3450	4485	5175	5175	4485	5520	7590

Features

- A- 3 accessories kit
- B- 9.7 gpm - 60 psi (bath spout)
- C- Max: 2 gpm - 80 psi (shower accessories)
- D- 1-spray hand shower
- E- 2 accessories can work together
- F- Double hook as part of the thermostatic valve trim

Includes

- B47-9453-00-xx** Complete 3/4" thermostatic valve
- B47-9560-03-xx** Complete 3-port diverter with off
- BEC-0520-37-xx** Modern round tub spout without diverter
- TET-1010-47-xx** 10" Flora round shower head
- BRA-1608-00-xx** 17" L-shaped shower arm
- DSP-2604-21-xx** Hand shower on wall-mounted supply elbow

Ecological options CEC

Codes	Features are the same, except:
PRO-3303-47-xx-NS	C- Max: 1.75 gpm - 80 psi (shower accessories) E- 1 accessory works at a time
TRO-3303-47-xx-NS + RVA-3453-00-B + RVA-9563-00-NS-B	

TRIM ONLY

TRO-3303-47-xx TRR-3303-47-xx*	Cx	Kx	Lx	Bx	Nx/Yx	Vx/Tx	Gx
	2420	3455	4145	4145	3455	4490	6560

ROUGH VALVES Please order **all** of the following rough valves to complete the trim:

RVA-3453-00-B	Type T rough - 3/4" female NPT connections	649
RVA-9563-00-B	3-port diverter rough - inlet: 3/4" F NPT - outlets: 1/2" F NPT	381

MAIN FINISHES (faucet body, flanges and handle covers):

C= chrome, N= brushed nickel, K= matte black, L= satin brass, B = white, Y= polished nickel T= venetian bronze, V= satin copper, G= gold

SECONDARY FINISHES (color accent):

A= matte silver, B= white, C= chrome, F= smokey, G= gold, N= brushed nickel, K= matte black, Q= marble, W= wood, L= satin brass, T= venetian bronze, V= satin copper, Y= polished nickel

The products in this section are shown in smokey chrome (CF).

* With 6" ceiling mount shower arm

FLORA B47

PRO-3304-47-xx

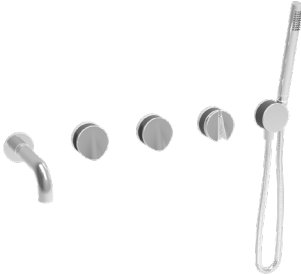

Complete thermostatic shower kit

Cx	Kx	Lx	Bx	Nx/Yx	Vx/Tx	Gx
2295	2984	3443	3443	2984	3672	5049

Features

- A- 2 accessories kit
- B- 9.7 gpm - 60 psi (bath spout)
- C- Max: 2 gpm - 80 psi (shower accessories)
- D- 1-spray hand shower
- E- 2 accessories can work together
- F- Double hook as part of the thermostatic valve trim

Includes

- B47-9453-00-xx** Complete 3/4" thermostatic valve
- B47-9560-02-xx** Complete 2-port diverter with off
- BEC-0520-37-xx** Modern round tub spout without diverter
- DSP-2604-21-xx** Hand shower on wall-mounted supply elbow

Ecological options **CEC**

Codes

PRO-3304-47-xx-NS
 TRO-3304-47-xx-NS + RVA-3453-00-B +
 RVA-9562-00-NS-B

Features are the same, **except:**

C- Max: 1.75 gpm - 80 psi (shower accessories)
 E- 1 accessory works at a time

TRIM ONLY

TRO-3304-47-xx

Cx	Kx	Lx	Bx	Nx/Yx	Vx/Tx	Gx
1347	2036	2495	2495	2036	2724	4101

ROUGH VALVES Please order **all** of the following rough valves to complete the trim:

RVA-3453-00-B

Type T rough - 3/4" female NPT connections

649

RVA-9562-00-B

2-port diverter rough - 1/2" male NPT or welded copper connections

299

PRO-3352-47-xx

PRR-3352-47-xx*

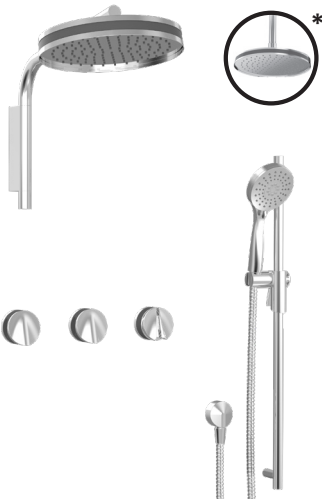

Complete thermostatic shower kit

Cx	Kx	Lx	Bx	Nx/Yx	Vx/Tx	Gx
3185	4141	4778	4778	4141	5096	7007

Features

- A- 2 accessories kit
- B- Max: 2 gpm - 80 psi (per accessory)
- C- 3-spray hand shower
- D- 2 accessories can work together
- E- Double hook as part of the thermostatic valve trim

Includes

- B47-9453-00-xx** Complete 3/4" thermostatic valve
- B47-9560-02-xx** Complete 2-port diverter with off
- TET-1010-47-xx** 10" Flora round shower head
- BRA-1608-00-xx** 17" L-shaped shower arm
- DGL-2070-53-xx** 3-spray sliding shower bar
- RAC-9001-13-xx** Wall-mount supply elbow

Ecological options **CEC**

Codes

PRO-3352-47-xx-NS
 TRO-3352-47-xx-NS + RVA-3453-00-B +
 RVA-9562-00-NS-B

Features are the same, **except:**

B- Max: 1.75 gpm - 80 psi (per accessory)
 D- 1 accessory works at a time

TRIM ONLY

TRO-3352-47-xx

TRR-3352-47-xx*

Cx	Kx	Lx	Bx	Nx/Yx	Vx/Tx	Gx
2237	3193	3830	3830	3193	4148	6059

ROUGH VALVES Please order **all** of the following rough valves to complete the trim:

RVA-3453-00-B

Type T rough - 3/4" female NPT connections

649

RVA-9562-00-B

2-port diverter rough - 1/2" male NPT or welded copper connections

299

SELECTION OF BATHROOM ACCESSORIES

For more bathroom accessories, please refer to the bathroom accessories section (see p. 293-306).

A46-1029-00-xx

PROFILE
Wall-mounted toilet paper holder



CC	KK	LL	BB	NN/YY	VV/TT	CF
226	294	339	339	294	361	226

A47-1069-00-xx

FLORA
Bathrobe holder



Cx	Kx	Lx	Bx	Nx/Yx	Vx/Tx	Gx
219	285	329	329	285	350	482

A46-6012-00-xx

PROFILE
12" single towel bar

Available Q3 2023



CC	KK	LL	BB	NN/YY	VV/TT	CF
292	380	438	438	380	467	292

A46-6018-00-xx

PROFILE
18" single towel bar



CC	KK	LL	BB	NN/YY	VV/TT	CF
322	419	483	483	419	515	322

A46-6024-00-xx

PROFILE
24" single towel bar



CC	KK	LL	BB	NN/YY	VV/TT	CF
364	473	546	546	473	582	364

A46-6030-00-xx

PROFILE
30" single towel bar



CC	KK	LL	BB	NN/YY	VV/TT	CF
439	570	658	658	570	702	439

MAIN FINISHES (faucet body, flanges and handle covers):

C= chrome, N= brushed nickel, K= matte black, L= satin brass, B = white, Y= polished nickel T= venetian bronze, V= satin copper, , G= gold

SECONDARY FINISHES (color accent):

A= matte silver, B= white, C= chrome, F= smokey, G= gold, N= brushed nickel, K= matte black, Q= marble, W= wood,

L= satin brass, T= venetian bronze, V= satin copper, Y= polished nickel

The products in this section are shown in smokey chrome (CF).

MA B51

Compatible with the Touchless Sensor
Order ELE-2001-01-xx (p. 43)



BARIL

MA B51

B51-1010-1PL-xx

DRAIN INCLUDED  

CC	CF	KK	BB
894	894	1149	1326



GRANDS PRIX DU DESIGN

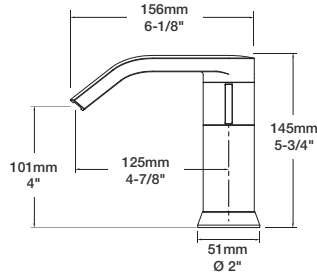

Single-hole lavatory faucet, drain included

- A- 1.5 gpm - 60 psi
- B- CAR-1400-28
- C- Progressive cartridge
- D- Push-button drain with overflow included

Ecological options

Codes	Reduced flow rates
B51-1010-XXL-xx-120	1.2 gpm (4.5 l/min) - 60 psi 

DRAIN NOT INCLUDED

B51-1010-00L-xx

D- Order your lavatory drain (pages 309-310)

CC	CF	KK	BB
846	846	1086	1254

B51-8009-00L-xx

 **CEC** 

CC	CF	KK	BB
1138	1138	1480	1708

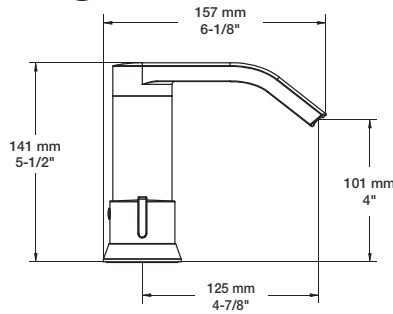

8" c/c lavatory faucet, drain included

- A- 1.2 gpm - 60 psi
- B- Push-button drain with overflow included
- C- CAR-3820-01 (Cold), CAR-3820-02 (Hot)

B51-8100-00L-xx



CC	CF	KK	BB
734	734	954	1101



GRANDS PRIX DU DESIGN

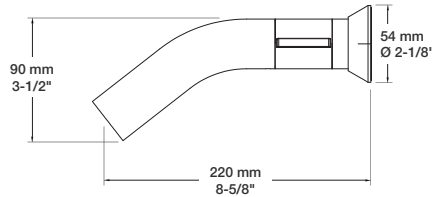

Single lever wall-mounted lavatory faucet, drain not included

- A- 1.5 gpm - 60 psi
- B- Order your lavatory drain (pages 309-310)
- C- Adjustable aerator
- D- CAR-1400-28
- E- Progressive cartridge

Ecological options

Codes	Reduced flow rates
B51-8100-00L-xx-120	1.2 gpm (4.5 l/min) - 60 psi 
B51-8100-00L-xx-100	1.0 gpm (3.7 l/min) - 60 psi
B51-8100-00L-xx-050	0.5 gpm (1.9 l/min) - 60 psi

B51-1469-00-xx

CC	CF	KK	BB
1589	1589	2066	2383



GRANDS PRIX DU DESIGN

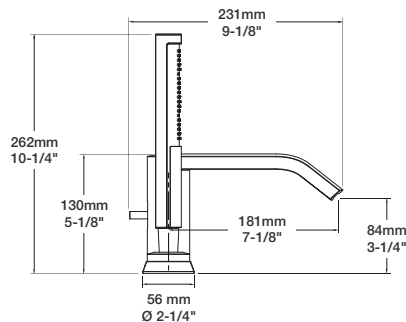

4-piece tub filler with hand shower

Bath spout:

- A- 8.2 gpm - 60 psi

Hand shower:

- B- Max: 2 gpm - 80 psi
- C- Hand shower - 2 choices of installation
- D- DOU-2652-01-CF
- E- CAR-1020-01 (Cold), CAR-1020-02 (Hot)

Ecological options

Codes	Reduced flow rates
B51-1469-00-xx-150	1.5 gpm (5.7 l/min) - 80 psi 
B51-1469-00-xx-175	1.75 gpm (6.6 l/min) - 80 psi

Actual products may differ from pictures. Actual products measures may differ from the measures shown. All USD prices are subject to change without notice. Effective as of August 2023.

B51-9521-00-xx

ROUGH & TRIM PACKAGE

CC	CF	KK	BB
1303	1303	1489	1613

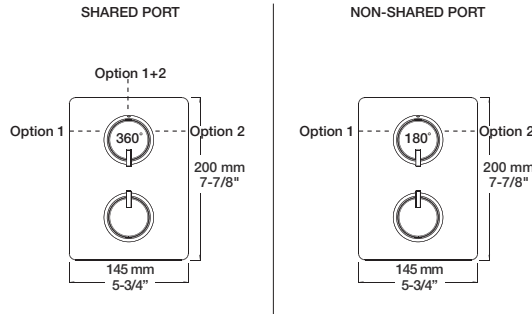

Complete thermostatic pressure balanced shower control valve with 2-way diverter (shared port)

- A- 1 outlet: 7.9 gpm - 60 psi, 2 outlets: 3.7 gpm - 60 psi
- B- Up to 2 accessories can be used at the same time
- C- Thin brass plate
- D- Reversible check / non-return valves in case of water supply inversion
- E- CAR-2661-00 (temperature), CAR-3003-36 (diverter)
- F- Rough valve RVA-9521-00-B included
- G- Large depth adjustment range

Ecological options CEC

Codes	Features
B51-9521-00-xx-NS	Non-shared port
T51-9521-00-xx + RVA-9521-00-NS-B	1 accessory works at a time
T51-9521-00-xx + RVA-9521-PO-NS-B	CAR-3003-36-NS (diverter)

TRIM ONLY

T51-9521-00-xx

CC	CF	KK	BB
618	618	804	928

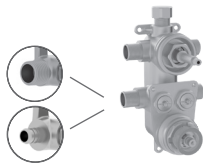

ROUGH VALVES Please order **one** of the following rough valves to complete the trim:

RVA-9521-00-B 2-way TP rough - 1/2" male NPT or welded copper connections **685**

RVA-9521-PO-B 2-way TP rough - PEX connections **685**

B51-9531-00-xx

ROUGH & TRIM PACKAGE

CC	CF	KK	BB
1413	1413	1599	1723

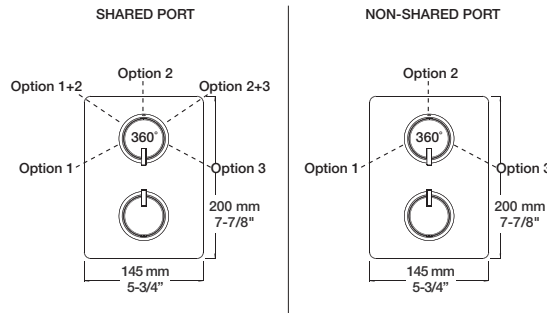

Complete thermostatic pressure balanced shower control valve with 3-way diverter (shared port)

- A- 1 outlet: 7.9 gpm - 60 psi, 2 outlets: 3.7 gpm - 60 psi
- B- Up to 2 accessories can be used at the same time
- C- Thin brass plate
- D- Reversible check / non-return valves in case of water supply inversion
- E- CAR-2661-00 (temperature), CAR-9531-03 (diverter)
- F- Rough valve RVA-9531-00-B included
- G- Large depth adjustment range

Ecological options CEC

Codes	Features
B51-9531-00-xx-NS	Non-shared port
T51-9531-00-xx + RVA-9531-00-NS-B	1 accessory works at a time
T51-9531-00-xx + RVA-9531-PO-NS-B	CAR-9531-03-NS (diverter)

TRIM ONLY

T51-9531-00-xx

CC	CF	KK	BB
618	618	804	928

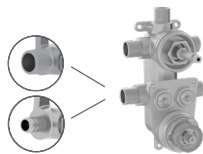

ROUGH VALVES Please order **one** of the following rough valves to complete the trim:

RVA-9531-00-B 3-way TP rough - 1/2" male NPT or welded copper connections **795**

RVA-9531-PO-B 3-way TP rough - PEX connections **795**









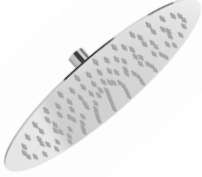
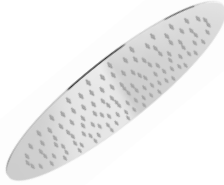
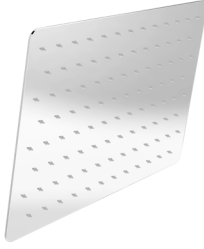

Finishes:

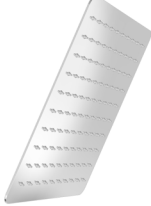
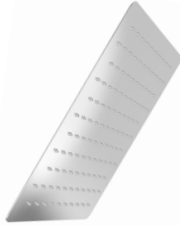
CC = chrome, CF = smokey chrome, KK = matte black, BB = white
The products in this section are shown in smokey chrome.

MA B51

SELECTION OF SHOWER COMPONENTS

For more shower components and for ecological options, please refer to the shower components section (see p. 347-382).

TET-0810-01-xx 8" round shower head  <table border="1"> <thead> <tr> <th>CC</th> <th>KK</th> <th>LL</th> <th>BB</th> </tr> </thead> <tbody> <tr> <td>445</td> <td>579</td> <td>668</td> <td>668</td> </tr> </tbody> </table>	CC	KK	LL	BB	445	579	668	668	TET-1213-01-xx 12" round shower head  <table border="1"> <thead> <tr> <th>CC</th> </tr> </thead> <tbody> <tr> <td>572</td> </tr> </tbody> </table>	CC	572	TET-1613-01-xx 16" round shower head  <table border="1"> <thead> <tr> <th>CC</th> </tr> </thead> <tbody> <tr> <td>809</td> </tr> </tbody> </table>	CC	809	TET-2012-01-xx 20" x 12" rectangular shower head  <table border="1"> <thead> <tr> <th>CC</th> </tr> </thead> <tbody> <tr> <td>965</td> </tr> </tbody> </table>	CC	965	BRA-1612-44-xx 16" shower arm  <table border="1"> <thead> <tr> <th>CC</th> <th>KK</th> <th>LL</th> <th>BB</th> </tr> </thead> <tbody> <tr> <td>199</td> <td>259</td> <td>299</td> <td>299</td> </tr> </tbody> </table>	CC	KK	LL	BB	199	259	299	299																		
CC	KK	LL	BB																																									
445	579	668	668																																									
CC																																												
572																																												
CC																																												
809																																												
CC																																												
965																																												
CC	KK	LL	BB																																									
199	259	299	299																																									
TET-0811-02-xx 8" square shower head  <table border="1"> <thead> <tr> <th>CC</th> <th>KK</th> <th>LL</th> <th>BB</th> </tr> </thead> <tbody> <tr> <td>460</td> <td>598</td> <td>690</td> <td>690</td> </tr> </tbody> </table>	CC	KK	LL	BB	460	598	690	690	TET-1214-01-xx 12" square shower head  <table border="1"> <thead> <tr> <th>CC</th> </tr> </thead> <tbody> <tr> <td>595</td> </tr> </tbody> </table>	CC	595	TET-1614-01-xx 16" square shower head  <table border="1"> <thead> <tr> <th>CC</th> </tr> </thead> <tbody> <tr> <td>832</td> </tr> </tbody> </table>	CC	832	TET-3018-01-xx Adjustable 3-stem shower head  <table border="1"> <thead> <tr> <th>CC/CF</th> <th>KK</th> <th>LL</th> <th>BB</th> </tr> </thead> <tbody> <tr> <td>1395</td> <td>1814</td> <td>2093</td> <td>2093</td> </tr> </tbody> </table>	CC/CF	KK	LL	BB	1395	1814	2093	2093	BRA-1812-02-xx 18" shower arm  <table border="1"> <thead> <tr> <th>CC</th> <th>KK</th> <th>LL</th> <th>BB</th> </tr> </thead> <tbody> <tr> <td>168</td> <td>218</td> <td>252</td> <td>252</td> </tr> </tbody> </table>	CC	KK	LL	BB	168	218	252	252												
CC	KK	LL	BB																																									
460	598	690	690																																									
CC																																												
595																																												
CC																																												
832																																												
CC/CF	KK	LL	BB																																									
1395	1814	2093	2093																																									
CC	KK	LL	BB																																									
168	218	252	252																																									
DGL-2070-51-xx 1-spray sliding shower bar  <table border="1"> <thead> <tr> <th>CC</th> <th>KK</th> <th>LL</th> <th>BB</th> </tr> </thead> <tbody> <tr> <td>679</td> <td>883</td> <td>1019</td> <td>1019</td> </tr> </tbody> </table>	CC	KK	LL	BB	679	883	1019	1019	DGL-2070-57-xx 3-spray sliding shower bar  <table border="1"> <thead> <tr> <th>CC</th> <th>KK</th> <th>LL</th> <th>BB</th> </tr> </thead> <tbody> <tr> <td>594</td> <td>772</td> <td>891</td> <td>891</td> </tr> </tbody> </table>	CC	KK	LL	BB	594	772	891	891	DSP-2604-19-xx Hand shower on wall-mounted supply elbow  <table border="1"> <thead> <tr> <th>CC</th> <th>KK</th> <th>LL</th> <th>BB</th> </tr> </thead> <tbody> <tr> <td>492</td> <td>639</td> <td>738</td> <td>738</td> </tr> </tbody> </table>	CC	KK	LL	BB	492	639	738	738	DSP-2604-21-xx Hand shower on wall-mounted supply elbow  <table border="1"> <thead> <tr> <th>CC</th> <th>KK</th> <th>LL</th> <th>BB</th> </tr> </thead> <tbody> <tr> <td>641</td> <td>833</td> <td>994</td> <td>994</td> </tr> </tbody> </table>	CC	KK	LL	BB	641	833	994	994	RAC-0618-02-xx 6" ceiling mount shower arm  <table border="1"> <thead> <tr> <th>CC</th> <th>KK</th> <th>LL</th> <th>BB</th> </tr> </thead> <tbody> <tr> <td>68</td> <td>88</td> <td>102</td> <td>102</td> </tr> </tbody> </table>	CC	KK	LL	BB	68	88	102	102
CC	KK	LL	BB																																									
679	883	1019	1019																																									
CC	KK	LL	BB																																									
594	772	891	891																																									
CC	KK	LL	BB																																									
492	639	738	738																																									
CC	KK	LL	BB																																									
641	833	994	994																																									
CC	KK	LL	BB																																									
68	88	102	102																																									
BEC-0520-51-xx MA tub spout without diverter  <table border="1"> <thead> <tr> <th>CC/CF</th> <th>KK</th> <th>LL</th> <th>BB</th> </tr> </thead> <tbody> <tr> <td>319</td> <td>415</td> <td>479</td> <td>479</td> </tr> </tbody> </table>	CC/CF	KK	LL	BB	319	415	479	479																																				
CC/CF	KK	LL	BB																																									
319	415	479	479																																									

Actual products may differ from pictures. Actual products measures may differ from the measures shown. All USD prices are subject to change without notice. Effective as of August 2023.

COMPLETE SHOWER KITS

PRO-4216-51-xx PRR-4216-51-xx*

Complete thermostatic pressure balanced shower kit

CC	CF	KK	BB
2445	2445	3179	3668



Features

- A- 2 accessories kit
- B- Max: 2 gpm - 80 psi (per accessory)
- C- 3-spray hand shower
- D- 2 accessories can work together

Includes

- B51-9521-00-xx** Complete TP shower control valve with 2-way diverter
- TET-1011-01-xx** 10" square shower head
- BRA-1612-66-xx** 16" shower arm
- DGL-2070-57-xx** 3-spray sliding shower bar
- RAC-9001-16-xx** Wall-mount supply elbow

Ecological options CEC

Codes

PRO-4216-51-xx-NS
TRO-4216-51-xx-NS + RVA-9521-00-NS-B

Features are the same, except:

B- Max: 1.75 gpm - 80 psi (per accessory)
D- 1 accessory works at a time

TRIM ONLY

TRO-4216-51-xx TRR-4216-51-xx*

CC	CF	KK	BB
1760	1760	2494	2983

ROUGH VALVES Please order **one** of the following rough valves to complete the trim:

RVA-9521-00-B	2-way TP rough - 1/2" male NPT or welded copper connections	685
RVA-9521-PO-B	2-way TP rough - PEX connections	685

PRO-4291-51-xx PRR-4291-51-xx*

Complete thermostatic pressure balanced shower kit

CC	CF	KK	BB
2375	2375	3088	3563

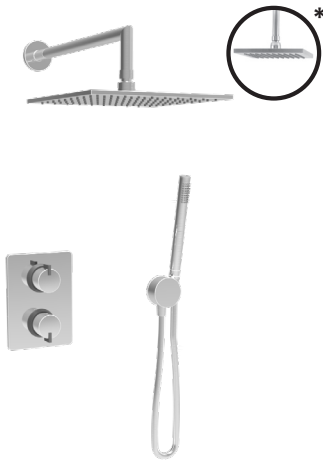

Features

- A- 2 accessories kit
- B- Max: 2 gpm - 80 psi (per accessory)
- C- 1-spray hand shower
- D- 2 accessories can work together

Includes

- B51-9521-00-xx** Complete TP shower control valve with 2-way diverter
- TET-1011-01-xx** 10" square shower head
- BRA-1612-66-xx** 16" shower arm
- DSP-2604-21-xx** Hand shower on wall-mounted supply elbow

Ecological options CEC

Codes

PRO-4291-51-xx-NS
TRO-4291-51-xx-NS + RVA-9521-00-NS-B

Features are the same, except:

B- Max: 1.75 gpm - 80 psi (per accessory)
D- 1 accessory works at a time

TRIM ONLY

TRO-4291-51-xx TRR-4291-51-xx*

CC	CF	KK	BB
1690	1690	2403	2878

ROUGH VALVES Please order **one** of the following rough valves to complete the trim:

RVA-9521-00-B	2-way TP rough - 1/2" male NPT or welded copper connections	685
RVA-9521-PO-B	2-way TP rough - PEX connections	685

Finishes:

CC = chrome, CF = smokey chrome, KK = matte black, BB = white
The products in this section are shown in smokey chrome.

* With 6" ceiling mount shower arm

MA B51

SELECTION OF BATHROOM ACCESSORIES

For more bathroom accessories, please refer to the bathroom accessories section (see p. 293-306).

A46-1029-00-xx

PROFILE
Wall-mounted toilet paper holder



CC	CF	KK	BB
226	226	294	339

A46-1069-00-xx

PROFILE
Bathrobe holder



CC	CF	KK	BB
126	126	164	189

A46-6012-00-xx

PROFILE
12" single towel bar

Available Q3 2023



CC	CF	KK	BB
292	292	380	438

A46-6018-00-xx

PROFILE
18" single towel bar



CC	CF	KK	BB
322	322	419	483

A46-6024-00-xx

PROFILE
24" single towel bar



CC	CF	KK	BB
364	364	473	546

A46-6030-00-xx

PROFILE
30" single towel bar



CC	CF	KK	BB
439	439	570	658

Actual products may differ from pictures. Actual products measures may differ from the measures shown. All USD prices are subject to change without notice. Effective as of August 2023.

ACCENT B56

Compatible with the Touchless Sensor
Order ELE-2001-01-xx (p. 43)



BARIL

ACCENT B56

B56-1010-1PL-xx

DRAIN INCLUDED



ADA



CC	CB	CF
839	839	839

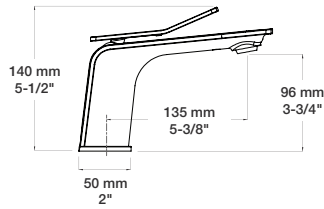

Single-hole lavatory faucet, drain included

- A- Max: 1.5 gpm - 60 psi
- B- Easy-to-clean adjustable silicone aerator
- C- CAR-1025-05
- D- Push-button drain with overflow included

Ecological options

Codes	Reduced flow rates	
B56-1010-XXL-xx-120	1.2 gpm (4.5 l/min) - 60 psi	CEC
B56-1010-XXL-xx-100	1.0 gpm (3.7 l/min) - 60 psi	
B56-1010-XXL-xx-050	0.5 gpm (1.9 l/min) - 60 psi	

DRAIN NOT INCLUDED

B56-1010-00L-xx

D- Order your lavatory drain (pages 309-310)

CC	CB	CF
791	791	791

B56-8009-00L-xx

CC	CB	CF
1218	1218	1218

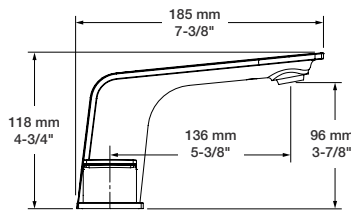

8" c/c lavatory faucet, drain included

- A- Max: 1.5 gpm - 60 psi
- B- Push-button drain with overflow included
- C- Easy-to-clean adjustable silicone aerator
- D- CAR-3820-01 (Cold), CAR-3820-02 (Hot)

Ecological options

Codes	Reduced flow rates	
B56-8009-00L-xx-120	1.2 gpm (4.5 l/min) - 60 psi	CEC
B56-8009-00L-xx-100	1.0 gpm (3.7 l/min) - 60 psi	
B56-8009-00L-xx-050	0.5 gpm (1.9 l/min) - 60 psi	

B56-1100-00-xx

COMPLETE FAUCET

ADA

CC	CB	CF
3496	3496	3496

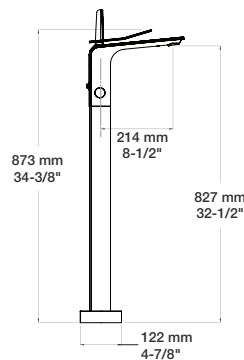

Floor-mounted tub filler with hand shower

Bath spout:

- A- 7.9 gpm - 60 psi
- B- Tub spout with integrated push-button diverter

Hand shower:

- C- Max: 2 gpm - 80 psi
- D- Reclining hand shower holder
- E- Built-in hook on the hand shower holder
- F- Hand shower DOU-2653-01-xx with 59" PVC hose
- G- CAR-1060-01

Ecological options

Codes	Reduced flow rates	
B56-1100-00-xx-150	1.5 gpm (5.7 l/min) - 80 psi	
B56-1100-00-xx-175	1.75 gpm (6.6 l/min) - 80 psi	CEC

TRIM ONLY

T56-1100-00-xx

CC	CB	CF
3361	3361	3361

MOUNTING KIT Please order the following kit to complete the trim:

FIX-1100-00-B

Floor mounting kit for floor-mounted tub filler with hand shower

135



Actual products may differ from pictures. Actual products measures may differ from the measures shown. All USD prices are subject to change without notice. Effective as of August 2023.

ACCENT B56

B56-1249-00-xx

CC	CB	CF
1497	1497	1497

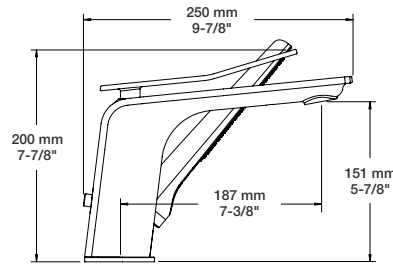

2-piece tub filler with hand shower

Bath spout:

- A- 7.1 gpm - 60 psi
- B- Tub spout with integrated push-button diverter

Hand shower:

- C- Max: 2 gpm - 80 psi
- D- DOU-2653-01-xx
- E- CAR-1031-49

Ecological options

Codes	Reduced flow rates
B56-1249-00-xx-150	1.5 gpm (5.7 l/min) - 80 psi
B56-1249-00-xx-175	1.75 gpm (6.6 l/min) - 80 psi

B56-9404-00-xx

ROUGH & TRIM PACKAGE

CC	CB	CF
1323	1323	1323

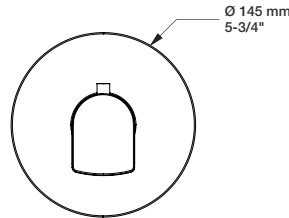

Complete 3/4" thermostatic valve

- A- 16 gpm - 60 psi
- B- Separate volume control or diverter valve required
- C- Can easily supply 3 accessories
- D- Thin brass plate
- E- CAR-3404-00
- F- Rough valve RVA-3404-00-B included
- G- Reversible check / non-return valves in case of water supply inversion

TRIM ONLY

T56-9404-00-xx

CC	CB	CF
641	641	641

ROUGH VALVE Please order the following rough valve to complete the trim:

RVA-3404-00-B

Type T rough - 3/4" female NPT connections

682



B56-9521-00-xx

ROUGH & TRIM PACKAGE

CC	CB	CF
1303	1303	1303

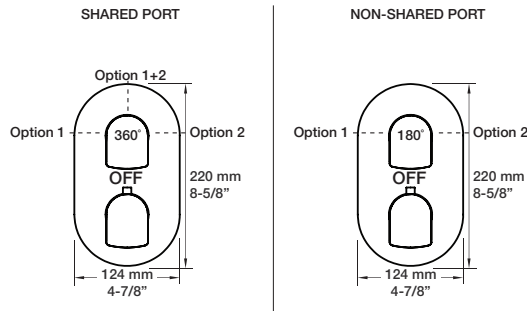
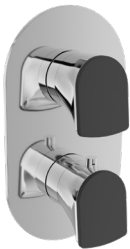

Complete thermostatic pressure balanced shower control valve with 2-way diverter (shared port)

- A- 1 outlet: 7.9 gpm - 60 psi, 2 outlets: 3.7 gpm - 60 psi
- B- Up to 2 accessories can be used at the same time
- C- Thin brass plate
- D- Reversible check / non-return valves in case of water supply inversion
- E- CAR-2661-00 (temperature), CAR-3003-36 (diverter)
- F- Rough valve RVA-9521-00-B included
- G- Large depth adjustment range

Ecological options CEC

Codes	Features
B56-9521-00-xx-NS	Non-shared port
T56-9521-00-xx + RVA-9521-00-NS-B	1 accessory works at a time
T56-9521-00-xx + RVA-9521-PO-NS-B	CAR-3003-36-NS (diverter)

TRIM ONLY

T56-9521-00-xx

CC	CB	CF
618	618	618

ROUGH VALVES Please order **one** of the following rough valves to complete the trim:

RVA-9521-00-B

2-way TP rough - 1/2" male NPT or welded copper connections

685

RVA-9521-PO-B

2-way TP rough - PEX connections

685

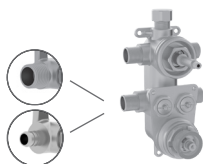

Finishes:

CC = chrome, CB = chrome white, CF = smokey chrome
The products in this section are shown in smokey chrome.

ACCENT B56

B56-9531-00-xx

ROUGH & TRIM PACKAGE

CC	CB	CF
1413	1413	1413

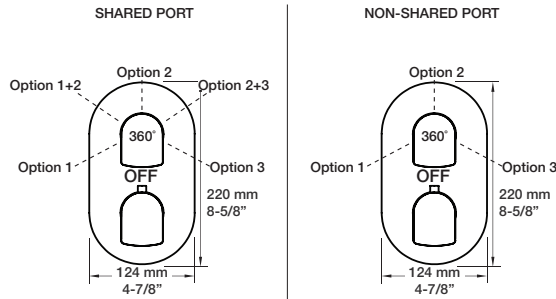
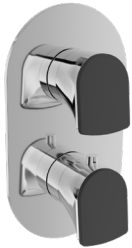

Complete thermostatic pressure balanced shower control valve with 3-way diverter (shared port)

- A- 1 outlet: 7.9 gpm - 60 psi, 2 outlets: 3.7 gpm - 60 psi
- B- Up to 2 accessories can be used at the same time
- C- Thin brass plate
- D- Reversible check / non-return valves in case of water supply inversion
- E- CAR-2661-00 (temperature), CAR-9531-03 (diverter)
- F- Rough valve RVA-9531-00-B included
- G- Large depth adjustment range

Ecological options CEC

Codes	Features
B56-9531-00-xx-NS	Non-shared port
T56-9531-00-xx + RVA-9531-00-NS-B	1 accessory works at a time
T56-9531-00-xx + RVA-9531-P0-NS-B	CAR-9531-03-NS (diverter)

TRIM ONLY

T56-9531-00-xx

CC	CB	CF
618	618	618

ROUGH VALVES Please order **one** of the following rough valves to complete the trim:

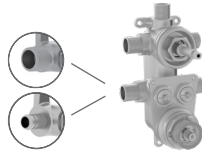

RVA-9531-00-B

3-way TP rough - 1/2" male NPT or welded copper connections

795

RVA-9531-P0-B

3-way TP rough - PEX connections

795

B56-9560-02-xx

ROUGH & TRIM PACKAGE

CC	CB	CF
596	596	596

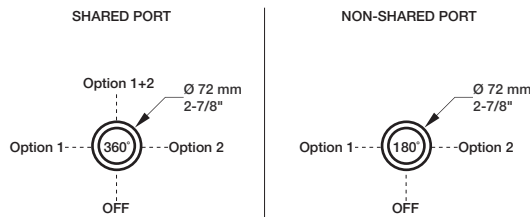

Complete 2-port diverter with stop (shared port)

- A- 1 outlet: 10.5 gpm - 60 psi, 2 outlets: 4 gpm - 60 psi
- B- Can replace 2 volume control valves
- C- Up to 2 accessories can be used at the same time
- D- CAR-9525-02
- E- Rough RVA-9562-00-B included
- F- Extra long cartridge for maximum adjustment

Ecological options CEC

Codes	Features
B56-9560-02-xx-NS	Non-shared port
T56-9560-02-xx + RVA-9562-00-NS-B	1 accessory works at a time
	CAR-9525-02-NS (diverter)

TRIM ONLY

T56-9560-02-xx

CC	CB	CF
297	297	297

ROUGH VALVE Please order the following rough valve to complete the trim:



RVA-9562-00-B

2-port diverter rough - 1/2" male NPT or welded copper connections

299

Actual products may differ from pictures. Actual products measures may differ from the measures shown. All USD prices are subject to change without notice. Effective as of August 2023.

ACCENT B56

B56-9560-03-xx

ROUGH & TRIM PACKAGE

CC	CB	CF
678	678	678

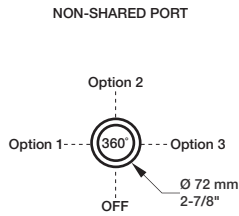
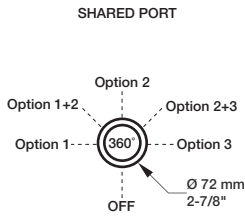

Complete 3-port diverter with stop (shared port)

- A- 1 outlet: 9.7 gpm - 60 psi, 2 outlets: 5.2 gpm - 60 psi
- B- Can replace 2 or 3 volume control valves
- C- Up to 2 accessories can be used at the same time
- D- CAR-9530-03
- E- Rough RVA-9563-00-B included
- F- Extra long cartridge for maximum adjustment

Ecological options CEC

Codes	Features
B56-9560-03-xx-NS	Non-shared port
T56-9560-03-xx + RVA-9563-00-NS-B	1 accessory works at a time CAR-9530-03-NS (diverter)

TRIM ONLY

T56-9560-03-xx

CC	CB	CF
297	297	297



ROUGH VALVE Please order the following rough valve to complete the trim:

RVA-9563-00-B

3-port diverter rough - inlet: 3/4" F NPT - outlets: 1/2" F NPT

381

B56-9649-00-xx

ROUGH & TRIM PACKAGE

CC	CB	CF
532	532	532

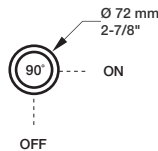

Complete 3/4" volume control valve

- A- 11.1 gpm - 60 psi
- B- Volume control valve
- C- Offers higher flow
- D- CAR-2719-34
- E- Rough valve RVA-2719-34-B included
- F- Extra long cartridge for maximum adjustment

TRIM ONLY

T56-9649-00-xx

CC	CB	CF
297	297	297



ROUGH VALVE Please order the following rough valve to complete the trim:

RVA-2719-34-B

Volume control valve rough - 3/4" female NPT connections

235













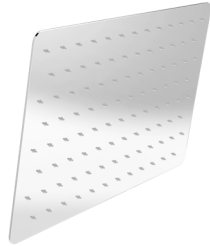

Finishes:

CC = chrome, CB = chrome white, CF = smokey chrome
The products in this section are shown in smokey chrome.

ACCENT B56

SELECTION OF SHOWER COMPONENTS

For more shower components and for ecological options, please refer to the shower components section (see p. 347-382).

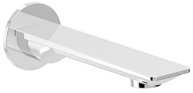
<p>TET-0813-01-xx 8" round shower head</p>  <p>CC 310</p>	<p>TET-1213-01-xx 12" round shower head</p>  <p>CC 572</p>	<p>TET-1208-01-xx 12" x 8" rectangular shower head</p>  <p>CC KK 462 601</p>	<p>TET-1214-91-xx 12" square built-in shower head</p>  <p>CC 763</p>	<p>BRA-1409-02-xx 15" L-shaped shower arm</p>  <p>CC KK LL BB 314 408 471 471</p>
<p>TET-1013-01-xx 10" round shower head</p>  <p>CC KK 416 541</p>	<p>TET-1613-01-xx 16" round shower head</p>  <p>CC 809</p>	<p>TET-2012-01-xx 20" x 12" rectangular shower head</p>  <p>CC 965</p>	<p>TET-1614-91-xx 16" square built-in shower head</p>  <p>CC 1006</p>	<p>BRA-1612-66-xx 16" shower arm</p>  <p>CC KK LL BB 179 233 269 269</p> <p>BRA-1815-02-xx 18" shower arm</p>  <p>CC KK LL BB 325 423 488 488</p>
<p>DGL-3080-83-xx 3-spray sliding shower bar</p>  <p>CC KK LL BB 759 987 1139 1139</p>	<p>DGL-4880-03-xx 3-spray sliding shower bar</p>  <p>CC KK LL BB 849 1104 1274 1274</p>	<p>DSP-2604-19-xx Hand shower on wall-mounted supply elbow</p>  <p>CC KK LL BB 492 639 738 738</p>	<p>RAC-9001-16-xx 1/2" F wall-mount supply elbow</p>  <p>CC KK LL BB 124 161 186 186</p>	<p>RAC-0618-02-xx 6" ceiling mount shower arm</p>  <p>CC KK LL BB 68 88 102 102</p>
<p>BEC-0520-46-xx Profile tub spout without diverter</p>  <p>CC KK LL BB 434 564 651 651</p>				

Actual products may differ from pictures. Actual products measures may differ from the measures shown. All USD prices are subject to change without notice. Effective as of August 2023.

COMPLETE SHOWER KITS

PRO-3950-56-Cx PRR-3950-56-Cx*

Complete thermostatic shower kit

CC	CB	CF
5075	5075	5075

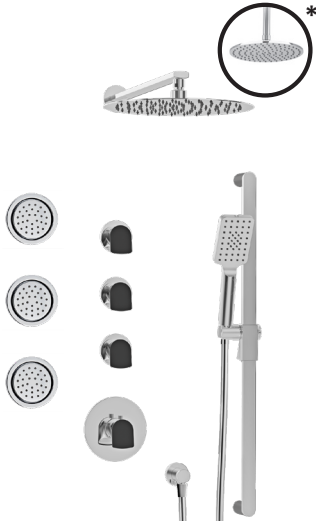

Features

- A- 3 accessories kit
- B- Max: 2 gpm - 80 psi (per accessory)
- C- 3-spray hand shower
- D- 59" PVC hose
- E- 3 accessories can work together

Includes

- B56-9404-00-Cx** Complete 3/4" thermostatic valve
- B56-9649-00-Cx** Complete 3/4" shut-off valve (3)
- TET-1213-01-CC** 12" round shower head
- BRA-1815-02-CC** 18" shower arm
- DGL-3080-83-CC** 3-spray sliding shower bar
- RAC-9001-16-CC** Elbow connector
- BOD-5007-01-CC** Built-in body jets (3)

TRIM ONLY

TRO-3950-56-Cx TRR-3950-56-Cx*

CC	CB	CF
3688	3688	3688

ROUGH VALVES Please order **all** of the following rough valves to complete the trim:

1x RVA-3404-00-B	Type T rough - 3/4" female NPT connections	682
3x RVA-2719-34-B	Volume control valve rough - 3/4" female NPT connections	235

PRO-4226-56-Cx PRR-4226-56-Cx*

Complete thermostatic pressure balanced shower kit

CC	CB	CF
2768	2768	2768



Features

- A- 2 accessories kit
- B- Max: 2 gpm - 80 psi (per accessory)
- C- 3-spray hand shower
- D- 59" PVC hose
- E- 2 accessories can work together

Includes

- B56-9521-00-Cx** Complete TP shower control valve with 2-way diverter
- TET-1213-01-CC** 12" round shower head
- BRA-1815-02-CC** 18" shower arm
- DGL-3080-83-CC** 3-spray sliding shower bar
- RAC-9001-16-CC** Wall-mount supply elbow

Ecological options	CEC	Codes	Features are the same, except:
		PRO-4226-56-Cx-NS	B- Max: 1.75 gpm - 80 psi (per accessory)
		TRO-4226-56-Cx-NS + RVA-9521-00-NS-B	E- 1 accessory works at a time

TRIM ONLY

TRO-4226-56-Cx TRR-4226-56-Cx*

CC	CB	CF
2083	2083	2083

ROUGH VALVES Please order **one** of the following rough valves to complete the trim:

RVA-9521-00-B	2-way TP rough - 1/2" male NPT or welded copper connections	685
RVA-9521-P0-B	2-way TP rough - PEX connections	685

Finishes:

CC = chrome, CB = chrome white, CF = smokey chrome
The products in this section are shown in smokey chrome.

* With 6" ceiling mount shower arm

ACCENT B56

PRO-4236-56-Cx PRR-4236-56-Cx*

Complete thermostatic pressure balanced shower kit

CC	CB	CF
3132	3132	3132

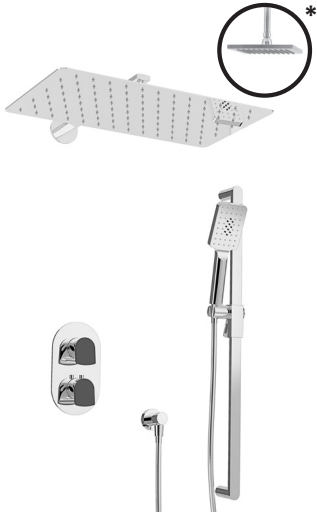

Features

- A- 2 accessories kit
- B- Max: 2 gpm - 80 psi (per accessory)
- C- 3-spray hand shower
- D- 59" PVC hose
- E- 2 accessories can work together

Includes

- B56-9521-00-Cx** Complete TP shower control valve with 2-way diverter
- TET-2012-01-CC** 20" x 12" rectangular shower head
- BRA-1815-02-CC** 18" shower arm
- DGL-3080-83-CC** 3-spray sliding shower bar
- RAC-9001-16-CC** Wall-mount supply elbow

Ecological options CEC

Codes

PRO-4236-56-Cx-NS
TRO-4236-56-Cx-NS + RVA-9521-00-NS-B

Features are the same, except:

B- Max: 1.75 gpm - 80 psi (per accessory)
E- 1 accessory works at a time

TRIM ONLY

TRO-4236-56-Cx TRR-4236-56-Cx*

CC	CB	CF
2447	2447	2447

ROUGH VALVES Please order **one** of the following rough valves to complete the trim:

RVA-9521-00-B

2-way TP rough - 1/2" male NPT or welded copper connections

685

RVA-9521-PO-B

2-way TP rough - PEX connections

685

PRO-4246-56-Cx

Complete thermostatic pressure balanced shower kit

CC	CB	CF
2975	2975	2975



Features

- A- 2 accessories kit
- B- Max: 2 gpm - 80 psi (per accessory)
- C- 3-spray hand shower
- D- 59" PVC hose
- E- Square built-in shower head
- F- 2 accessories can work together

Includes

- B56-9521-00-Cx** Complete TP shower control valve with 2-way diverter
- TET-1614-91-CC** 16" square built-in shower head
- DGL-3080-83-CC** 3-spray sliding shower bar
- RAC-9001-16-CC** Wall-mount supply elbow

Ecological options CEC

Codes

PRO-4246-56-Cx-NS
TRO-4246-56-Cx-NS + RVA-9521-00-NS-B

Features are the same, except:

B- Max: 1.75 gpm - 80 psi (per accessory)
F- 1 accessory works at a time

TRIM ONLY

TRO-4246-56-Cx

CC	CB	CF
2290	2290	2290

ROUGH VALVES Please order **one** of the following rough valves to complete the trim:

RVA-9521-00-B

2-way TP rough - 1/2" male NPT or welded copper connections

685

RVA-9521-PO-B

2-way TP rough - PEX connections

685

PRO-4255-56-Cx PRR-4255-56-Cx*

Complete thermostatic pressure balanced shower kit

CC	CB	CF
3075	3075	3075



Features

- A- 2 accessories kit
- B- Max: 2 gpm - 80 psi (per accessory)
- C- 3-spray hand shower
- D- 59" PVC hose
- E- 2 accessories can work together

Includes

- B56-9521-00-Cx** Complete TP shower control valve with 2-way diverter
- TET-1010-47-Cx** 10" Flora round shower head
- BRA-1815-02-CC** 18" shower arm
- DGL-3080-83-CC** 3-spray sliding shower bar
- RAC-9001-16-CC** Wall-mount supply elbow

Ecological options CEC

Codes

PRO-4255-56-Cx-NS
TRO-4255-56-Cx-NS + RVA-9521-00-NS-B

Features are the same, except:

B- Max: 1.75 gpm - 80 psi (per accessory)
E- 1 accessory works at a time

TRIM ONLY

TRO-4255-56-Cx TRR-4255-56-Cx*

CC	CB	CF
2390	2390	2390

ROUGH VALVES Please order **one** of the following rough valves to complete the trim:

RVA-9521-00-B

2-way TP rough - 1/2" male NPT or welded copper connections

685

RVA-9521-PO-B

2-way TP rough - PEX connections

685

ACCENT B56

PRO-4296-56-Cx PRR-4296-56-Cx*

Complete thermostatic shower kit

CC	CB	CF
2195	2195	2195

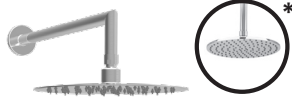

Features

- A- 2 accessories kit
- B- Max: 2 gpm - 80 psi (per accessory)
- C- 1-spray hand shower
- D- 2 accessories can work together

Includes

- B56-9521-00-Cx** Complete type TP shower valve with 2-way diverter
- TET-1013-01-CC** 10" round shower head
- BRA-1612-66-CC** 16" shower arm
- DSP-2604-19-CC** Hand shower on wall-mounted supply elbow

Ecological options CEC

Codes

PRO-4296-56-Cx-NS
TRO-4296-56-Cx-NS + RVA-9521-00-NS-B

Features are the same, except:

B- Max: 1.75 gpm - 80 psi (per accessory)
D- 1 accessory works at a time

TRIM ONLY

TRO-4296-56-Cx TRR-4296-56-Cx*

CC	CB	CF
1510	1510	1510

ROUGH VALVES Please order **one** of the following rough valves to complete the trim:

RVA-9521-00-B

2-way TP rough - 1/2" male NPT or welded copper connections

685

RVA-9521-PO-B

2-way TP rough - PEX connections

685

PRO-4326-56-Cx PRR-4326-56-Cx*

Complete thermostatic pressure balanced shower kit

CC	CB	CF
3288	3288	3288

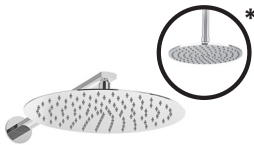

Features

- A- 3 accessories kit
- B- 8.5 gpm - 60 psi (bath spout)
- C- Max: 2 gpm - 80 psi (shower accessories)
- D- 3-spray hand shower
- E- 59" PVC hose
- F- 2 accessories can work together

Includes

- B56-9531-00-Cx** Complete TP shower control valve with 3-way diverter
- BEC-0520-46-CC** Profile tub spout without diverter
- TET-1213-01-CC** 12" round shower head
- BRA-1815-02-CC** 18" shower arm
- DGL-3080-83-CC** 3-spray sliding shower bar
- RAC-9001-16-CC** Wall-mount supply elbow

Ecological options CEC

Codes

PRO-4326-56-Cx-NS
TRO-4326-56-Cx-NS + RVA-9531-00-NS-B

Features are the same, except:

C- Max: 1.75 gpm - 80 psi (shower accessories)
F- 1 accessory works at a time

TRIM ONLY

TRO-4326-56-Cx TRR-4326-56-Cx*

CC	CB	CF
2493	2493	2493

ROUGH VALVES Please order **one** of the following rough valves to complete the trim:

RVA-9531-00-B

3-way TP rough - 1/2" male NPT or welded copper connections

795

RVA-9531-PO-B

3-way TP rough - PEX connections

795

Finishes:

CC = chrome, CB = chrome white, CF = smokey chrome
The products in this section are shown in smokey chrome.

* With 6" ceiling mount shower arm

ACCENT B56

SELECTION OF BATHROOM ACCESSORIES

For more bathroom accessories, please refer to the bathroom accessories section (see p. 293-306).

A56-1029-00-xx

ACCENT

Wall-mounted toilet paper holder



CC	KK	LL	BB	NN/YY	VV/TT	GG
226	294	339	339	294	361	497

A56-1069-00-xx

ACCENT

Bathrobe holder



CC	KK	LL	BB	NN/YY	VV/TT	GG
116	151	174	174	151	186	255

A56-6018-00-xx

ACCENT

18" single towel bar



CC	KK	LL	BB	NN/YY	VV/TT	GG
292	380	438	438	380	467	642

A56-6024-00-xx

ACCENT

24" single towel bar



CC	KK	LL	BB	NN/YY	VV/TT	GG
340	442	510	510	442	544	748

A56-6028-00-xx

ACCENT

28" single towel bar



CC	KK	LL	BB	NN/YY	VV/TT	GG
410	533	615	615	533	656	902

Actual products may differ from pictures. Actual products measures may differ from the measures shown. All USD prices are subject to change without notice. Effective as of August 2023.

ZIP B66

Compatible with the Touchless Sensor
Order ELE-2001-01-xx (p. 43)



BARIL

ZIP B66

B66-1005-1PL-xx

DRAIN INCLUDED

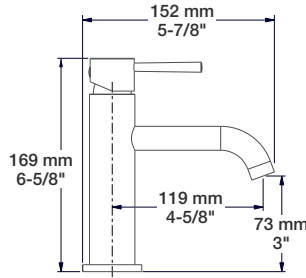

DRAIN NOT INCLUDED

B66-1005-00L-xx

C- Order your lavatory drain (pages 309-310)

THE ESSENTIALS

CC	KK	LL	BB	NN/YY	VV/TT	GG
476	619	714	714	619	762	1048

Single-hole lavatory faucet, drain included

- A- Max: 1.5 gpm - 60 psi
- B- CAR-1025-09
- C- Push-button drain with overflow included

Ecological options

Codes	Reduced flow rates
B66-1005-XXL-xx-120	1.2 gpm (4.5 l/min) - 60 psi
B66-1005-XXL-xx-100	1.0 gpm (3.7 l/min) - 60 psi
B66-1005-XXL-xx-050	0.5 gpm (1.9 l/min) - 60 psi

CC	KK	LL	BB	NN/YY	VV/TT	GG
428	556	642	642	556	685	937

B66-1010-1PL-xx

DRAIN INCLUDED

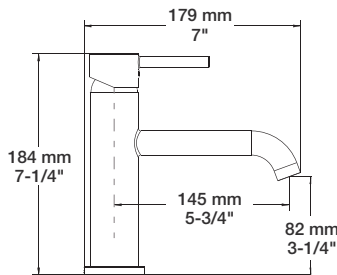

DRAIN NOT INCLUDED

B66-1010-01L-xx

C- Order your lavatory drain (pages 309-310)

THE ESSENTIALS

CC	KK	LL	BB	NN/YY	VV/TT	GG
491	638	737	737	638	786	1080

Single-hole lavatory faucet, drain included

- A- Max: 1.5 gpm - 60 psi
- B- CAR-1031-49
- C- Push-button drain with overflow included

Ecological options

Codes	Reduced flow rates
B66-1010-XXL-xx-120	1.2 gpm (4.5 l/min) - 60 psi
B66-1010-XXL-xx-100	1.0 gpm (3.7 l/min) - 60 psi
B66-1010-XXL-xx-050	0.5 gpm (1.9 l/min) - 60 psi

CC	KK	LL	BB	NN/YY	VV/TT	GG
443	575	665	665	575	709	969

B66-1020-00L-xx

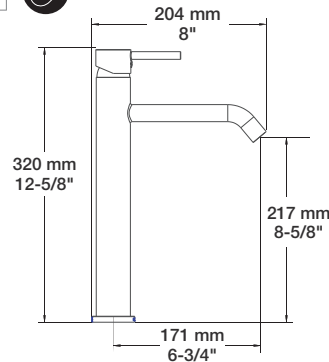

DRAIN NOT INCLUDED

B66-1010-01L-xx

C- Order your lavatory drain (pages 309-310)

CC	KK	LL	BB	NN/YY	VV/TT	GG
607	789	910	910	789	971	1335

High single-hole lavatory faucet, drain not included

- A- Max: 1.5 gpm - 60 psi
- B- Order your lavatory drain (pages 309-310)
- C- CAR-1031-49

Ecological options

Codes	Reduced flow rates
B66-1020-00L-xx-120	1.2 gpm (4.5 l/min) - 60 psi
B66-1020-00L-xx-100	1.0 gpm (3.7 l/min) - 60 psi
B66-1020-00L-xx-050	0.5 gpm (1.9 l/min) - 60 psi

CC	KK	LL	BB	NN/YY	VV/TT	GG
708	920	1062	1062	920	1133	1558

B66-1030-1PL-xx

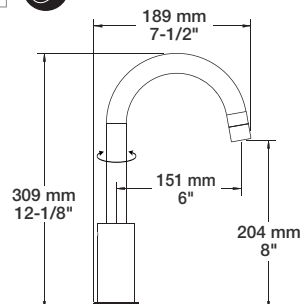

DRAIN NOT INCLUDED

B66-1030-00L-xx

B- Order your lavatory drain (pages 309-310)

Single-hole lavatory faucet, drain included

- A- Max: 1.5 gpm - 60 psi
- B- Push-button drain with overflow included
- C- Adjustable aerator
- D- CAR-1031-49

Ecological options

Codes	Reduced flow rates
B66-1030-XXL-xx-120	1.2 gpm (4.5 l/min) - 60 psi
B66-1030-XXL-xx-100	1.0 gpm (3.7 l/min) - 60 psi
B66-1030-XXL-xx-050	0.5 gpm (1.9 l/min) - 60 psi

CC	KK	LL	BB	NN/YY	VV/TT	GG
660	857	990	990	857	1056	1447

Actual products may differ from pictures. Actual products measures may differ from the measures shown. All USD prices are subject to change without notice. Effective as of August 2023.

ZIP B66

THE ESSENTIALS

B66-8009-00L-xx

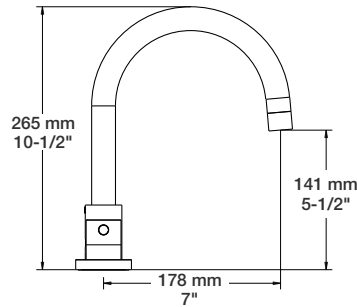

CC	KK	LL	BB	NN/YY	VV/TT	GG
819	1064	1228	1228	1064	1310	1801

8" c/c lavatory faucet, drain included

- A- Max: 1.5 gpm - 60 psi
- B- Push-button drain with overflow included
- C- Adjustable aerator
- D- Swivel spout
- E- CAR-1020-01 (Cold), CAR-1020-02 (Hot)

Ecological options

Codes	Reduced flow rates	CEC
B66-8009-00L-xx-120	1.2 gpm (4.5 l/min) - 60 psi	
B66-8009-00L-xx-100	1.0 gpm (3.7 l/min) - 60 psi	
B66-8009-00L-xx-050	0.5 gpm (1.9 l/min) - 60 psi	

B66-8029-00L-xx



Available Q3 2023

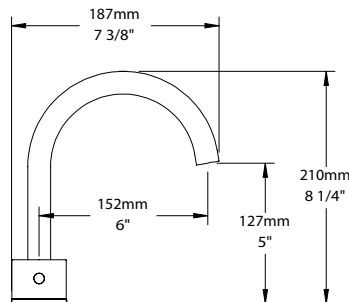

CC	KK	LL	BB	NN/YY	VV/TT	GG
949	1234	1424	1424	1234	1518	2088

8" c/c lavatory faucet, drain included

- A- Max: 1.5 gpm - 60 psi
- B- Push-button drain with overflow included
- C- Adjustable aerator
- D- CAR-3820-01 (Cold), CAR-3820-02 (Hot)

Ecological options

Codes	Reduced flow rates	CEC
B66-8029-00L-xx-120	1.2 gpm (4.5 l/min) - 60 psi	
B66-8029-00L-xx-100	1.0 gpm (3.7 l/min) - 60 psi	
B66-8029-00L-xx-050	0.5 gpm (1.9 l/min) - 60 psi	

B66-8100-02L-xx

COMPLETE FAUCET

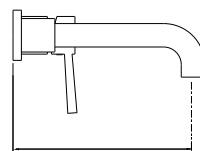
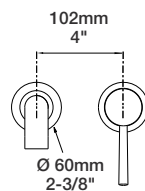

CC	KK	LL	BB	NN/YY	VV/TT	GG
722	939	1083	1083	939	1155	1588

Single lever wall-mounted lavatory faucet, drain not included

- A- Max: 1.5 gpm - 60 psi
- B- Order your lavatory drain (pages 309-310)
- C- Adjustable aerator
- D- One-piece rough for easy installation
- E- CAR-1031-49

Ecological options

Codes	Reduced flow rates	CEC
B66-8100-02L-xx-120	1.2 gpm (4.5 l/min) - 60 psi	
B66-8100-02L-xx-100	1.0 gpm (3.7 l/min) - 60 psi	
B66-8100-02L-xx-050	0.5 gpm (1.9 l/min) - 60 psi	



TRIM ONLY

T66-8100-03L-xx

CC	KK	LL	BB	NN/YY	VV/TT	GG
346	552	690	690	552	759	1172

ROUGH Please order the following rough to complete the trim:

ROU-8100-03-B

Single lever wall-mounted lavatory rough - 1/2" male NPT or welded copper connections

342

Finishes:

CC = chrome, KK = matte black, LL = satin brass, BB = white, NN = brushed nickel, YY = polished nickel, TT = venetian bronze, VV = satin copper, GG = gold 197

ZIP B66

THE ESSENTIALS

B66-8100-04L-XX

COMPLETE FAUCET

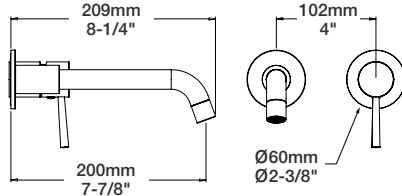

CC	KK	LL	BB	NN/YY	VV/TT	GG
722	939	1083	1083	939	1155	1588

Single lever wall-mounted lavatory faucet, drain not included

- A- Max: 1.5 gpm - 60 psi
- B- Order your lavatory drain (pages 309-310)
- C- Adjustable aerator
- D- Sleeve on the spout is optional: 2 choices of installation
- E- One-piece rough for easy installation
- F- Large depth adjustment range
- G- CAR-1025-09

Ecological options

Codes	Reduced flow rates	CEC
B66-8100-04L-xx-120	1.2 gpm (4.5 l/min) - 60 psi	
B66-8100-04L-xx-100	1.0 gpm (3.7 l/min) - 60 psi	
B66-8100-04L-xx-050	0.5 gpm (1.9 l/min) - 60 psi	

TRIM ONLY

T66-8100-04L-xx

CC	KK	LL	BB	NN/YY	VV/TT	GG
380	597	741	741	597	814	1247

ROUGH Please order the following rough to complete the trim:

ROU-8100-04-B

Single lever wall-mounted lavatory rough - 1/2" male NPT or welded copper connections

342

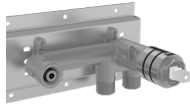

B66-8120-04L-XX

COMPLETE FAUCET

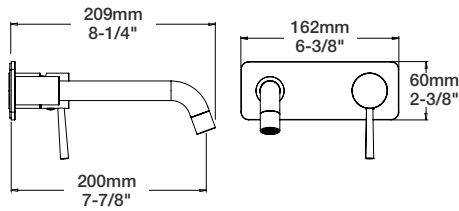
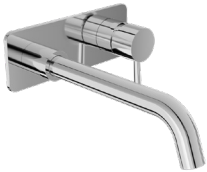

CC	KK	LL	BB	NN/YY	VV/TT	GG
804	1045	1205	1205	1045	1286	1768

Single lever wall-mounted lavatory faucet, drain not included

- A- Max: 1.5 gpm - 60 psi
- B- Order your lavatory drain (pages 309-310)
- C- Adjustable aerator
- D- Sleeve on the spout is optional: 2 choices of installation
- E- One-piece rough for easy installation
- F- Large depth adjustment range
- G- CAR-1025-09

Ecological options

Codes	Reduced flow rates	CEC
B66-8120-04L-xx-120	1.2 gpm (4.5 l/min) - 60 psi	
B66-8120-04L-xx-100	1.0 gpm (3.7 l/min) - 60 psi	
B66-8120-04L-xx-050	0.5 gpm (1.9 l/min) - 60 psi	

TRIM ONLY

T66-8120-04L-xx

CC	KK	LL	BB	NN/YY	VV/TT	GG
462	703	863	863	703	944	1426

ROUGH Please order the following rough to complete the trim:

ROU-8100-04-B

Single lever wall-mounted lavatory rough - 1/2" male NPT or welded copper connections

342

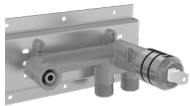

Actual products may differ from pictures. Actual products measures may differ from the measures shown. All USD prices are subject to change without notice. Effective as of August 2023.

THE ESSENTIALS

B66-1100-02-xx

COMPLETE FAUCET ADA

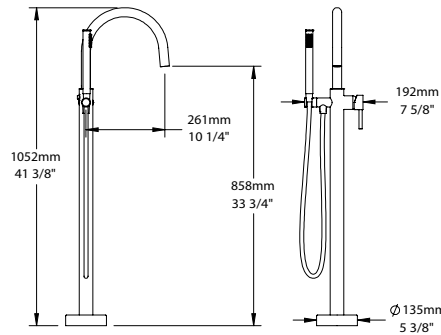

CC	KK	LL	BB	NN/YY	VV/TT	GG
2032	2642	3048	3048	2642	3251	4470

Floor-mounted tub filler with hand shower

Bath spout:

- A- 6.3 gpm - 60 psi
- B- Tub spout with integrated push-button diverter
- C- Swivel spout

Hand shower:

- D- Max: 2 gpm - 80 psi
- E- Reclining hand shower holder
- F- DOU-2604-01-xx
- G- 59" PVC hose in KK finish or brass for other finishes
- H- CAR-1060-01

Ecological options

Codes	Reduced flow rates
B66-1100-02-xx-150	1.5 gpm (5.7 l/min) - 80 psi
B66-1100-02-xx-175	1.75 gpm (6.6 l/min) - 80 psi

TRIM ONLY

T66-1100-02-xx



CC	KK	LL	BB	NN/YY	VV/TT	GG
1897	2507	2913	2913	2507	3116	4335

MOUNTING KIT Please order the following kit to complete the trim:

FIX-1100-00-B

Floor mounting kit for floor-mounted tub filler with hand shower

135

THE ESSENTIALS

B66-1249-00-xx

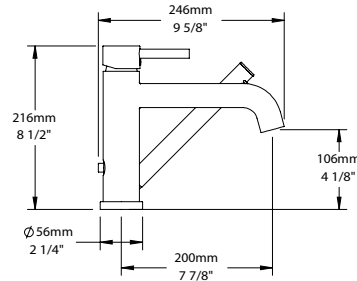

CC	KK	LL	BB	NN/YY	VV/TT	GG
1075	1398	1613	1613	1398	1720	2365

2-piece tub filler with hand shower

Bath spout:

- A- 8.4 gpm - 60 psi
- B- Tub spout with integrated push-button diverter

Hand shower:

- C- Max: 2 gpm - 80 psi
- D- DOU-2604-01-xx
- E- CAR-1060-01

Ecological options

Codes	Reduced flow rates
B66-1249-00-xx-150	1.5 gpm (5.7 l/min) - 80 psi
B66-1249-00-xx-175	1.75 gpm (6.6 l/min) - 80 psi

B66-1369-03-xx

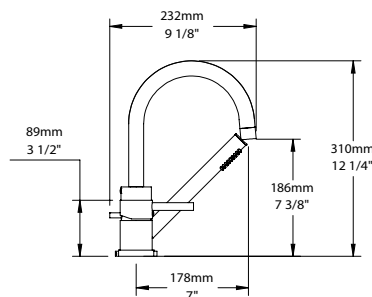

CC	KK	LL	BB	NN/YY	VV/TT	GG
1195	1554	1793	1793	1554	1912	2629

3-piece tub filler with hand shower

Bath spout:

- A- 6.9 gpm - 60 psi
- B- Swivel tub spout with integrated push-button diverter

Hand shower:

- C- Max: 2 gpm - 80 psi
- D- Hand shower - 2 choices of installation
- E- DOU-2604-01-xx
- F- CAR-1060-01

Ecological options

Codes	Reduced flow rates
B66-1369-03-xx-150	1.5 gpm (5.7 l/min) - 80 psi
B66-1369-03-xx-175	1.75 gpm (6.6 l/min) - 80 psi

Finishes:

CC = chrome, KK = matte black, LL = satin brass, BB = white, NN = brushed nickel, YY = polished nickel, TT = venetian bronze, VV = satin copper, GG = gold 199

ZIP B66

B66-1600-00-xx

COMPLETE FAUCET

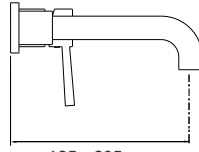
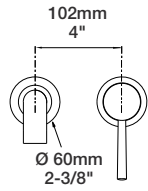

CC	KK	LL	BB	NN/YY	VV/TT	GG
959	1246	1438	1438	1246	1534	2109

Wall-mounted tub faucet

- A- 5.3 gpm - 60 psi
- B- One-piece rough for easy installation
- C- CAR-1031-49

TRIM ONLY

T66-1600-00-xx

CC	KK	LL	BB	NN/YY	VV/TT	GG
617	904	1096	1096	904	1192	1767

ROUGH Please order the following rough to complete the trim:

ROU-1600-03-B

Wall-mounted tub faucet rough - 1/2" male NPT or welded copper connections

342



B66-2001-XX-xx

COMPLETE FAUCET

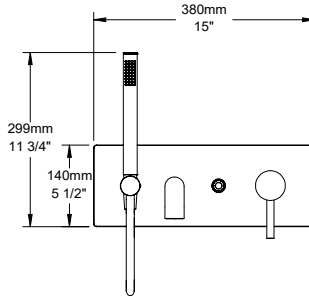
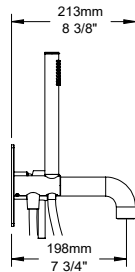
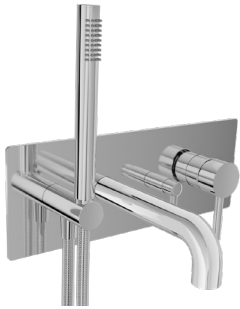

Wall-mounted tub faucet with hand shower

Hand shower:

- A- Max: 2 gpm - 80 psi
- B- Robust and easy-to-use push-button diverter
- C- Push-button can be locked in the engaged position
- D- Easy to install one-piece rough
- E- DOU-2604-01-xx
- F- PVC hose in KK finish or brass for other finishes

Ecological options

Codes	Reduced flow rates
B66-2001-XX-xx-150	1.5 gpm (5.7 l/min) - 80 psi
B66-2001-XX-xx-175	1.75 gpm (6.6 l/min) - 80 psi

CEC

REGULAR VERSION

B66-2001-00-xx

Bath spout: 6.6 gpm - 60 psi
Cartridge: CAR-1060-01

CC	KK	LL	BB	NN/YY	VV/TT	GG
1972	2564	2958	2958	2564	3155	4338

TRIM ONLY

T66-2001-00-xx

Cartridge included with the trim

CC	KK	LL	BB	NN/YY	VV/TT	GG
1410	2002	2396	2396	2002	2593	3776

ROUGH VALVE

ROU-2000-99-B

Wall-mounted tub faucet rough (without cartridge)- 1/2" female NPT connections

562



PRESSURE BALANCED VERSION

B66-2001-PB-xx

Bath spout: 6.1 gpm - 60 psi
Cartridge: CAR-1060-01

P-type faucet can be set to 120.2 °F

CC	KK	LL	BB	NN/YY	VV/TT	GG
1972	2564	2958	2958	2564	3155	4338

TRIM ONLY

T66-2001-PB-xx

Cartridge included with the trim

CC	KK	LL	BB	NN/YY	VV/TT	GG
1410	2002	2396	2396	2002	2593	3776

ROUGH VALVE

ROU-2000-99-B

Wall-mounted tub faucet rough (without cartridge)- 1/2" female NPT connections

562



Actual products may differ from pictures. Actual products measures may differ from the measures shown. All USD prices are subject to change without notice. Effective as of August 2023.

B66-9120-00-xx

ROUGH & TRIM PACKAGE

CC	KK	LL	BB	NN/YY	VV/TT	GG
539	608	654	654	608	676	814

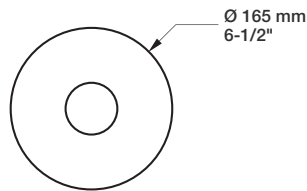

Complete pressure balanced shower control valve

- A- 6 gpm - 60 psi
- B- Volume control valve
- C- CAR-1020-40
- D- Rough valve RVA-9020-00-B included

TRIM ONLY

T66-9139-00-xx

CC	KK	LL	BB	NN/YY	VV/TT	GG
229	298	344	344	298	366	504

ROUGH VALVES Please order **one** of the following rough valves to complete the trim:

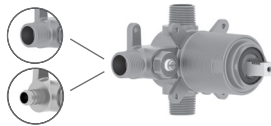

RVA-9020-00-B

Type P rough - 1/2" male NPT or welded copper connections

310

RVA-9020-P0-B

Type P rough - PEX connections

310

THE ESSENTIALS

B66-9181-00-xx

ROUGH & TRIM PACKAGE

CC	KK	LL	BB	NN/YY	VV/TT	GG
773	863	923	923	863	952	1132

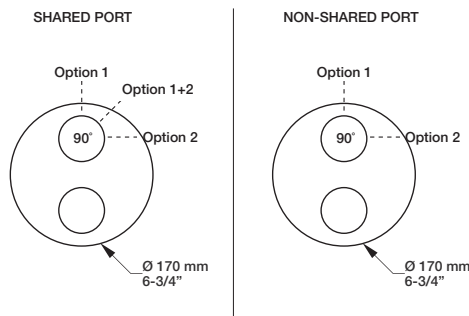

Complete pressure balanced shower control valve with 2-way diverter (shared port)

- A- 1 outlet: 5 gpm - 60 psi, 2 outlets: 2.6 gpm - 60 psi
- B- Volume control valve
- C- Up to 2 accessories can be used at the same time
- D- CAR-1020-40 (volume), CAR-1001-35 (diverter)
- E- Rough valve RVA-9181-00-B included

Ecological options CEC

Codes	Features
B66-9181-00-xx-NS	Non-shared port
T66-9181-00-xx + RVA-9181-00-NS-B	1 accessory works at a time
T66-9181-00-xx + RVA-9181-P0-NS-B	CAR-1001-35-NS (diverter)

TRIM ONLY

T66-9181-00-xx

CC	KK	LL	BB	NN/YY	VV/TT	GG
299	389	449	449	389	478	658

ROUGH VALVES Please order **one** of the following rough valves to complete the trim:

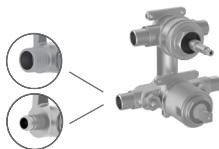

RVA-9181-00-B

2-way type P rough - 1/2" male NPT or welded copper connections

474

RVA-9181-P0-B

2-way type P rough - PEX connections

474

Finishes:

CC = chrome, KK = matte black, LL = satin brass, BB = white, NN = brushed nickel, YY = polished nickel, TT = venetian bronze, VV = satin copper, GG = gold **201**

ZIP B66

B66-9190-00-xx

ROUGH & TRIM PACKAGE

CC	KK	LL	BB	NN/YY	VV/TT	GG
828	918	978	978	918	1007	1187

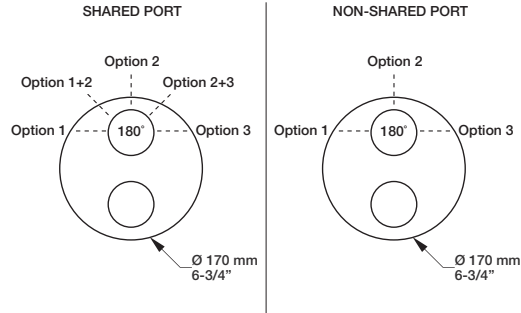

Complete pressure balanced shower control valve with 3-way diverter (shared port)

- A- 1 outlet: 5 gpm - 60 psi, 2 outlets: 2.6 gpm - 60 psi
- B- Volume control valve
- C- Up to 2 accessories can be used at the same time
- D- CAR-1020-40 (volume), CAR-9220-02 (diverter)
- E- Rough valve RVA-9191-00-B included

Ecological options CEC

Codes	Features
B66-9190-00-xx-NS	Non-shared port
T66-9190-00-xx + RVA-9191-00-NS-B	1 accessory works at a time
T66-9190-00-xx + RVA-9191-PO-NS-B	CAR-9220-02-NS (diverter)

TRIM ONLY

T66-9190-00-xx

CC	KK	LL	BB	NN/YY	VV/TT	GG
299	389	449	449	389	478	658

ROUGH VALVES Please order **one** of the following rough valves to complete the trim:

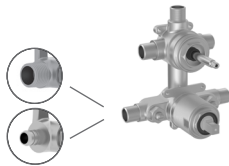

RVA-9191-00-B

3-way type P rough - 1/2" male NPT or welded copper connections

529

RVA-9191-PO-B

3-way type P rough - PEX connections

529

B66-9404-00-xx

ROUGH & TRIM PACKAGE

CC	KK	LL	BB	NN/YY	VV/TT	GG
1127	1261	1350	1350	1261	1394	1661

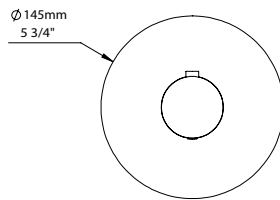

Complete 3/4" thermostatic valve

- A- 16 gpm - 60 psi
- B- Separate volume control or diverter valve required
- C- Can easily supply 3 accessories
- D- Thin brass plate
- E- CAR-3404-00
- F- Rough valve RVA-3404-00-B included
- G- Reversible check / non-return valves in case of water supply inversion

TRIM ONLY

T66-9404-00-xx

CC	KK	LL	BB	NN/YY	VV/TT	GG
445	579	668	668	579	712	979

ROUGH VALVE Please order the following rough valve to complete the trim:



RVA-3404-00-B

Type T rough - 3/4" female NPT connections

682

B66-9453-00-xx

ROUGH & TRIM PACKAGE

CC	KK	LL	BB	NN/YY	VV/TT	GG
1094	1228	1317	1317	1228	1361	1628

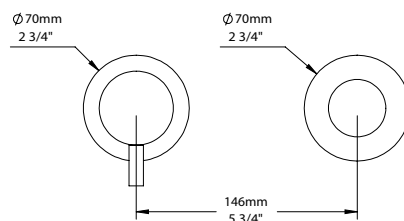

Complete 3/4" thermostatic valve

- A- 9 gpm - 60 psi
- B- Separate volume control or diverter valve required
- C- Can easily supply 3 accessories
- D- Hook on the side of the valve can be removed to give access to the check valves
- E- Reversible check / non-return valves in case of water supply inversion
- F- CAR-2661-00
- G- Rough valve RVA-3453-00-B included
- H- Large depth adjustment range

TRIM ONLY

T66-9453-00-xx

CC	KK	LL	BB	NN/YY	VV/TT	GG
445	579	668	668	579	712	979

ROUGH VALVE Please order the following rough valve to complete the trim:



RVA-3453-00-B

Type T rough - 3/4" female NPT connections

649

Actual products may differ from pictures. Actual products measures may differ from the measures shown. All USD prices are subject to change without notice. Effective as of August 2023.

THE ESSENTIALS

B66-9521-00-xx

ROUGH & TRIM PACKAGE

CC	KK	LL	BB	NN/YY	VV/TT	GG
1069	1184	1261	1261	1184	1299	1530

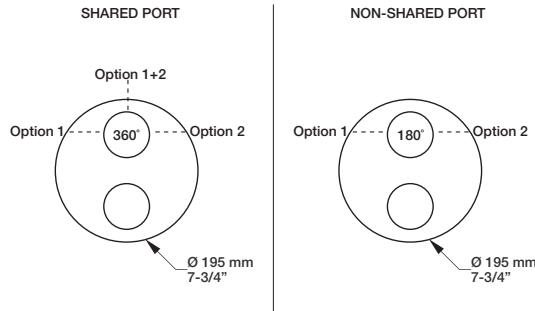

Complete thermostatic pressure balanced shower control valve with 2-way diverter (shared port)

- A- 1 outlet: 7.9 gpm - 60 psi, 2 outlets: 3.7 gpm - 60 psi
- B- Up to 2 accessories can be used at the same time
- C- Thin brass plate
- D- Reversible check / non-return valves in case of water supply inversion
- E- CAR-2661-00 (temperature), CAR-3003-36 (diverter)
- F- Rough valve RVA-9521-00-B included
- G- Large depth adjustment range

Ecological options **CEC**

Codes	Features
B66-9521-00-xx-NS	Non-shared port
T66-9521-00-xx + RVA-9521-00-NS-B	1 accessory works at a time
T66-9521-00-xx + RVA-9521-PO-NS-B	CAR-3003-36-NS (diverter)

TRIM ONLY

T66-9521-00-xx

CC	KK	LL	BB	NN/YY	VV/TT	GG
384	499	576	576	499	614	845

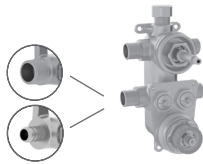

ROUGH VALVES Please order **one** of the following rough valves to complete the trim:

RVA-9521-00-B	2-way TP rough - 1/2" male NPT or welded copper connections	685
RVA-9521-PO-B	2-way TP rough - PEX connections	685

THE ESSENTIALS

B66-9531-00-xx

ROUGH & TRIM PACKAGE

CC	KK	LL	BB	NN/YY	VV/TT	GG
1179	1294	1371	1371	1294	1409	1640

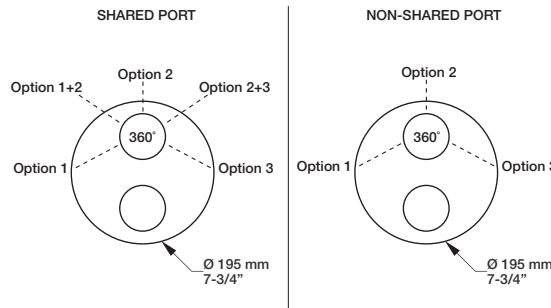

Complete thermostatic pressure balanced shower control valve with 3-way diverter (shared port)

- A- 1 outlet: 7.9 gpm - 60 psi, 2 outlets: 3.7 gpm - 60 psi
- B- Up to 2 accessories can be used at the same time
- C- Thin brass plate
- D- Reversible check / non-return valves in case of water supply inversion
- E- CAR-2661-00 (temperature), CAR-9531-03 (diverter)
- F- Rough valve RVA-9531-00-B included
- G- Large depth adjustment range

Ecological options **CEC**

Codes	Features
B66-9531-00-xx-NS	Non-shared port
T66-9531-00-xx + RVA-9531-00-NS-B	1 accessory works at a time
T66-9531-00-xx + RVA-9531-PO-NS-B	CAR-9531-03-NS (diverter)

TRIM ONLY

T66-9531-00-xx

CC	KK	LL	BB	NN/YY	VV/TT	GG
384	499	576	576	499	614	845

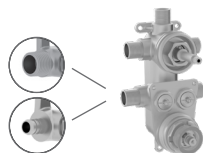

ROUGH VALVES Please order **one** of the following rough valves to complete the trim:

RVA-9531-00-B	3-way TP rough - 1/2" male NPT or welded copper connections	795
RVA-9531-PO-B	3-way TP rough - PEX connections	795

Finishes:

CC = chrome, KK = matte black, LL = satin brass, BB = white, NN = brushed nickel, YY = polished nickel, TT = venetian bronze, VV = satin copper, GG = gold **203**

ZIP B66

B66-9560-02-xx

ROUGH & TRIM PACKAGE

CC	KK	LL	BB	NN/YY	VV/TT	GG
487	543	581	581	543	600	713

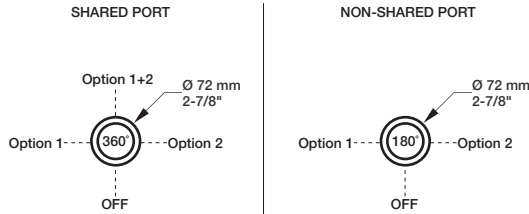

Complete 2-port diverter with stop (shared port)

- A- 1 outlet: 10.5 gpm – 60 psi, 2 outlets: 4 gpm – 60 psi
- B- Can replace 2 volume control valves
- C- Up to 2 accessories can be used at the same time
- D- CAR-9525-02
- E- Rough RVA-9562-00-B included
- F- Extra long cartridge for maximum adjustment

Ecological options cec

Codes	Features
B66-9560-02-xx-NS	Non-shared port
T66-9560-02-xx + RVA-9562-00-NS-B	1 accessory works at a time CAR-9525-02-NS (diverter)

TRIM ONLY

T66-9560-02-xx

CC	KK	LL	BB	NN/YY	VV/TT	GG
188	244	282	282	244	301	414

ROUGH VALVE Please order the following rough valve to complete the trim:

RVA-9562-00-B

2-port diverter rough - 1/2" male NPT or welded copper connections

299



B66-9560-03-xx

ROUGH & TRIM PACKAGE

CC	KK	LL	BB	NN/YY	VV/TT	GG
569	625	663	663	625	682	795

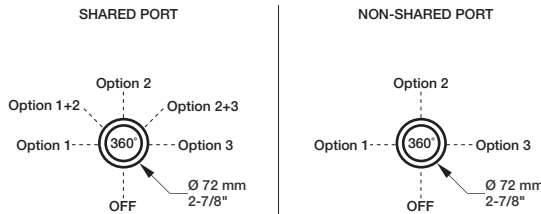

Complete 3-port diverter with stop (shared port)

- A- 1 outlet: 9.7 gpm – 60 psi, 2 outlets: 5.2 gpm – 60 psi
- B- Can replace 2 or 3 volume control valves
- C- Up to 2 accessories can be used at the same time
- D- CAR-9530-03
- E- Rough RVA-9563-00-B included
- F- Extra long cartridge for maximum adjustment

Ecological options cec

Codes	Features
B66-9560-03-xx-NS	Non-shared port
T66-9560-03-xx + RVA-9563-00-NS-B	1 accessory works at a time CAR-9530-03-NS (diverter)

TRIM ONLY

T66-9560-03-xx

CC	KK	LL	BB	NN/YY	VV/TT	GG
188	244	282	282	244	301	414

ROUGH VALVE Please order the following rough valve to complete the trim:

RVA-9563-00-B

3-port diverter rough - inlet: 3/4" F NPT - outlets: 1/2" F NPT

381



B66-9600-00-xx

ROUGH & TRIM PACKAGE

CC	KK	LL	BB	NN/YY	VV/TT	GG
362	418	456	456	418	475	588

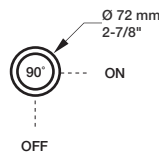

Complete 1/2" volume control valve

- A- 7.9 gpm - 60 psi
- B- Volume control valve
- C- CAR-1011-81
- D- Rough valve RVA-2020-01-B included
- E- Extra long cartridge for maximum adjustment

TRIM ONLY

T66-9600-00-xx

CC	KK	LL	BB	NN/YY	VV/TT	GG
188	244	282	282	244	301	414

ROUGH VALVE Please order the following rough valve to complete the trim:

RVA-2020-01-B

Volume control valve rough - 1/2" female NPT connections

174

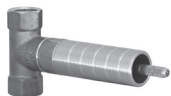

Actual products may differ from pictures. Actual products measures may differ from the measures shown. All USD prices are subject to change without notice. Effective as of August 2023.

B66-9649-00-xx

ROUGH & TRIM PACKAGE

CC	KK	LL	BB	NN/YY	VV/TT	GG
423	479	517	517	479	536	649

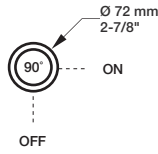

Complete 3/4" volume control valve

- A- 11.1 gpm - 60 psi
- B- Volume control valve
- C- Offers a larger flow
- D- CAR-2719-34
- E- Rough valve RVA-2719-34-B included
- F- Extra long cartridge for maximum adjustment



TRIM ONLY

T66-9649-00-xx

CC	KK	LL	BB	NN/YY	VV/TT	GG
188	244	282	282	244	301	414

ROUGH VALVE Please order the following rough valve to complete the trim:

RVA-2719-34-B

Volume control valve rough - 3/4" female NPT connections

235















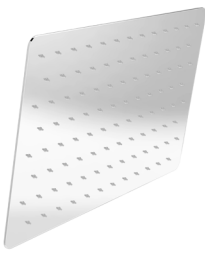

Finishes:

CC = chrome, KK = matte black, LL = satin brass, BB = white, NN = brushed nickel, YY = polished nickel, TT = venetian bronze, VV = satin copper, GG = gold **205**

ZIP B66

SELECTION OF SHOWER COMPONENTS

For more shower components and for ecological options, please refer to the shower components section (see p. 347-382).

<p>TET-0810-01-xx 8" round shower head</p>  <table border="1"> <thead> <tr> <th>CC</th> <th>KK</th> <th>LL</th> <th>BB</th> </tr> </thead> <tbody> <tr> <td>445</td> <td>579</td> <td>668</td> <td>668</td> </tr> </tbody> </table>	CC	KK	LL	BB	445	579	668	668	<p>TET-1010-01-xx 10" round shower head</p>  <table border="1"> <thead> <tr> <th>CC</th> <th>KK</th> <th>LL</th> <th>BB</th> </tr> </thead> <tbody> <tr> <td>575</td> <td>748</td> <td>863</td> <td>863</td> </tr> </tbody> </table>	CC	KK	LL	BB	575	748	863	863	<p>TET-1213-01-xx 12" round shower head</p>  <table border="1"> <thead> <tr> <th>CC</th> </tr> </thead> <tbody> <tr> <td>572</td> </tr> </tbody> </table>	CC	572	<p>TET-1208-01-xx 12" x 8" rectangular shower head</p>  <table border="1"> <thead> <tr> <th>CC</th> <th>KK</th> </tr> </thead> <tbody> <tr> <td>462</td> <td>601</td> </tr> </tbody> </table>	CC	KK	462	601	<p>BRA-1612-66-xx 16" shower arm</p>  <table border="1"> <thead> <tr> <th>CC</th> <th>KK</th> <th>LL</th> <th>BB</th> </tr> </thead> <tbody> <tr> <td>179</td> <td>233</td> <td>269</td> <td>269</td> </tr> </tbody> </table>	CC	KK	LL	BB	179	233	269	269										
CC	KK	LL	BB																																									
445	579	668	668																																									
CC	KK	LL	BB																																									
575	748	863	863																																									
CC																																												
572																																												
CC	KK																																											
462	601																																											
CC	KK	LL	BB																																									
179	233	269	269																																									
<p>TET-0813-01-xx 8" round shower head</p>  <table border="1"> <thead> <tr> <th>CC</th> </tr> </thead> <tbody> <tr> <td>310</td> </tr> </tbody> </table>	CC	310	<p>TET-1013-01-xx 10" round shower head</p>  <table border="1"> <thead> <tr> <th>CC</th> <th>KK</th> </tr> </thead> <tbody> <tr> <td>416</td> <td>541</td> </tr> </tbody> </table>	CC	KK	416	541	<p>TET-1613-01-xx 16" round shower head</p>  <table border="1"> <thead> <tr> <th>CC</th> </tr> </thead> <tbody> <tr> <td>809</td> </tr> </tbody> </table>	CC	809	<p>TET-2012-01-xx 20" x 12" rectangular shower head</p>  <table border="1"> <thead> <tr> <th>CC</th> </tr> </thead> <tbody> <tr> <td>965</td> </tr> </tbody> </table>	CC	965	<p>BRA-1815-02-xx 18" shower arm</p>  <table border="1"> <thead> <tr> <th>CC</th> <th>KK</th> <th>LL</th> <th>BB</th> </tr> </thead> <tbody> <tr> <td>325</td> <td>423</td> <td>488</td> <td>488</td> </tr> </tbody> </table>	CC	KK	LL	BB	325	423	488	488																						
CC																																												
310																																												
CC	KK																																											
416	541																																											
CC																																												
809																																												
CC																																												
965																																												
CC	KK	LL	BB																																									
325	423	488	488																																									
<p>DGL-2175-52-xx 3-spray sliding shower bar with built-in supply elbow</p>  <table border="1"> <thead> <tr> <th>CC</th> <th>KK</th> <th>LL</th> <th>BB</th> </tr> </thead> <tbody> <tr> <td>543</td> <td>706</td> <td>815</td> <td>815</td> </tr> </tbody> </table>	CC	KK	LL	BB	543	706	815	815	<p>DGL-2175-53-xx 3-spray sliding shower bar</p>  <table border="1"> <thead> <tr> <th>CC</th> <th>KK</th> <th>LL</th> <th>BB</th> </tr> </thead> <tbody> <tr> <td>468</td> <td>608</td> <td>702</td> <td>702</td> </tr> </tbody> </table>	CC	KK	LL	BB	468	608	702	702	<p>DSP-2566-19-xx Hand shower on wall-mounted supply elbow</p>  <table border="1"> <thead> <tr> <th>CC</th> <th>KK</th> <th>LL</th> <th>BB</th> </tr> </thead> <tbody> <tr> <td>423</td> <td>550</td> <td>635</td> <td>635</td> </tr> </tbody> </table>	CC	KK	LL	BB	423	550	635	635	<p>DSP-2604-19-xx Hand shower on wall-mounted supply elbow</p>  <table border="1"> <thead> <tr> <th>CC</th> <th>KK</th> <th>LL</th> <th>BB</th> </tr> </thead> <tbody> <tr> <td>492</td> <td>639</td> <td>738</td> <td>738</td> </tr> </tbody> </table>	CC	KK	LL	BB	492	639	738	738	<p>RAC-9001-16-xx 1/2" F wall-mount supply elbow</p>  <table border="1"> <thead> <tr> <th>CC</th> <th>KK</th> <th>LL</th> <th>BB</th> </tr> </thead> <tbody> <tr> <td>124</td> <td>161</td> <td>186</td> <td>186</td> </tr> </tbody> </table>	CC	KK	LL	BB	124	161	186	186
CC	KK	LL	BB																																									
543	706	815	815																																									
CC	KK	LL	BB																																									
468	608	702	702																																									
CC	KK	LL	BB																																									
423	550	635	635																																									
CC	KK	LL	BB																																									
492	639	738	738																																									
CC	KK	LL	BB																																									
124	161	186	186																																									
<p>BEC-0520-37-xx Round modern tub spout without diverter</p>  <table border="1"> <thead> <tr> <th>CC</th> <th>KK</th> <th>LL</th> <th>BB</th> </tr> </thead> <tbody> <tr> <td>219</td> <td>285</td> <td>329</td> <td>329</td> </tr> </tbody> </table>	CC	KK	LL	BB	219	285	329	329	<p>BEC-0520-73-xx 7" round tub spout without diverter</p>  <table border="1"> <thead> <tr> <th>CC</th> <th>KK</th> <th>LL</th> <th>BB</th> </tr> </thead> <tbody> <tr> <td>168</td> <td>218</td> <td>252</td> <td>252</td> </tr> </tbody> </table>	CC	KK	LL	BB	168	218	252	252	<p>BEC-0520-74-xx 7" round tub spout with diverter</p>  <table border="1"> <thead> <tr> <th>CC</th> <th>KK</th> <th>LL</th> <th>BB</th> </tr> </thead> <tbody> <tr> <td>198</td> <td>257</td> <td>297</td> <td>297</td> </tr> </tbody> </table>	CC	KK	LL	BB	198	257	297	297	<p>BOD-5002-01-xx Cylindrical lateral body jet</p>  <table border="1"> <thead> <tr> <th>CC</th> <th>KK</th> <th>LL</th> <th>BB</th> </tr> </thead> <tbody> <tr> <td>199</td> <td>259</td> <td>299</td> <td>299</td> </tr> </tbody> </table>	CC	KK	LL	BB	199	259	299	299	<p>BOD-5007-01-xx Round built-in lateral body jet</p>  <table border="1"> <thead> <tr> <th>CC</th> <th>KK</th> <th>LL</th> <th>BB</th> </tr> </thead> <tbody> <tr> <td>325</td> <td>423</td> <td>488</td> <td>488</td> </tr> </tbody> </table>	CC	KK	LL	BB	325	423	488	488
CC	KK	LL	BB																																									
219	285	329	329																																									
CC	KK	LL	BB																																									
168	218	252	252																																									
CC	KK	LL	BB																																									
198	257	297	297																																									
CC	KK	LL	BB																																									
199	259	299	299																																									
CC	KK	LL	BB																																									
325	423	488	488																																									

Actual products may differ from pictures. Actual products measures may differ from the measures shown. All USD prices are subject to change without notice. Effective as of August 2023.

COMPLETE SHOWER KITS

PRO-1100-53-xx



Complete thermostatic shower kit on column

CC	KK	LL	BB	NN/YY	VV/TT	GG
1775	2308	2663	2663	2308	2840	3905

Features

- A- Max: 2 gpm - 80 psi (per accessory)
- B- 3-spray push-button hand shower
- C- 2 accessories can work together
- D- Temperature handle on the hot water inlet side, allowing the surface temperature to never exceed the shower water temperature
- E- Shower head arm adjustable up to 20" in height
- F- Easy to move metal slider with built-in hook
- G- Thermostatic cartridge: CAR-2661-00
- H- Diverter cartridge: CAR-3003-36

Ecological options	Code	Features are the same, except:
CEC	PRO-1100-53-xx-NS	A- Max: 1.75 gpm - 80 psi (per accessory) C- 1 accessory works at a time H- Diverter cartridge: CAR-3003-36-NS

PRO-2115-66-xx



Complete pressure balanced shower kit

CC	KK	LL	BB	NN/YY	VV/TT	GG
940	1222	1410	1410	1222	1504	2068

Features

- A- Max: 2 gpm - 80 psi (hand shower)
- B- 3-spray hand shower

Includes

- B66-9120-00-xx** Complete type P valve
- DGL-2175-53-xx** 3-spray sliding shower bar
- RAC-9001-16-xx** Elbow connector

Ecological options	Codes	Features are the same, except:
CEC	PRO-2115-66-xx-175	A- Max: 1.75 gpm - 80 psi (hand shower)
	TRO-2115-66-xx-175 + RVA-9020-00-B	

TRIM ONLY

TRO-2115-66-xx	CC	KK	LL	BB	NN/YY	VV/TT	GG
	630	912	1100	1100	912	1194	1758

ROUGH VALVES Please order **one** of the following rough valves to complete the trim:

RVA-9020-00-B	Type P rough - 1/2" male NPT or welded copper connections	310
RVA-9020-PO-B	Type P rough - PEX connections	310

PRO-2210-66-xx



Complete pressure balanced shower kit

CC	KK	LL	BB	NN/YY	VV/TT	GG
749	974	1124	1124	974	1198	1648

Features

- A- 2 accessories kit
- B- 6 gpm - 60 psi (bath spout)
- C- Max: 2 gpm - 80 psi (shower head)
- D- 5-spray shower head
- E- 1 accessory works at a time

Includes

- B66-9120-00-xx** Complete type P valve
- BEC-0520-74-xx** 7" round tub spout with diverter
- TET-0304-05-xx** Modern 5-spray shower head
- BRA-0612-02-xx** 6" shower arm

Ecological options	Codes	Features are the same, except:
CEC	PRO-2210-66-xx-175	C- Max: 1.75 gpm - 80 psi (shower head)
	TRO-2210-66-xx-175 + RVA-9020-00-B	

TRIM ONLY

TRO-2210-66-xx	CC	KK	LL	BB	NN/YY	VV/TT	GG
	439	664	814	814	664	888	1338

ROUGH VALVES Please order **one** of the following rough valves to complete the trim:

RVA-9020-00-B	Type P rough - 1/2" male NPT or welded copper connections	310
RVA-9020-PO-B	Type P rough - PEX connections	310

Finishes:

CC = chrome, KK = matte black, LL = satin brass, BB = white, NN = brushed nickel, YY = polished nickel, TT = venetian bronze, VV = satin copper, GG = gold

* With 6" ceiling mount shower arm

ZIP B66

PRO-2220-66-xx

Complete pressure balanced shower kit

CC	KK	LL	BB	NN/YY	VV/TT	GG
1088	1414	1632	1632	1414	1741	2394

Features

- A- 2 accessories kit
- B- 6 gpm - 60 psi (bath spout)
- C- Max: 2 gpm - 80 psi (hand shower)
- D- 3-spray hand shower
- E- 1 accessory works at a time

Includes

- B66-9120-00-xx** Complete type P valve
- BEC-0520-74-xx** 7" round tub spout with diverter
- DGL-2175-53-xx** 3-spray sliding shower bar
- RAC-9001-16-xx** Wall-mount supply elbow

Ecological options CEC

Codes

PRO-2220-66-xx-175
TRO-2220-66-xx-175 + RVA-9020-00-B

Features are the same, except:

- C- Max: 1.75 gpm - 80 psi (hand shower)

TRIM ONLY

TRO-2220-66-xx

CC	KK	LL	BB	NN/YY	VV/TT	GG
778	1104	1322	1322	1104	1431	2084

ROUGH VALVES Please order **one** of the following rough valves to complete the trim:

RVA-9020-00-B

Type P rough - 1/2" male NPT or welded copper connections

310

RVA-9020-PO-B

Type P rough - PEX connections

310

PRO-2805-66-xx

PRR-2805-66-xx*

Complete pressure balanced shower kit

CC	KK	LL	BB	NN/YY	VV/TT	GG
1598	2077	2397	2397	2077	2557	3516

Features

- A- 2 accessories kit
- B- Max: 2 gpm - 80 psi (per accessory)
- C- 3-spray hand shower
- D- 2 accessories can work together

Includes

- B66-9181-00-xx** Complete type P valve with 2-way diverter
- TET-0810-01-xx** 8" round shower head
- BRA-1612-66-xx** 16" shower arm
- DGL-2175-53-xx** 3-spray sliding shower bar
- RAC-9001-16-xx** Wall-mount supply elbow

Ecological options CEC

Codes

PRO-2805-66-xx-NS
TRO-2805-66-xx-NS + RVA-9181-00-NS-B

Features are the same, except:

- B- Max: 1.75 gpm - 80 psi (per accessory)
- D- 1 accessory works at a time

TRIM ONLY

TRO-2805-66-xx

TRR-2805-66-xx*

CC	KK	LL	BB	NN/YY	VV/TT	GG
1124	1603	1923	1923	1603	2083	3042

ROUGH VALVES Please order **one** of the following rough valves to complete the trim:

RVA-9181-00-B

2-way type P rough - 1/2" male NPT or welded copper connections

474

RVA-9181-PO-B

2-way type P rough - PEX connections

474

PRO-2815-66-xx

PRR-2815-66-xx*

Complete pressure balanced shower kit

CC

1495

Features

- A- 2 accessories kit
- B- Max: 2 gpm - 80 psi (per accessory)
- C- 3-spray hand shower
- D- 2 accessories can work together

Includes

- B66-9181-00-xx** Complete type P valve with 2-way diverter
- TET-0813-01-xx** 8" round shower head
- BRA-1612-66-xx** 16" shower arm
- DGL-2175-53-xx** 3-spray sliding shower bar
- RAC-9001-26-xx** Wall-mount supply elbow

Ecological options CEC

Codes

PRO-2815-66-xx-NS
TRO-2815-66-xx-NS + RVA-9181-00-NS-B

Features are the same, except:

- B- Max: 1.75 gpm - 80 psi (per accessory)
- D- 1 accessory works at a time

TRIM ONLY

TRO-2815-66-xx

TRR-2815-66-xx*

CC

1021

ROUGH VALVES Please order **one** of the following rough valves to complete the trim:

RVA-9181-00-B

2-way type P rough - 1/2" male NPT or welded copper connections

474

RVA-9181-PO-B

2-way type P rough - PEX connections

474



PRO-2816-66-xx PRR-2816-66-xx*



Complete pressure balanced shower kit

CC	KK
1345	1749

Features	Includes
A- 2 accessories kit B- Max: 2 gpm - 80 psi (per accessory) C- 3-spray hand shower D- 2 accessories can work together	B66-9181-00-xx Complete type P valve with 2-way diverter TET-1013-01-xx 10" round shower head BRA-1812-02-xx 18" shower arm DGL-2175-52-xx 3-spray sliding shower bar with built-in supply elbow

Ecological options	Codes	Features are the same, except:
	PRO-2816-66-xx-NS TRO-2816-66-xx-NS + RVA-9181-00-NS-B	B- Max: 1.75 gpm - 80 psi (per accessory) D- 1 accessory works at a time

TRIM ONLY

TRO-2816-66-xx TRR-2816-66-xx*	CC	KK
	871	1275

ROUGH VALVES Please order **one** of the following rough valves to complete the trim:

RVA-9181-00-B	2-way type P rough - 1/2" male NPT or welded copper connections	474
RVA-9181-PO-B	2-way type P rough - PEX connections	474

THE ESSENTIALS

PRO-2826-66-xx PRR-2826-66-xx*



Complete pressure balanced shower kit

CC	KK
1495	1944

Features	Includes
A- 2 accessories kit B- Max: 2 gpm - 80 psi (per accessory) C- 3-spray hand shower D- 2 accessories can work together	B66-9181-00-xx Complete type P valve with 2-way diverter TET-1013-01-xx 10" round shower head BRA-1812-02-xx 18" shower arm DGL-2175-53-xx 3-spray sliding shower bar RAC-9001-26-xx Wall-mount supply elbow

Ecological options	Codes	Features are the same, except:
	PRO-2826-66-xx-NS TRO-2826-66-xx-NS + RVA-9181-00-NS-B	B- Max: 1.75 gpm - 80 psi (per accessory) D- 1 accessory works at a time

TRIM ONLY

TRO-2826-66-xx TRR-2826-66-xx*	CC	KK
	1021	1470

ROUGH VALVES Please order **one** of the following rough valves to complete the trim:

RVA-9181-00-B	2-way type P rough - 1/2" male NPT or welded copper connections	474
RVA-9181-PO-B	2-way type P rough - PEX connections	474

PRO-2896-66-xx PRR-2896-66-xx*



Complete pressure balanced shower kit

CC	KK	LL	BB	NN/YY	VV/TT	GG
1525	1983	2288	2288	1983	2440	3355

Features	Includes
A- 2 accessories kit B- Max: 2 gpm - 80 psi (per accessory) C- 1-spray hand shower D- 2 accessories can work together	B66-9181-00-xx Complete pressure balanced valve with 2-way diverter TET-0810-01-xx 8" round shower head BRA-1612-66-xx 16" shower arm DSP-2604-19-xx Hand shower on wall-mounted supply elbow

Ecological options	Codes	Features are the same, except:
	PRO-2896-66-xx-NS TRO-2896-66-xx-NS + RVA-9181-00-NS-B	B- Max: 1.75 gpm - 80 psi (per accessory) D- 1 accessory works at a time

TRIM ONLY

TRO-2896-66-xx TRR-2896-66-xx*	CC	KK	LL	BB	NN/YY	VV/TT	GG
	1051	1509	1814	1814	1509	1966	2881

ROUGH VALVES Please order **one** of the following rough valves to complete the trim:

RVA-9181-00-B	2-way type P rough - 1/2" male NPT or welded copper connections	474
RVA-9181-PO-B	2-way type P rough - PEX connections	474

Finishes:
CC = chrome, KK = matte black, LL = satin brass, BB = white, NN = brushed nickel, YY = polished nickel, TT = venetian bronze, VV = satin copper, GG = gold

ZIP B66

ZIP B66

PRO-2915-66-xx PRR-2915-66-xx*



Complete pressure balanced shower kit

CC
1675

Features

- A- 3 accessories kit
- B- 5 gpm - 60 psi (bath spout)
- C- Max: 2 gpm - 80 psi (per accessory)
- D- 3-spray hand shower
- E- 2 accessories can work together

Includes

- B66-9190-00-xx** Complete type P valve with 3-way diverter
- BEC-0520-73-xx** 7" round tub spout without diverter
- TET-0813-01-xx** 8" round shower head
- BRA-1612-66-xx** 16" shower arm
- DGL-2175-53-xx** 3-spray sliding shower bar
- RAC-9001-26-xx** Wall-mount supply elbow

Ecological options CEC

Codes

PRO-2915-66-xx-NS
TRO-2915-66-xx-NS + RVA-9191-00-NS-B

Features are the same, except:

C- Max: 1.75 gpm - 80 psi (shower accessories)
E- 1 accessory works at a time

TRIM ONLY

TRO-2915-66-xx
TRR-2915-66-xx*

CC
1146

ROUGH VALVES Please order **one** of the following rough valves to complete the trim:

RVA-9191-00-B

3-way type P rough - 1/2" male NPT or welded copper connections

529

RVA-9191-PO-B

3-way type P rough - PEX connections

529

PRO-3302-66-xx PRR-3302-66-xx*



Complete thermostatic shower kit

CC	KK	LL	BB	NN/YY	VV/TT	GG
2368	3078	3552	3552	3078	3789	5210

Features

- A- 2 accessories kit
- B- Max: 2 gpm - 80 psi (per accessory)
- C- 1-spray hand shower
- D- 2 accessories can work together
- E- Hook as part of the thermostatic valve trim

Includes

- B66-9453-00-xx** Complete 3/4" thermostatic valve
- B66-9560-02-xx** Complete 2-port diverter with off
- TET-1010-01-xx** 10" round shower head
- BRA-1612-66-xx** 16" shower arm
- DSP-2604-21-xx** Hand shower on wall-mounted supply elbow

Ecological options CEC

Codes

PRO-3302-66-xx-NS
TRO-3302-66-xx-NS + RVA-3453-00-B + RVA-9562-00-NS-B

Features are the same, except:

B- Max: 1.75 gpm - 80 psi (per accessory)
D- 1 accessory works at a time

TRIM ONLY

TRO-3302-66-xx
TRR-3302-66-xx*

CC	KK	LL	BB	NN/YY	VV/TT	GG
1420	2130	2604	2604	2130	2841	4262

ROUGH VALVES Please order **all** of the following rough valves to complete the trim:

RVA-3453-00-B

Type T rough - 3/4" female NPT connections

649

RVA-9562-00-B

2-port diverter rough - 1/2" male NPT or welded copper connections

299

PRO-3405-66-xx PRR-3405-66-xx*



Complete thermostatic shower kit

CC	KK	LL	BB	NN/YY	VV/TT	GG
2295	2984	3443	3443	2984	3672	5049

Features

- A- 2 accessories kit
- B- Max: 2 gpm - 80 psi (per accessory)
- C- 3-spray hand shower
- D- 2 accessories can work together

Includes

- B66-9404-00-xx** Complete 3/4" thermostatic valve
- B66-9560-02-xx** Complete 2-port diverter with stop
- TET-1010-01-xx** 10" round shower head
- BRA-1612-66-xx** 16" shower arm
- DGL-2175-53-xx** 3-spray sliding shower bar
- RAC-9001-16-xx** Wall-mount supply elbow

Ecological options CEC

Codes

PRO-3405-66-xx-NS
TRO-3405-66-xx-NS + RVA-3404-00-B + RVA-9562-00-NS-B

Features are the same, except:

B- Max: 1.75 gpm - 80 psi (per accessory)
D- 1 accessory works at a time

TRIM ONLY

TRO-3405-66-xx
TRR-3405-66-xx*

CC	KK	LL	BB	NN/YY	VV/TT	GG
1314	2003	2462	2462	2003	2691	4068

ROUGH VALVES Please order **all** of the following rough valves to complete the trim:

RVA-3404-00-B

Type T rough - 3/4" female NPT connections

682

RVA-9562-00-B

2-port diverter rough - 1/2" male NPT or welded copper connections

299

PRO-4201-66-xx PRR-4201-66-xx*



Complete thermostatic pressure balanced shower kit

CC	KK	LL	BB	NN/YY	VV/TT	GG
1890	2457	2835	2835	2457	3024	4158

Features

- A- 2 accessories kit
- B- Max: 2 gpm - 80 psi (per accessory)
- C- 3-spray hand shower
- D- 2 accessories can work together

Includes

- B66-9521-00-xx** Complete TP shower control valve with 2-way diverter
- TET-0810-01-xx** 8" round shower head
- BRA-1612-66-xx** 16" shower arm
- DGL-2070-53-xx** 3-spray sliding shower bar
- RAC-9001-16-xx** Wall-mount supply elbow

Ecological options CEC

Codes

PRO-4201-66-xx-NS
TRO-4201-66-xx-NS + RVA-9521-00-NS-B

Features are the same, except:

B- Max: 1.75 gpm - 80 psi (per accessory)
D- 1 accessory works at a time

TRIM ONLY

TRO-4201-66-xx TRR-4201-66-xx*

CC	KK	LL	BB	NN/YY	VV/TT	GG
1205	1772	2150	2150	1772	2339	3473

ROUGH VALVES Please order **one** of the following rough valves to complete the trim:

RVA-9521-00-B	2-way TP rough - 1/2" male NPT or welded copper connections	685
RVA-9521-PO-B	2-way TP rough - PEX connections	685

THE ESSENTIALS

PRO-4206-66-xx PRR-4206-66-xx*



Complete thermostatic pressure balanced shower kit

CC	KK	LL	BB	NN/YY	VV/TT	GG
1790	2327	2685	2685	2327	2864	3938

Features

- A- 2 accessories kit
- B- Max: 2 gpm - 80 psi (per accessory)
- C- 3-spray hand shower
- D- 2 accessories can work together

Includes

- B66-9521-00-xx** Complete TP shower control valve with 2-way diverter
- TET-0810-01-xx** 8" round shower head
- BRA-1612-66-xx** 16" shower arm
- DGL-2175-53-xx** 3-spray sliding shower bar
- RAC-9001-16-xx** Wall-mount supply elbow

Ecological options CEC

Codes

PRO-4206-66-xx-NS
TRO-4206-66-xx-NS + RVA-9521-00-NS-B

Features are the same, except:

B- Max: 1.75 gpm - 80 psi (per accessory)
D- 1 accessory works at a time

TRIM ONLY

TRO-4206-66-xx TRR-4206-66-xx*

CC	KK	LL	BB	NN/YY	VV/TT	GG
1105	1642	2000	2000	1642	2179	3253

ROUGH VALVES Please order **one** of the following rough valves to complete the trim:

RVA-9521-00-B	2-way TP rough - 1/2" male NPT or welded copper connections	685
RVA-9521-PO-B	2-way TP rough - PEX connections	685

THE ESSENTIALS

PRO-4216-66-xx PRR-4216-66-xx*



Complete thermostatic pressure balanced shower kit

CC	KK
1600	2080

Features

- A- 2 accessories kit
- B- Max: 2 gpm - 80 psi (per accessory)
- C- 3-spray hand shower
- D- 2 accessories can work together

Includes

- B66-9521-00-xx** Complete TP shower control valve with 2-way diverter
- TET-1013-01-xx** 10" round shower head
- BRA-1612-66-xx** 16" shower arm
- DGL-2175-53-xx** 3-spray sliding shower bar
- RAC-9001-26-xx** Wall-mount supply elbow

Ecological options CEC

Codes

PRO-4216-66-xx-NS
TRO-4216-66-xx-NS + RVA-9521-00-NS-B

Features are the same, except:

B- Max: 1.75 gpm - 80 psi (per accessory)
D- 1 accessory works at a time

TRIM ONLY

TRO-4216-66-xx TRR-4216-66-xx*

CC	KK
915	1395

ROUGH VALVES Please order **one** of the following rough valves to complete the trim:

RVA-9521-00-B	2-way TP rough - 1/2" male NPT or welded copper connections	685
RVA-9521-PO-B	2-way TP rough - PEX connections	685

Finishes:

CC = chrome, KK = matte black, LL = satin brass, BB = white, NN = brushed nickel, YY = polished nickel, TT = venetian bronze, VV = satin copper, GG = gold

* With 6" ceiling mount shower arm

ZIP B66

PRO-4297-66-xx PRR-4297-66-xx*



Complete thermostatic pressure balanced shower kit

CC	KK	LL	BB	NN/YY	VV/TT	GG
1635	2126	2453	2453	2126	2616	3597

Features

- A- 2 accessories kit
- B- Max: 2 gpm - 80 psi (per accessory)
- C- 3-spray hand shower
- D- 2 accessories can work together

Includes

- B66-9521-00-xx** Complete TP valve with 2-way diverter
- TET-0810-01-xx** 8" round shower head
- BRA-1612-66-xx** 16" shower arm
- DSP-2566-19-xx** Hand shower on wall-mounted supply elbow

Ecological options CEC

Codes

PRO-4297-66-xx-NS
TRO-4297-66-xx-NS + RVA-9521-00-NS-B

Features are the same, except:

B- Max: 1.75 gpm - 80 psi (per accessory)
D- 1 accessory works at a time

TRIM ONLY

TRO-4297-66-xx TRR-4297-66-xx*

CC	KK	LL	BB	NN/YY	VV/TT	GG
950	1441	1768	1768	1441	1931	2912

ROUGH VALVES Please order **one** of the following rough valves to complete the trim:

RVA-9521-00-B

2-way TP rough - 1/2" male NPT or welded copper connections

685

RVA-9521-PO-B

2-way TP rough - PEX connections

685

PRO-4302-66-xx PRR-4302-66-xx*



Complete thermostatic pressure balanced shower kit

CC	KK	LL	BB	NN/YY	VV/TT	GG
2159	2807	3239	3239	2807	3454	4750

Features

- A- 3 accessories kit
- B- 7.9 gpm - 60 psi (bath spout)
- C- Max: 2 gpm - 80 psi (shower accessories)
- D- 3-spray hand shower
- E- 2 accessories can work together

Includes

- B66-9531-00-xx** Complete TP shower control valve with 3-way diverter
- BEC-0520-37-xx** Modern round tub spout without diverter
- TET-0810-01-xx** 8" round shower head
- BRA-1612-66-xx** 16" shower arm
- DGL-2070-53-xx** 3-spray sliding shower bar
- RAC-9001-16-xx** Wall-mount supply elbow

Ecological options CEC

Codes

PRO-4302-66-xx-NS
TRO-4302-66-xx-NS + RVA-9531-00-NS-B

Features are the same, except:

C- Max: 1.75 gpm - 80 psi (shower accessories)
E- 1 accessory works at a time

TRIM ONLY

TRO-4302-66-xx TRR-4302-66-xx*

CC	KK	LL	BB	NN/YY	VV/TT	GG
1364	2012	2444	2444	2012	2659	3955

ROUGH VALVES Please order **one** of the following rough valves to complete the trim:

RVA-9531-00-B

3-way TP rough - 1/2" male NPT or welded copper connections

795

RVA-9531-PO-B

3-way TP rough - PEX connections

795

THE ESSENTIALS

PRO-4306-66-xx PRR-4306-66-xx*



Complete thermostatic pressure balanced shower kit

CC	KK	LL	BB	NN/YY	VV/TT	GG
2060	2678	3090	3090	2678	3296	4532

Features

- A- 3 accessories kit
- B- 7.9 gpm - 60 psi (bath spout)
- C- Max: 2 gpm - 80 psi (shower accessories)
- D- 3-spray hand shower
- E- 2 accessories can work together

Includes

- B66-9531-00-xx** Complete TP shower control valve with 3-way diverter
- BEC-0520-37-xx** Modern round tub spout without diverter
- TET-0810-01-xx** 8" round shower head
- BRA-1612-66-xx** 16" shower arm
- DGL-2175-53-xx** 3-spray sliding shower bar
- RAC-9001-16-xx** Wall-mount supply elbow

Ecological options CEC

Codes

PRO-4306-66-xx-NS
TRO-4306-66-xx-NS + RVA-9531-00-NS-B

Features are the same, except:

C- Max: 1.75 gpm - 80 psi (shower accessories)
E- 1 accessory works at a time

TRIM ONLY

TRO-4306-66-xx TRR-4306-66-xx*

CC	KK	LL	BB	NN/YY	VV/TT	GG
1265	1883	2295	2295	1883	2501	3737

ROUGH VALVES Please order **one** of the following rough valves to complete the trim:

RVA-9531-00-B

3-way TP rough - 1/2" male NPT or welded copper connections

795

RVA-9531-PO-B

3-way TP rough - PEX connections

795

PRO-4316-66-xx PRR-4316-66-xx*

Complete thermostatic pressure balanced shower kit

CC	KK
1895	2464



Features

- A- 3 accessories kit
- B- 7.9 gpm - 60 psi (bath spout)
- C- Max: 2 gpm - 80 psi (shower accessories)
- D- 3-spray hand shower
- E- 2 accessories can work together

Includes

- B66-9531-00-xx** Complete TP shower control valve with 3-way diverter
- BEC-0520-37-xx** Modern round tub spout without diverter
- TET-1013-01-xx** 10" round shower head
- BRA-1612-66-xx** 16" shower arm
- DGL-2175-53-xx** 3-spray sliding shower bar
- RAC-9001-26-xx** Wall-mount supply elbow

Ecological options CEC

Codes

PRO-4316-66-xx-NS
TRO-4316-66-xx-NS + RVA-9531-00-NS-B

Features are the same, except:

C- Max: 1.75 gpm - 80 psi (shower accessories)
E- 1 accessory works at a time

TRIM ONLY

TRO-4316-66-xx TRR-4316-66-xx*

CC	KK
1100	1669

ROUGH VALVES Please order **one** of the following rough valves to complete the trim:

RVA-9531-00-B

3-way TP rough - 1/2" male NPT or welded copper connections

795

RVA-9531-P0-B

3-way TP rough - PEX connections

795

PRO-4394-66-xx PRR-4394-66-xx*

Complete thermostatic pressure balanced shower kit

CC	KK	LL	BB	NN/YY	VV/TT	GG
2568	3338	3852	3852	3338	4109	5650



Features

- A- 3 accessories kit
- B- Max: 2 gpm - 80 psi (per accessory)
- C- 4.5 gpm for 3 body jets
- D- 3-spray hand shower
- E- 2 accessories can work together

Includes

- B66-9531-00-xx** Complete TP shower control valve with 3-way diverter
- TET-1010-01-xx** 10" round shower head
- BRA-1612-66-xx** 16" shower arm
- DGL-2175-53-xx** 3-spray sliding shower bar
- RAC-9001-16-xx** Wall-mount supply elbow
- BOD-5002-01-xx** Cylindrical lateral body jet (3)

TRIM ONLY

TRO-4394-66-xx TRR-4394-66-xx*

CC	KK	LL	BB	NN/YY	VV/TT	GG
1773	2543	3057	3057	2543	3314	4855

ROUGH VALVES Please order **one** of the following rough valves to complete the trim:

RVA-9531-00-B

3-way TP rough - 1/2" male NPT or welded copper connections

795

RVA-9531-P0-B

3-way TP rough - PEX connections

795

Finishes:

CC = chrome, KK = matte black, LL = satin brass, BB = white, NN = brushed nickel, YY = polished nickel, TT = venetian bronze, VV = satin copper, GG = gold

* With 6" ceiling mount shower arm

ZIP B66

SELECTION OF BATHROOM ACCESSORIES

For more bathroom accessories, please refer to the bathroom accessories section (see p. 293-306).

A66-1029-01-xx

ZIP
Wall-mounted toilet paper holder



CC	KK	LL	BB	NN/YY	VV/TT	GG
197	256	296	296	256	315	433

A66-1069-01-xx

ZIP
Bathrobe holder



CC	KK	LL	BB	NN/YY	VV/TT	GG
99	129	149	149	129	158	218

A66-1079-00-xx

ZIP
Bathrobe holder



CC	KK	LL	BB	NN/YY	VV/TT	GG
79	103	119	119	103	126	174

A66-6018-00-xx

ZIP
18" single towel bar



CC	KK	LL	BB	NN/YY	VV/TT	GG
299	389	449	449	389	478	658

A66-6024-00-xx

ZIP
24" single towel bar



CC	KK	LL	BB	NN/YY	VV/TT	GG
323	420	485	485	420	517	711

A66-6030-00-xx

ZIP
30" single towel bar



CC	KK	LL	BB	NN/YY	VV/TT	GG
381	495	571	571	495	609	838

A66-6315-00-xx

ZIP
Triple towel bar

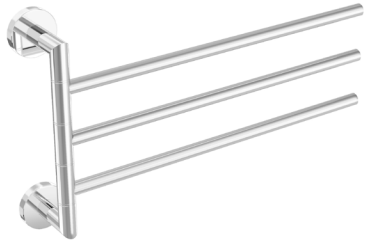

CC	KK	LL	BB	NN/YY	VV/TT	GG
399	519	599	599	519	638	878

A85-2009-40-xx

Towel holder on stand



CC
523

Actual products may differ from pictures. Actual products measures may differ from the measures shown. All USD prices are subject to change without notice. Effective as of August 2023.

EVA B71 B72

Compatible with the Touchless Sensor
Order ELE-2001-01-xx (p. 43)



BARIL

EVA B71 B72

B7X-8001-01L-xx

B71-8001-01L-xx

EVA



CC	KK	LL	BB	NN/YY	VV/TT	GG
1035	1345	1552	1552	1345	1656	2276

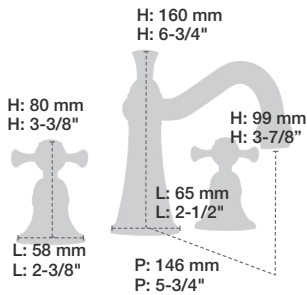

B72-8001-01L-xx

TRADITION



CC	KK	LL	BB	NN/YY	VV/TT	GG
1035	1345	1552	1552	1345	1656	2276

8" c/c lavatory faucet, drain included

- A- 1.5 gpm - 60 psi
- B- Drain included
- C- Adjustable aerator
- D- CAR-1020-01 (Cold), CAR-1020-02 (Hot)

Ecological options

Codes	Reduced flow rates	CEC
B7X-8001-01L-xx-120	1.2 gpm (4.5 l/min) - 60 psi	
B7X-8001-01L-xx-100	1.0 gpm (3.7 l/min) - 60 psi	
B7X-8001-01L-xx-050	0.5 gpm (1.9 l/min) - 60 psi	

B7X-8041-00L-xx

B71-8041-00L-xx

EVA



CC	KK	LL	BB	NN/YY	VV/TT	GG
1011	1314	1517	1517	1314	1618	2225

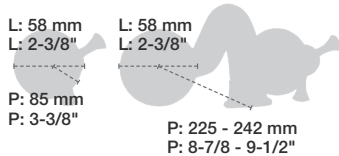

B72-8041-00L-xx

TRADITION



CC	KK	LL	BB	NN/YY	VV/TT	GG
1011	1314	1517	1517	1314	1618	2225

Wall-mounted lavatory faucet, drain not included

- A- 1.5 gpm - 60 psi
- B- Slip-on spout for easy adjustment
- C- Single piece rough for easy installation
- D- Order your lavatory drain (pages 309-310)
- E- Adjustable aerator
- F- CAR-1011-80 (Cold), CAR-1011-81 (Hot)

Ecological options

Codes	Reduced flow rates	CEC
B7X-8041-00L-xx-120	1.2 gpm (4.5 l/min) - 60 psi	
B7X-8041-00L-xx-100	1.0 gpm (3.7 l/min) - 60 psi	
B7X-8041-00L-xx-050	0.5 gpm (1.9 l/min) - 60 psi	

Actual products may differ from pictures. Actual products measures may differ from the measures shown. All USD prices are subject to change without notice. Effective as of August 2023.

EVA B71 B72

B7X-1201-01-xx

B71-1201-01-xx

EVA



CC	KK	LL	BB	NN/YY	VV/TT	GG
1195	1554	1793	1793	1554	1912	2629

B72-1201-01-xx

TRADITION



CC	KK	LL	BB	NN/YY	VV/TT	GG
1195	1554	1793	1793	1554	1912	2629

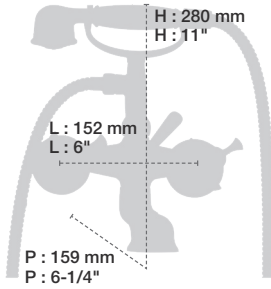

Wall-mounted tub faucet with hand shower

Bath spout:

- A- 6 gpm - 60 psi
- B- Vertical closed position of the handles
- C- Ceramic diverter cartridge CAR-1219-02
- D- CAR-1020-01 (Cold), CAR-1020-02 (Hot)

Hand shower:

- E- Max: 2 gpm - 80 psi
- F- DOU-1219-01-xx metal hand shower
- G- 59" (150 cm) double interlock flexible hose, rotating nut with 2 non-return valves

Ecological options

Codes	Reduced flow rates
B7X-1201-01-xx-150	1.5 gpm (5.7 l/min) - 80 psi
B7X-1201-01-xx-175	1.75 gpm (6.6 l/min) - 80 psi

B7X-9404-00-xx

ROUGH & TRIM PACKAGE

B71-9404-00-xx

EVA



CC	KK	LL	BB	NN/YY	VV/TT	GG
1243	1411	1524	1524	1411	1580	1916

B72-9404-00-xx

TRADITION



CC	KK	LL	BB	NN/YY	VV/TT	GG
1243	1411	1524	1524	1411	1580	1916

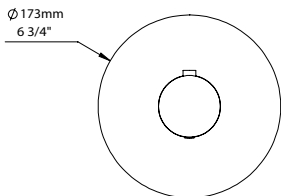

Complete 3/4" thermostatic valve

- A- 16 gpm - 60 psi
- B- Separate volume control or diverter valve required
- C- Can easily supply 3 accessories

- D- CAR-3404-00
- E- Rough valve RVA-3404-00-B included
- F- Reversible check / non-return valves in case of water supply inversion

TRIM ONLY

T71-9404-00-xx	EVA	CC	KK	LL	BB	NN/YY	VV/TT	GG
		561	729	842	842	729	898	1234
T72-9404-00-xx	TRADITION	CC	KK	LL	BB	NN/YY	VV/TT	GG
		561	729	842	842	729	898	1234

ROUGH VALVE Please order the following rough valve to complete the trim:

RVA-3404-00-B	Type T rough - 3/4" female NPT connections	682
---------------	--------------------------------------------	-----

Finishes:

CC = chrome, KK = matte black, LL = satin brass, BB = white, NN = brushed nickel, YY = polished nickel, TT = venetian bronze, VV = satin copper, GG = gold 217

EVA B71 B72

EVA B71 B72

B7X-9560-02-xx

ROUGH & TRIM PACKAGE

B71-9560-02-xx

EVA



CC	KK	LL	BB	NN/YY	VV/TT	GG
586	672	730	730	672	758	930

B72-9560-02-xx

TRADITION



CC	KK	LL	BB	NN/YY	VV/TT	GG
586	672	730	730	672	758	930

SHARED PORT

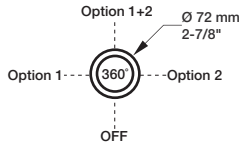

NON-SHARED PORT

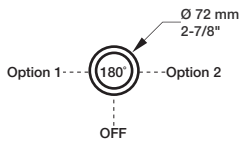

Complete 2-port diverter with off (shared port)

- A- 1 outlet: 10.5 gpm - 60 psi
- A- 2 outlets: 4 gpm - 60 psi
- B- Can replace 2 volume control valves

- C- Up to 2 accessories can be used at the same time
- D- CAR-9525-02
- E- Rough RVA-9562-00-B included
- F- Extra long cartridge for maximum adjustment

Ecological options CEC

Codes	Features
B7X-9560-02-xx-NS	Non-shared port
T7X-9560-02-xx + RVA-9562-00-NS-B	1 accessory works at a time CAR-9525-02-NS (diverter)

TRIM ONLY

T71-9560-02-xx	EVA	CC	KK	LL	BB	NN/YY	VV/TT	GG
		287	373	431	431	373	459	631

T72-9560-02-xx	TRADITION	CC	KK	LL	BB	NN/YY	VV/TT	GG
		287	373	431	431	373	459	631

ROUGH VALVE Please order the following rough valve to complete the trim:

RVA-9562-00-B	2-port diverter rough - 1/2" male NPT or welded copper connections	299
---------------	--------------------------------------------------------------------	-----

B7X-9560-03-xx

ROUGH & TRIM PACKAGE

B71-9560-03-xx

EVA



CC	KK	LL	BB	NN/YY	VV/TT	GG
668	754	812	812	754	840	1012

B72-9560-03-xx

TRADITION



CC	KK	LL	BB	NN/YY	VV/TT	GG
668	754	812	812	754	840	1012

SHARED PORT

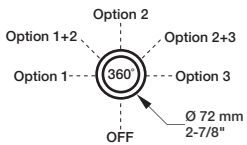

NON-SHARED PORT

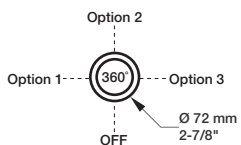

Complete 3-port diverter with off (shared port)

- A- 1 outlet: 9.7 gpm - 60 psi
- A- 2 outlets: 5.2 gpm - 60 psi
- B- Can replace 2 or 3 volume control valves

- C- Up to 2 accessories can be used at the same time
- D- CAR-9530-03
- E- Rough RVA-9563-00-B included
- F- Extra long cartridge for maximum adjustment

Ecological options CEC

Codes	Features
B7X-9560-03-xx-NS	Non-shared port
T7X-9560-03-xx + RVA-9563-00-NS-B	1 accessory works at a time CAR-9530-03-NS (diverter)

TRIM ONLY

T71-9560-03-xx	EVA	CC	KK	LL	BB	NN/YY	VV/TT	GG
		287	373	431	431	373	459	631

T72-9560-03-xx	TRADITION	CC	KK	LL	BB	NN/YY	VV/TT	GG
		287	373	431	431	373	459	631

ROUGH VALVE Please order the following rough valve to complete the trim:

RVA-9563-00-B	3-port diverter rough - inlet: 3/4" F NPT - outlets: 1/2" F NPT	381
---------------	-----------------------------------------------------------------	-----

EVA B71 B72

B7X-9601-00-xx

ROUGH & TRIM PACKAGE

B71-9601-00-xx

EVA



CC	KK	LL	BB	NN/YY	VV/TT	GG
461	547	605	605	547	633	805

B72-9601-00-xx

TRADITION



CC	KK	LL	BB	NN/YY	VV/TT	GG
461	547	605	605	547	633	805

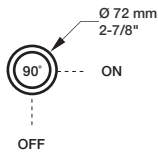

Complete 1/2" volume control valve

- A- 7.9 gpm - 60 psi
- B- Volume control valve
- C- CAR-1011-81
- D- Rough valve RVA-2020-01-B included
- E- Extra long cartridge for maximum adjustment

TRIM ONLY

T71-9601-00-xx	EVA	CC	KK	LL	BB	NN/YY	VV/TT	GG
		287	373	431	431	373	459	631

T72-9601-00-xx	TRADITION	CC	KK	LL	BB	NN/YY	VV/TT	GG
		287	373	431	431	373	459	631

ROUGH VALVE Please order the following rough valve to complete the trim:

RVA-2020-01-B	Volume control valve rough - 1/2" female NPT connections	174
---------------	----------------------------------------------------------	-----



B7X-9641-00-xx

ROUGH & TRIM PACKAGE

B71-9641-00-xx

EVA



CC	KK	LL	BB	NN/YY	VV/TT	GG
522	608	666	666	608	694	866

B72-9641-00-xx

TRADITION



CC	KK	LL	BB	NN/YY	VV/TT	GG
522	608	666	666	608	694	866

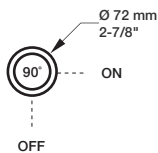

Complete 3/4" volume control valve

- A- 11.1 gpm - 60 psi
- B- Volume control valve
- C- Offers higher flow
- D- CAR-2719-34
- E- Rough valve RVA-2719-34-B included
- F- Extra long cartridge for maximum adjustment

TRIM ONLY

T71-9641-00-xx	EVA	CC	KK	LL	BB	NN/YY	VV/TT	GG
		287	373	431	431	373	459	631

T72-9641-00-xx	TRADITION	CC	KK	LL	BB	NN/YY	VV/TT	GG
		287	373	431	431	373	459	631

ROUGH VALVE Please order the following rough valve to complete the trim:

RVA-2719-34-B	Volume control valve rough - 3/4" female NPT connections	235
---------------	----------------------------------------------------------	-----



Finishes:

CC = chrome, KK = matte black, LL = satin brass, BB = white, NN = brushed nickel, YY = polished nickel, TT = venetian bronze, VV = satin copper, GG = gold 219

EVA B71 B72

SELECTION OF SHOWER COMPONENTS

For more shower components and for ecological options, please refer to the shower components section (see p. 347-382).

TET-0812-03-xx
8" sunflower shower head



CC	KK	LL	BB
168	218	252	252

CC	KK	LL	BB
495	644	743	743

BRA-1812-02-xx
18" shower arm



CC	KK	LL	BB
168	218	252	252

RAC-0618-02-xx
6" ceiling mount shower arm



CC	KK	LL	BB
68	88	102	102

DGL-2160-04-xx
4-spray sliding shower bar



CC	KK	LL	BB
798	1037	1197	1197

BOD-5001-00-xx
Lateral body jet



CC	KK	LL	BB
139	181	209	209

BOD-5007-01-xx
Round built-in lateral body jet



CC	KK	LL	BB
325	423	488	488

RAC-9001-13-xx
1/2"F wall-mount supply elbow



CC	KK	LL	BB
88	114	132	132

RAC-9001-16-xx
1/2"F wall-mount supply elbow



CC	KK	LL	BB
124	161	186	186

Actual products may differ from pictures. Actual products measures may differ from the measures shown. All USD prices are subject to change without notice. Effective as of August 2023.

COMPLETE SHOWER KITS

PRO-1100-71-xx



Complete thermostatic shower kit on column

CC	KK	LL	BB	NN/YY	VV/TT	GG
2495	3244	3743	3743	3244	3992	5489

Features

- A- Max: 2 gpm - 80 psi (per accessory)
- B- 3-spray hand shower
- C- 2 accessories can work together
- D- Temperature handle on the hot water inlet side, allowing the surface temperature to never exceed the shower water temperature
- E- Shower head arm adjustable up to 20" in height
- F- Easy to move metal slider with built-in hook
- G- Thermostatic cartridge: CAR-2660-00
- H- Diverter cartridge: CAR-3003-36

Ecological options	CEC	Code	Features are the same, except:
		PRO-1100-71-xx-NS	A- Max: 1.75 gpm - 80 psi (per accessory) C- 1 accessory works at a time G- Diverter cartridge: CAR-3003-36-NS

PRO-3420-71-xx PRR-3420-71-xx*



Complete thermostatic shower kit

CC	KK	LL	BB	NN/YY	VV/TT	GG
2750	3575	4125	4125	3575	4400	6050

Features

- A- 2 accessories kit
- B- Max: 2 gpm - 80 psi (per accessory)
- C- 4-spray hand shower
- D- 2 accessories can work together

Includes

- B71-9404-00-xx** Complete 3/4" thermostatic valve
- B71-9560-02-xx** Complete 2-port diverter with stop
- TET-0812-03-xx** 8" sunflower shower head
- BRA-1812-02-xx** 18" shower arm
- DGL-2160-04-xx** 4-spray sliding shower bar
- RAC-9001-13-xx** Elbow connector

Ecological options	CEC	Codes	Features are the same, except:
		PRO-3420-71-xx-NS	B- Max: 1.75 gpm - 80 psi (per accessory) D- 1 accessory works at a time
		TRO-3420-71-xx-NS + RVA-3404-00-B + RVA-9562-00-NS-B	

TRIM ONLY

TRO-3420-71-xx TRR-3420-71-xx*	CC	KK	LL	BB	NN/YY	VV/TT	GG
	1769	2594	3144	3144	2594	3419	5069

ROUGH VALVES Please order all of the following rough valves to complete the trim:

RVA-3404-00-B	Type T rough - 3/4" female NPT connections	682
RVA-9562-00-B	2-port diverter rough - 1/2" male NPT or welded copper connections	299

* With 6" ceiling mount shower arm

Finishes:

CC = chrome, KK = matte black, LL = satin brass, BB = white, NN = brushed nickel, YY = polished nickel, TT = venetian bronze, VV = satin copper, GG = gold

EVA B71 B72

PRO-3420-72-xx PRR-3420-72-xx*



Complete thermostatic shower kit

CC	KK	LL	BB	NN/YY	VV/TT	GG
2750	3575	4125	4125	3575	4400	6050

Features

- A- 2 accessories kit
- B- Max: 2 gpm - 80 psi (per accessory)
- C- 4-spray hand shower
- D- 2 accessories can work together

Includes

- B72-9404-00-xx** Complete 3/4" thermostatic valve
- B72-9560-02-xx** Complete 2-port diverter with stop
- TET-0812-03-xx** 8" sunflower shower head
- BRA-1812-02-xx** 18" shower arm
- DGL-2160-04-xx** 4-spray sliding shower bar
- RAC-9001-13-xx** Elbow connector

Ecological options **CEC**

Codes

PRO-3420-72-xx-NS
TRO-3420-72-xx-NS + RVA-3404-00-B +
RVA-9562-00-NS-B

Features are the same, except:

B- Max: 1.75 gpm - 80 psi (per accessory)
D- 1 accessory works at a time

TRIM ONLY

TRO-3420-72-xx TRR-3420-72-xx*

CC	KK	LL	BB	NN/YY	VV/TT	GG
1769	2594	3144	3144	2594	3419	5069

ROUGH VALVES Please order **all** of the following rough valves to complete the trim:

RVA-3404-00-B

Type T rough - 3/4" female NPT connections

682

RVA-9562-00-B

2-port diverter rough - 1/2" male NPT or welded copper connections

299

VICTOIRE B74

Compatible with the Touchless Sensor
Order ELE-2001-01-xx (p. 43)



BARIL

VICTOIRE B74

MON-2600-00L-xx

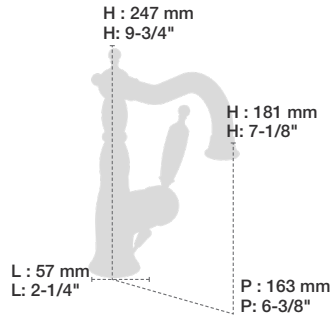

CB	KB	LB	BB	NB/YB	VB/TB	GB
1018	1323	1527	1527	1323	1629	2240

Antique style single-hole lavatory faucet, drain included

- A- 1.5 gpm - 60 psi
- B- Drain included
- C- Adjustable aerator
- D- Swivel spout
- E- CAR-1000-17

Ecological options

Codes	Reduced flow rates	
MON-2600-00L-xx-120	1.2 gpm (4.5 l/min) - 60 psi	CEC
MON-2600-00L-xx-100	1.0 gpm (3.7 l/min) - 60 psi	
MON-2600-00L-xx-050	0.5 gpm (1.9 l/min) - 60 psi	

B74-1201-01-xx

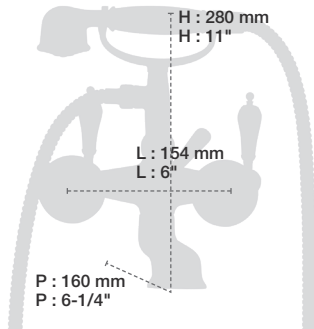

CB	KB	LB	BB	NB/YB	VB/TB	GB
1195	1554	1793	1793	1554	1912	2629

Wall-mounted tub faucet with hand shower

Bath spout:

- A- 6 gpm - 60 psi
- B- Vertical closed position of the handles
- C- Ceramic diverter cartridge CAR-1219-02
- D- CAR-1020-01 (Cold), CAR-1020-02 (Hot)

Hand shower:

- E- Max: 2 gpm - 80 psi
- F- DOU-1219-01-xx metal hand shower
- G- 59" (150 cm) double interlock flexible hose, rotating nut with 2 non-return valves

Ecological options

Codes	Reduced flow rates	
B74-1201-01-xx-150	1.5 gpm (5.7 l/min) - 80 psi	
B74-1201-01-xx-175	1.75 gpm (6.6 l/min) - 80 psi	CEC

B74-9404-00-xx

ROUGH & TRIM PACKAGE

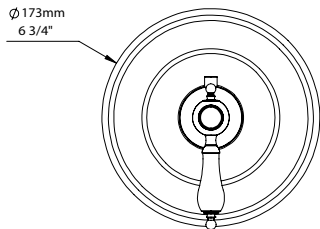

TRIM ONLY

T74-9404-00-xx

ROUGH VALVE Please order the following rough valve to complete the trim:

RVA-3404-00-B

Type T rough - 3/4" female NPT connections

CB	KB	LB	BB	NB/YB	VB/TB	GB
1243	1411	1524	1524	1411	1580	1916

Complete 3/4" thermostatic valve

- A- 16 gpm - 60 psi
- B- Separate volume control or diverter valve required
- C- Can easily supply 3 accessories
- D- CAR-3404-00
- E- Rough valve RVA-3404-00-B included
- F- Reversible check / non-return valves in case of water supply inversion

CB	KB	LB	BB	NB/YB	VB/TB	GB
561	729	842	842	729	898	1234

682



Actual products may differ from pictures. Actual products measures may differ from the measures shown. All USD prices are subject to change without notice. Effective as of August 2023.

VICTOIRE B74

B74-9560-02-xx

ROUGH & TRIM PACKAGE

CB	KB	LB	BB	NB/YB	VB/TB	GB
586	672	730	730	672	758	930

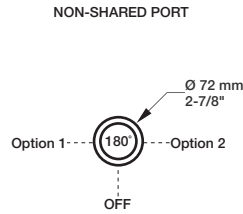
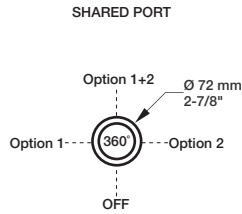

Complete 2-port diverter with stop (shared port)

- A- 1 outlet: 10.5 gpm - 60 psi, 2 outlets: 4 gpm - 60 psi
- B- Can replace 2 volume control valves
- C- Up to 2 accessories can be used at the same time
- D- CAR-9525-02
- E- Rough RVA-9562-00-B included
- F- Extra long cartridge for maximum adjustment

Ecological options CEC

Codes	Features
B74-9560-02-xx-NS	Non-shared port
T74-9560-02-xx + RVA-9562-00-NS-B	1 accessory works at a time CAR-9525-02-NS (diverter)

TRIM ONLY

T74-9560-02-xx

CB	KB	LB	BB	NB/YB	VB/TB	GB
287	373	431	431	373	459	631

ROUGH VALVE Please order the following rough valve to complete the trim:

RVA-9562-00-B

2-port diverter rough - 1/2" male NPT or welded copper connections

299



B74-9560-03-xx

ROUGH & TRIM PACKAGE

CB	KB	LB	BB	NB/YB	VB/TB	GB
668	754	812	812	754	840	1012

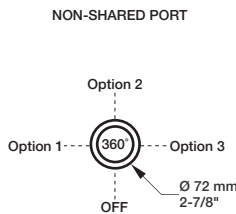
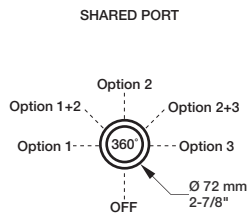

Complete 3-port diverter with stop (shared port)

- A- 1 outlet: 9.7 gpm - 60 psi, 2 outlets: 5.2 gpm - 60 psi
- B- Can replace 3 volume control valves
- C- Up to 2 accessories can be used at the same time
- D- CAR-9530-03
- E- Rough RVA-9563-00-B included
- F- Extra long cartridge for maximum adjustment

Ecological options CEC

Codes	Features
B74-9560-03-xx-NS	Non-shared port
T74-9560-03-xx + RVA-9563-00-NS-B	1 accessory works at a time CAR-9530-03-NS (diverter)

TRIM ONLY

T74-9560-03-xx

CB	KB	LB	BB	NB/YB	VB/TB	GB
287	373	431	431	373	459	631

ROUGH VALVE Please order the following rough valve to complete the trim:

RVA-9563-00-B

3-port diverter rough - inlet: 3/4" F NPT - outlets: 1/2" F NPT

381



B74-9601-00-xx

ROUGH & TRIM PACKAGE

CB	KB	LB	BB	NB/YB	VB/TB	GB
461	547	605	605	547	633	805

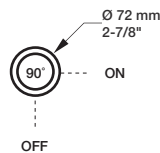

Complete 1/2" volume control valve

- A- 7.9 gpm - 60 psi
- B- Volume control valve
- C- CAR-1011-81
- D- Rough valve RVA-2020-01-B included
- E- Extra long cartridge for maximum adjustment

TRIM ONLY

T74-9601-00-xx

CB	KB	LB	BB	NB/YB	VB/TB	GB
287	373	431	431	373	459	631

ROUGH VALVE Please order the following rough valve to complete the trim:

RVA-2020-01-B

Volume control valve rough - 1/2" female NPT connections

174



Finishes :

CB = chrome white, KB = matte black white, LB = satin brass white, NB = brushed nickel white, YB = polished nickel white, TB = venetian bronze white, VB = satin copper, GB = gold white

VICTOIRE B74

B74-9641-00-XX

ROUGH & TRIM PACKAGE

CB	KB	LB	BB	NB/YB	VB/TB	GB
522	608	666	666	608	694	866

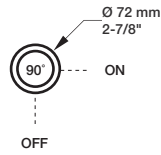

Complete 3/4" volume control valve

- A- 11.1 gpm - 60 psi
- B- Volume control valve
- C- Offers higher flow
- D- CAR-2719-34
- E- Rough valve RVA-2719-34-B included
- F- Extra long cartridge for maximum adjustment

TRIM ONLY

T74-9641-00-XX

CB	KB	LB	BB	NB/YB	VB/TB	GB
287	373	431	431	373	459	631



ROUGH VALVE Please order the following rough valve to complete the trim:

RVA-2719-34-B

Volume control valve rough - 3/4" female NPT connections

235

VICTOIRE B74

SELECTION OF SHOWER COMPONENTS

For more shower components and for ecological options, please refer to the shower components section (see p. 347-382).

TET-0812-03-xx
8" sunflower shower head



CC	KK	LL	BB
168	218	252	252

CC	KK	LL	BB
495	644	743	743

BRA-1812-02-xx
18" shower arm



CC	KK	LL	BB
168	218	252	252

RAC-0618-02-xx
6" ceiling mount shower arm



CC	KK	LL	BB
68	88	102	102

DGL-2160-04-xx
4-spray sliding shower bar



CC	KK	LL	BB
798	1037	1197	1197

BOD-5001-00-xx
Lateral body jet



CC	KK	LL	BB
139	181	209	209

BOD-5007-01-xx
Round built-in lateral body jet



CC	KK	LL	BB
325	423	488	488

RAC-9001-13-xx
1/2"F wall-mount supply elbow



CC	KK	LL	BB
88	114	132	132

RAC-9001-16-xx
1/2"F wall-mount supply elbow



CC	KK	LL	BB
124	161	186	186

COMPLETE SHOWER KITS

PRO-1100-74-xx



Complete thermostatic shower kit on column

CC	KK	LL	BB	NN/YY	VV/TT	GG
2495	3244	3743	3743	3244	3992	5489

Features

- A- Max: 2 gpm - 80 psi (per accessory)
- B- 3-spray hand shower
- C- 2 accessories can work together
- D- Temperature handle on the hot water inlet side, allowing the surface temperature to never exceed the shower water temperature
- E- Shower head arm adjustable up to 20" in height
- F- Easy to move metal slider with built-in hook
- F- Thermostatic cartridge: CAR-2661-00
- G- Diverter cartridge: CAR-3003-36

Ecological options	CEC	Code	Features are the same, except:
		PRO-1100-74-xx-NS	A- Max: 1.75 gpm - 80 psi (per accessory) C- 1 accessory works at a time G- Diverter cartridge: CAR-3003-36-NS

PRO-3420-74-xx

PRR-3420-74-xx*



Complete thermostatic shower kit

CB	KB	LB	BB	NB/YB	VB/TB	GB
2750	3575	4125	4125	3575	4400	6050

Features

- A- 2 accessories kit
- B- Max: 2 gpm - 80 psi (per accessory)
- C- 4-spray hand shower
- D- 2 accessories can work together

Includes

- B74-9404-00-xx** Complete 3/4" thermostatic valve
- B74-9560-02-xx** Complete 2-port diverter with stop
- TET-0812-03-xx** 8" sunflower shower head
- BRA-1812-02-xx** 18" shower arm
- DGL-2160-04-xx** 4-spray sliding shower bar
- RAC-9001-13-xx** Elbow connector

Ecological options	CEC	Codes	Features are the same, except:
		PRO-3420-74-xx-NS	B- Max: 1.75 gpm - 80 psi (per accessory) D- 1 accessory works at a time
		TRO-3420-74-xx-NS + RVA-3404-00-B +	
		RVA-9562-00-NS-B	

TRIM ONLY

TRO-3420-74-xx	CB	KB	LB	BB	NB/YB	VB/TB	GB
TRR-3420-74-xx*	1769	2594	3144	3144	2594	3419	5069

ROUGH VALVES Please order **all** of the following rough valves to complete the trim:

RVA-3404-00-B	Type T rough - 3/4" female NPT connections	682
RVA-9562-00-B	2-port diverter rough - 1/2" male NPT or welded copper connections	299

Finishes :

CC = chrome, KK = matte black, LL = satin brass, BB = white, NN = brushed nickel, YY = polished nickel, TT = venetian bronze, VV = satin copper, GG = gold
CB = chrome white, KB = matte black white, LB = satin brass white, NB = brushed nickel white, YB = polished nickel white, TB = venetian bronze white, VB = satin copper, GB = gold white

AIR B80

Compatible with the Touchless Sensor
Order ELE-2001-01-xx (p. 43)



LEGEND

Order

Items from the AIR collection must be ordered in 2 steps:

- 1- Order the core product (spout + handle rough)
- 2- Order the desired handle trim

You must order both codes to obtain a complete product.



1. Order the core product

B80-8001-1PL-xx

**FAUCET WITHOUT HANDLE
DRAIN INCLUDED**



CC	KK	LL	BB	NN/YY	VV/TT	GG
575	748	863	863	748	920	1265

Available
Q3 2023



The core product includes:

- The faucet spout
- The handle rough

Available in all solid finishes.

8" c/c lavatory faucet, drain included

A- Max: 1.2 gpm - 60 psi

B- Push-button drain with overflow included

C- Laminar stream

D- CAR-3820-01 (Cold), CAR-3820-02 (Hot)

HANDLE OPTIONS Please order **one** of the following handle kits to complete the product (see below for details):

M80-8000-110-xx	Circular handles		M80-8000-330-xx	Symmetrical lever handles	
M80-8000-220-xx	Cross handles		M80-8000-440-xx	Asymmetrical lever handles	

2. Order the desired handle trim

Order

The first letter designates the main finish.
The x designates the color accent.

Prices vary depending on the main finish only.

M80-8000-xx0-xx

HANDLE KIT

Cx	Kx	Lx	Bx	Nx/Yx	Vx/Tx	Gx
250	325	375	375	325	400	550

xx: Finish

The first x is the handle base finish — chrome in this example.

The second x is the handle top finish — matte black in this example.

The finish of this example is therefore CK: chrome matte black



Handle kit for 8" c/c lavatory faucet

A- Handle kit required to complete product

B80-8001-1PL-xx

B- Comes in pair

C- Made of brass parts

M80-8000-110-xx

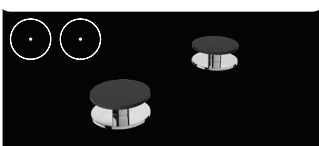

M80-8000-220-xx

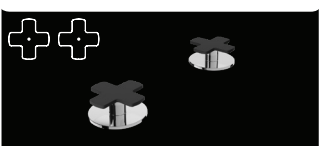

M80-8000-330-xx



M80-8000-440-xx

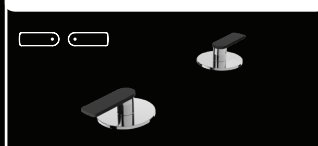

Recommendation

We recommend that the faucet **CORE FINISH** (code B) and the handle base (code M) be the same.

Ex: B80-8001-1PL-CC + M80-8000-110-Cx

However, it is possible to mix and match finishes according to your preferences.

AIR B80

B80-1031-1PL-xx

FAUCET WITHOUT HANDLE DRAIN INCLUDED



CC	KK	LL	BB	NN/YY	VV/TT	GG
570	741	855	855	741	912	1254

Available
Q4 2023

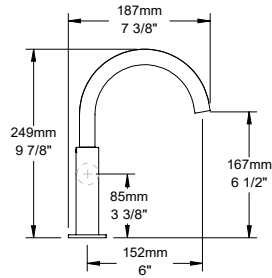

Single-hole lavatory faucet, drain included

- A- Max: 1.2 gpm - 60 psi
- B- Laminar stream
- C- CAR-1025-06
- D- Push-button drain with overflow included

DRAIN NOT INCLUDED

B80-1031-00L-xx

D- Order your lavatory drain (pages 309-310)

CC	KK	LL	BB	NN/YY	VV/TT	GG
522	678	783	783	678	835	1143

HANDLE OPTIONS Please order **one** of the following handle kits to complete the product (see below for details):

M80-1030-10-xx

Circular handle



M80-1030-30-xx

Symmetrical lever handle



M80-1030-20-xx

Cross handle



M80-1030-40-xx

Asymmetrical lever handle



M80-1030-X0-xx

HANDLE KIT

Cx	Kx	Lx	Bx	Nx/Yx	Vx/Tx	Gx
125	163	188	188	163	200	275

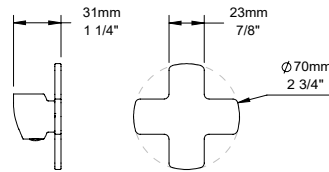

Handle kit for single-hole lavatory faucet

- A- Handle kit required to complete product
- B80-103X-XXL-xx
- B- Made of brass parts

M80-1030-10-xx



M80-1030-20-xx



M80-1030-30-xx



M80-1030-40-xx



ASSEMBLED PRODUCT IMAGES

B80-1031-XXL-xx + M80-1030-10-xx



B80-1031-XXL-xx + M80-1030-20-xx



B80-1031-XXL-xx + M80-1030-30-xx



B80-1031-XXL-xx + M80-1030-40-xx



Finishes:

CC = chrome, KK = matte black, LL = satin brass, BB = white, NN = brushed nickel, YY = polished nickel, TT = venetian bronze, VV = satin copper, GG = gold **233**

AIR B80

B80-1032-1PL-xx

**FAUCET WITHOUT HANDLE
DRAIN INCLUDED**

CEC



CC	KK	LL	BB	NN/YY	VV/TT	GG
570	741	855	855	741	912	1254

Available
Q4 2023

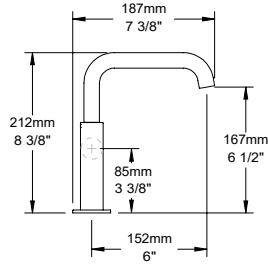

Single-hole lavatory faucet, drain included

- A- Max: 1.2 gpm - 60 psi
- B- Laminar stream
- C- CAR-1025-06
- D- Push-button drain with overflow included

DRAIN NOT INCLUDED

B80-1032-00L-xx

D- Order your lavatory drain (pages 309-310)

CC	KK	LL	BB	NN/YY	VV/TT	GG
522	678	783	783	678	835	1143

HANDLE OPTIONS Please order **one** of the following handle kits to complete the product (see below for details):

M80-1030-10-xx

Circular handle



M80-1030-30-xx

Symmetrical lever handle



M80-1030-20-xx

Cross handle



M80-1030-40-xx

Asymmetrical lever handle



M80-1030-X0-xx

HANDLE KIT

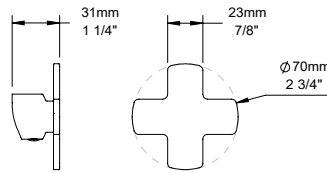

Cx	Kx	Lx	Bx	Nx/Yx	Vx/Tx	Gx
125	163	188	188	163	200	275

Handle kit for single-hole lavatory faucet

- A- Handle kit required to complete product
- B80-103X-XXL-xx
- B- Made of brass parts

M80-1030-10-xx



M80-1030-20-xx



M80-1030-30-xx



M80-1030-40-xx



ASSEMBLED PRODUCT IMAGES

B80-1032-XXL-xx + M80-1030-10-xx



B80-1032-XXL-xx + M80-1030-20-xx



B80-1032-XXL-xx + M80-1030-30-xx



B80-1032-XXL-xx + M80-1030-40-xx

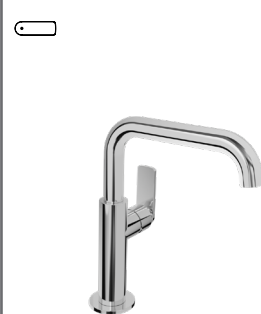

AIR B80

B80-8001-1PL-xx

**FAUCET WITHOUT HANDLE
DRAIN INCLUDED**

CEC

CC	KK	LL	BB	NN/YY	VV/TT	GG
575	748	863	863	748	920	1265

Available Q3 2023

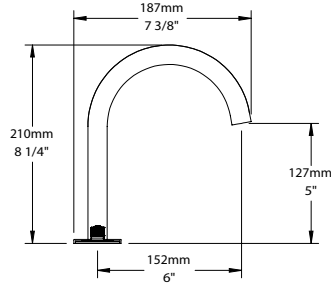

8" c/c lavatory faucet, drain included

- A- Max: 1.2 gpm - 60 psi
- B- Laminar stream
- C- CAR-3820-01 (Cold), CAR-3820-02 (Hot)
- D- Push-button drain with overflow included

HANDLE OPTIONS Please order **one** of the following handle kits to complete the product (see below for details):

M80-8000-110-xx

Circular handles



M80-8000-330-xx

Symmetrical lever handles

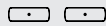

M80-8000-220-xx

Cross handles

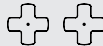

M80-8000-440-xx

Asymmetrical lever handles

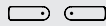

M80-8000-XX0-xx

HANDLE KIT

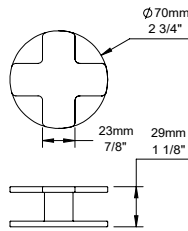

Cx	Kx	Lx	Bx	Nx/Yx	Vx/Tx	Gx
250	325	375	375	325	400	550

Handle kit for 8" c/c lavatory faucet

- A- Handle kit required to complete product B80-800X-1PL-xx et B80-8042-00L-xx
- B- Comes in pair
- C- Made of brass parts

M80-8000-110-xx



M80-8000-220-xx



M80-8000-330-xx



M80-8000-440-xx



ASSEMBLED PRODUCT IMAGES

**B80-8001-1PL-xx +
M80-8000-110-xx**



**B80-8001-1PL-xx +
M80-8000-220-xx**



**B80-8001-1PL-xx +
M80-8000-330-xx**



**B80-8001-1PL-xx +
M80-8000-440-xx**



Finishes:

CC = chrome, KK = matte black, LL = satin brass, BB = white, NN = brushed nickel, YY = polished nickel, TT = venetian bronze, VV = satin copper, GG = gold **235**

AIR B80

B80-8002-1PL-xx

**FAUCET WITHOUT HANDLE
DRAIN INCLUDED**



CC	KK	LL	BB	NN/YY	VV/TT	GG
575	748	863	863	748	920	1265

Available Q3 2023

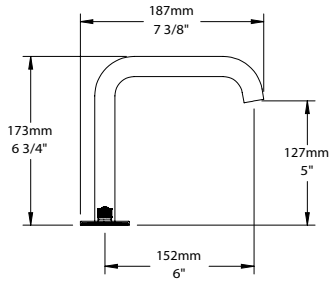

8" c/c lavatory faucet, drain included

- A- Max: 1.2 gpm - 60 psi
- B- Laminar stream
- C- CAR-3820-01 (Cold), CAR-3820-02 (Hot)
- D- Push-button drain with overflow included

HANDLE OPTIONS Please order **one** of the following handle kits to complete the product (see below for details):

M80-8000-110-xx	Circular handles		M80-8000-330-xx	Symmetrical lever handles	
M80-8000-220-xx	Cross handles		M80-8000-440-xx	Asymmetrical lever handles	

M80-8000-XX0-xx

HANDLE KIT

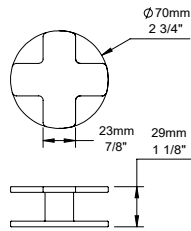

Cx	Kx	Lx	Bx	Nx/Yx	Vx/Tx	Gx
250	325	375	375	325	400	550

Handle kit for 8" c/c lavatory faucet

- A- Handle kit required to complete product
B80-800X-1PL-xx et B80-8042-00L-xx
- B- Comes in pair
- C- Made of brass parts

M80-8000-110-xx	M80-8000-220-xx	M80-8000-330-xx	M80-8000-440-xx

ASSEMBLED PRODUCT IMAGES

B80-8002-1PL-xx + M80-8000-110-xx	B80-8002-1PL-xx + M80-8000-220-xx	B80-8002-1PL-xx + M80-8000-330-xx	B80-8002-1PL-xx + M80-8000-440-xx

AIR B80

B80-8003-1PL-xx

**FAUCET WITHOUT HANDLE
DRAIN INCLUDED**



CC	KK	LL	BB	NN/YY	VV/TT	GG
575	748	863	863	748	920	1265

Available Q3 2023

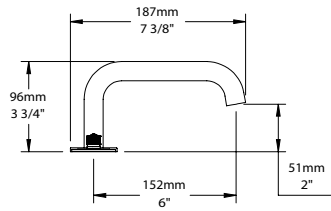

8" c/c lavatory faucet, drain included

- A- Max: 1.2 gpm - 60 psi
- B- Laminar stream
- C- CAR-3820-01 (Cold), CAR-3820-02 (Hot)
- D- Push-button drain with overflow included

HANDLE OPTIONS Please order **one** of the following handle kits to complete the product (see below for details):

M80-8000-110-xx	Circular handles		M80-8000-330-xx	Symmetrical lever handles	
M80-8000-220-xx	Cross handles		M80-8000-440-xx	Asymmetrical lever handles	

M80-8000-XX0-xx HANDLE KIT

Cx	Kx	Lx	Bx	Nx/Yx	Vx/Tx	Gx
250	325	375	375	325	400	550

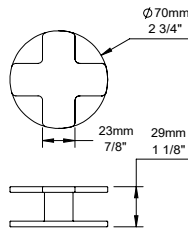

Handle kit for 8" c/c lavatory faucet

- A- Handle kit required to complete product B80-800X-1PL-xx et B80-8042-00L-xx
- B- Comes in pair
- C- Made of brass parts

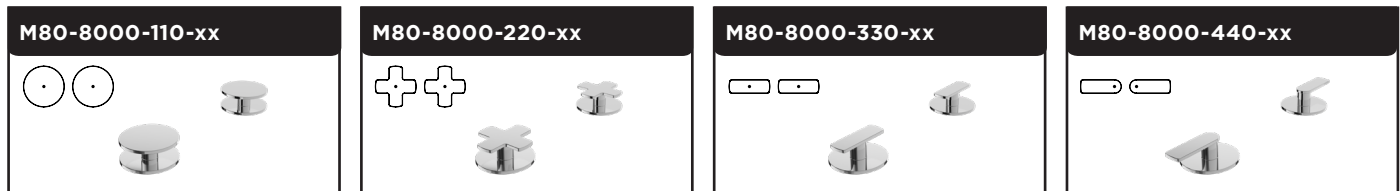

ASSEMBLED PRODUCT IMAGES



Finishes:

CC = chrome, KK = matte black, LL = satin brass, BB = white, NN = brushed nickel, YY = polished nickel, TT = venetian bronze, VV = satin copper, GG = gold **237**

AIR B80

AIR B80

B80-8042-00L-xx

FAUCET WITHOUT HANDLE



CC	KK	LL	BB	NN/YY	VV/TT	GG
575	748	863	863	748	920	1265

Available Q3 2023

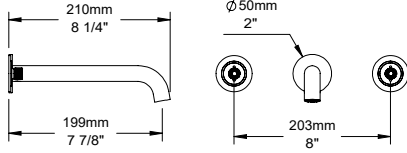
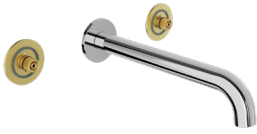

Wall-mounted 8" c/c lavatory faucet, drain not included

- A- 1.2 gpm - 60 psi
- B- 2 choices of aerator included: non-adjustable laminar or adjustable aerated
- C- CAR-1011-80 (Cold), CAR-1011-81 (Hot)
- D- Order your lavatory drain (pages 309-310)
- E- One-piece rough for easy installation
- F- Large depth adjustment range

HANDLE OPTIONS Please order **one** of the following handle kits to complete the product (see below for details):

M80-8000-110-xx

Circular handles



M80-8000-330-xx

Symmetrical lever handles



M80-8000-220-xx

Cross handles

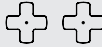

M80-8000-440-xx

Asymmetrical lever handles



M80-8000-XX0-xx

HANDLE KIT

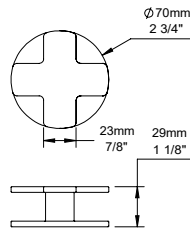

Cx	Kx	Lx	Bx	Nx/Yx	Vx/Tx	Gx
250	325	375	375	325	400	550

Handle kit for wall-mounted 8" c/c lavatory faucet

- A- Handle kit required to complete product B80-800X-1PL-xx et B80-8042-00L-xx
- B- Comes in pair
- C- Made of brass parts

M80-8000-110-xx

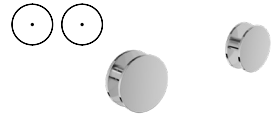

M80-8000-220-xx



M80-8000-330-xx



M80-8000-440-xx



ASSEMBLED PRODUCT IMAGES

B80-8042-00L-xx + M80-8000-110-xx

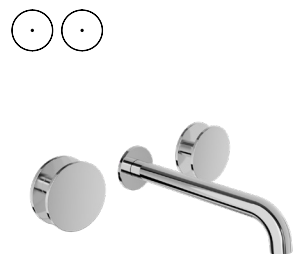

B80-8042-00L-xx + M80-8000-220-xx

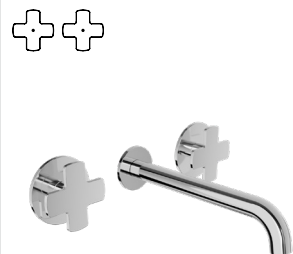

B80-8042-00L-xx + M80-8000-330-xx

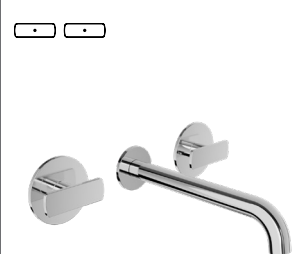

B80-8042-00L-xx + M80-8000-440-xx



AIR B80

B80-8102-00L-xx

FAUCET WITHOUT HANDLE

CEC



CC	KK	LL	BB	NN/YY	VV/TT	GG
625	813	938	938	813	1000	1375

Available Q3 2023

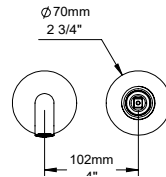
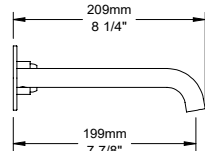

Single lever wall-mounted lavatory faucet, drain not included

- A- 1.2 gpm - 60 psi
- B- 2 choices of aerator included: non-adjustable laminar or adjustable aerated
- C- CAR-1025-09
- D- Order your lavatory drain (pages 309-310)
- E- One-piece rough for easy installation
- F- Large depth adjustment range

HANDLE OPTIONS Please order **one** of the following handle kits to complete the product (see below for details):

M80-8100-10-xx

Circular handle



M80-8100-30-xx

Symmetrical lever handle



M80-8100-20-xx

Cross handle



M80-8100-40-xx

Asymmetrical lever handle



M80-8100-X0-xx

HANDLE KIT

Cx	Kx	Lx	Bx	Nx/Yx	Vx/Tx	Gx
125	163	188	188	163	200	275

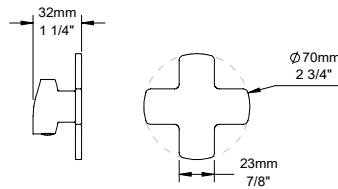

Handle kit for single lever wall-mounted lavatory faucet

- A- Handle kit required to complete product B80-8102-00L-xx
- B- Made of brass parts

M80-8100-10-xx



M80-8100-20-xx



M80-8100-30-xx



M80-8100-40-xx



ASSEMBLED PRODUCT IMAGES

B80-8102-00L-xx +
M80-8100-10-xx



B80-8102-00L-xx +
M80-8100-20-xx



B80-8102-00L-xx +
M80-8100-30-xx



B80-8102-00L-xx +
M80-8100-40-xx



Finishes:

CC = chrome, KK = matte black, LL = satin brass, BB = white, NN = brushed nickel, YY = polished nickel, TT = venetian bronze, VV = satin copper, GG = gold 239

AIR B80

B80-1101-00-xx

FAUCET WITHOUT HANDLE

CEC

Available Q3 2023

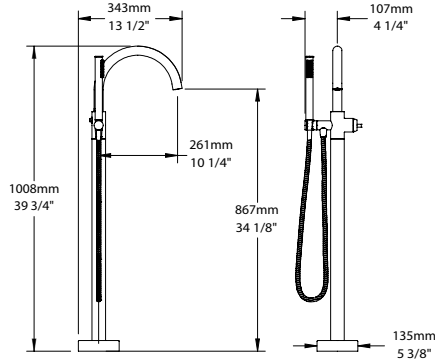

Floor-mounted tub filler with hand shower

Bath spout:

A- 7.1 gpm - 60 psi

B- Tub spout with integrated push-button diverter

Hand shower:

C- Max: 1.75 gpm - 80 psi

D- Reclining hand shower holder

E- DOU-2604-01-xx with 59" hose

F- PVC hose in KK finish or brass for other finishes

G- CAR-1060-01

Ecological options

Codes	Reduced flow rates
B80-1101-00-xx-150	1.5 gpm (5.7 l/min) - 80 psi

TRIM ONLY

T80-1101-00-xx



MOUNTING KIT Please order the following kit to complete the trim:

FIX-1100-00-B

Floor mounting kit for floor-mounted tub filler with hand shower

CC	KK	LL	BB	NN/YY	VV/TT	GG
2022	2669	3101	3101	2669	3316	4610

135

HANDLE OPTIONS Please order **one** of the following handle kits to complete the product (see below for details):

M80-1100-10-xx

Circular handle



M80-1100-30-xx

Symmetrical lever handle



M80-1100-20-xx

Cross handle



M80-1100-40-xx

Asymmetrical lever handle



M80-1100-X0-xx

HANDLE KIT

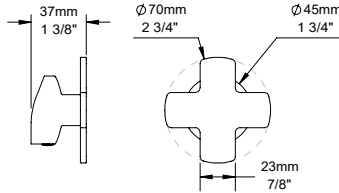

Cx	Kx	Lx	Bx	Nx/Yx	Vx/Tx	Gx
125	163	188	188	163	200	275

Handle kit for floor-mounted tub filler with hand shower

A- Handle kit required to complete product

B80-110X-00-xx

B- Made of brass parts

M80-1100-10-xx



M80-1100-20-xx



M80-1100-30-xx



M80-1100-40-xx



ASSEMBLED PRODUCT IMAGES

B80-1101-00-xx + M80-1100-10-xx



B80-1101-00-xx + M80-1100-20-xx



B80-1101-00-xx + M80-1100-30-xx



B80-1101-00-xx + M80-1100-40-xx



B80-1102-00-xx

FAUCET WITHOUT HANDLE

CEC

Available Q3 2023

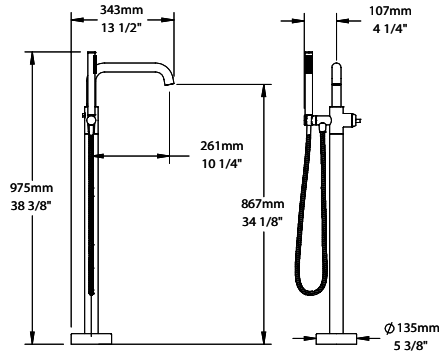

CC	KK	LL	BB	NN/YY	VV/TT	GG
2157	2804	3236	3236	2804	3451	4745

Floor-mounted tub filler with hand shower

Bath spout:

A- 7.1 gpm - 60 psi

B- Tub spout with integrated push-button diverter

Hand shower:

C- Max: 1.75 gpm - 80 psi

D- Reclining hand shower holder

E- DOU-2604-01-xx with 59" hose

F- PVC hose in KK finish or brass for other finishes

G- CAR-1060-01

Ecological options

Codes	Reduced flow rates
B80-1102-00-xx-150	1.5 gpm (5.7 l/min) - 80 psi

TRIM ONLY

T80-1102-00-xx

CC	KK	LL	BB	NN/YY	VV/TT	GG
2022	2669	3101	3101	2669	3316	4610



MOUNTING KIT Please order the following kit to complete the trim:

FIX-1100-00-B

Floor mounting kit for floor-mounted tub filler with hand shower

135

HANDLE OPTIONS Please order one of the following handle kits to complete the product (see below for details):

M80-1100-10-xx

Circular handle



M80-1100-30-xx

Symmetrical lever handle



M80-1100-20-xx

Cross handle



M80-1100-40-xx

Asymmetrical lever handle



M80-1100-X0-xx

HANDLE KIT

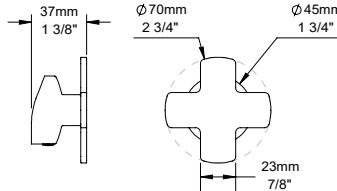

Cx	Kx	Lx	Bx	Nx/Yx	Vx/Tx	Gx
125	163	188	188	163	200	275

Handle kit for floor-mounted tub filler with hand shower

A- Handle kit required to complete product

B80-110X-00-xx

B- Made of brass parts

M80-1100-10-xx



M80-1100-20-xx



M80-1100-30-xx



M80-1100-40-xx



ASSEMBLED PRODUCT IMAGES

B80-1102-00-xx +
M80-1100-10-xx



B80-1102-00-xx +
M80-1100-20-xx



B80-1102-00-xx +
M80-1100-30-xx



B80-1102-00-xx +
M80-1100-40-xx



Finishes:

CC = chrome, KK = matte black, LL = satin brass, BB = white, NN = brushed nickel, YY = polished nickel, TT = venetian bronze, VV = satin copper, GG = gold 241

LEGEND

Order

Product from the AIR collection must be ordered in 2 steps:

- 1- Items the core product (wall plate + handle rough)
- 2- Order the desired handle trim

You must order both codes to obtain a complete product.

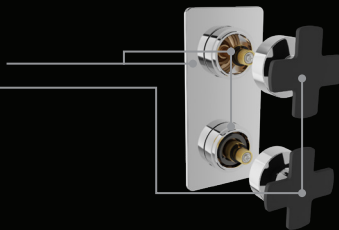

1. Order the core product

B80-9522-00-xx

VALVE WITHOUT HANDLE

CC	KK	LL	BB	NN/YY	VV/TT	GG
1050	1160	1233	1233	1160	1269	1488

Available Q3 2023



The core product includes:

- The wall plate or flange
- The handle rough

Available in all solid finishes.

Thermostatic pressure balanced shower valve with 2-way diverter without handle (shared port)

- A - 1 outlet: 7.9 gpm - 60 psi, 2 outlets: 3.7 gpm - 60 psi
- B - Up to 2 accessories can be used at the same time
- C - Thin brass plate
- D - Reversible check / non-return valves in case of water supply inversion
- E - CAR-2661-00 (temperature), CAR-3003-36 (diverter)
- F - Rough valve RVA-9521-00-B included
- G - Large depth adjustment range

Ecological options **CEC**

Codes	Features
B80-9522-00-xx-NS	Non-shared port
T80-9522-00-xx + RVA-9521-00-NS-B	1 accessory works at a time
T80-9522-00-xx + RVA-9521-PO-NS-B	CAR-3003-36-NS (diverter)

HANDLE OPTIONS Please order **one** of the following handle kits to complete the product (see below for details):

M80-9520-110-xx



M80-9520-120-xx



M80-9520-130-xx



M80-9520-220-xx



M80-9520-230-xx



M80-9520-330-xx



2. Order the desired handle trim

Order

The first letter designates the main finish.
The x designates the color accent.

Prices vary depending on the main finish only.

M80-9520-XX0-xx

HANDLE KITS

Cx	Kx	Lx	Bx	Nx/Yx	Vx/Tx	Gx
250	325	375	375	325	400	550

xx: Finish

The first x is the handle base finish — chrome in this example.

The second x is the handle top finish — matte black in this example.

The finish of this example is therefore CK: chrome matte black

Handle kit for thermostatic pressure balanced shower valve with 2-way diverter

- A - Handle kit required to complete product B80-952X-00-xx and B80-953X-00-xx
- B - Comes in pair
- C - Made of brass parts

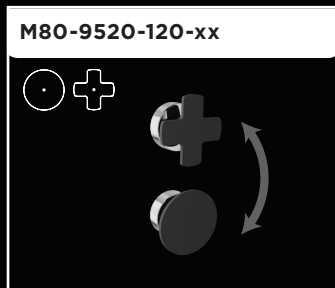
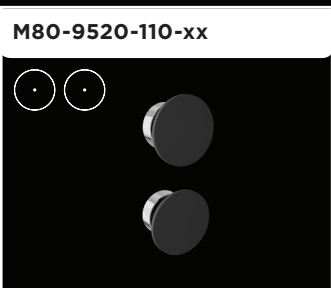

The arrow indicates that the handle trims are interchangeable and can be installed on the top or bottom of the TP valves.

Recommendation

We recommend that the faucet **CORE FINISH (code B)** and the handle base **(code M)** be the same.

Ex: B80-9522-00-CC + M80-9520-XX0-Cx

However, it is possible to mix and match finishes according to your preferences.

Actual products may differ from pictures. Actual products measures may differ from the measures shown. All USD prices are subject to change without notice. Effective as of August 2023.

B80-9101-00-xx

VALVE WITHOUT HANDLE

Available Q3 2023

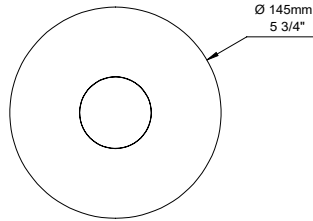
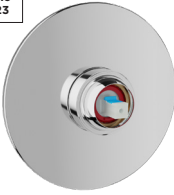

CC	KK	LL	BB	NN/YY	VV/TT	GG
522	586	628	628	586	649	776

Pressure balanced shower control valve without handle

- A- 6 gpm - 60 psi
- B- Volume control valve
- C- Thin brass plate
- D- CAR-1020-40
- E- Rough valve RVA-9020-00-B included

TRIM ONLY

T80-9101-00-xx

CC	KK	LL	BB	NN/YY	VV/TT	GG
212	276	318	318	276	339	466

ROUGH VALVES Please order **one** of the following rough valves to complete the trim:

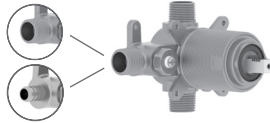

RVA-9020-00-B

Type P rough - 1/2" male NPT or welded copper connections

310

RVA-9020-PO-B

Type P rough - PEX connections

310

HANDLE OPTIONS Please order **one** of the following handle kits to complete the product (see below for details):

M80-9100-10-xx

Circular handle



M80-9100-30-xx

Symmetrical lever handle



M80-9100-20-xx

Cross handle



M80-9100-40-xx

Asymmetrical lever handle



M80-9100-X0-xx

HANDLE KIT

Cx	Kx	Lx	Bx	Nx/Yx	Vx/Tx	Gx
125	163	188	188	163	200	275

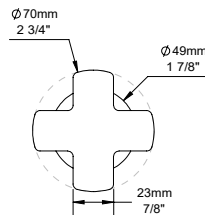

Handle kit for pressure balanced shower control valve

- A- Handle kit required to complete product B80-910X-00-xx
- B- Made of brass parts

M80-9100-10-xx

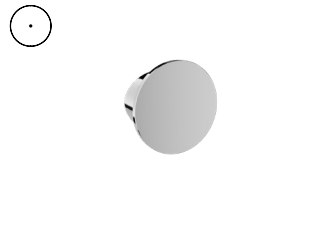

M80-9100-20-xx



M80-9100-30-xx



M80-9100-40-xx



ASSEMBLED PRODUCT IMAGES

B80-9101-00-xx + M80-9100-10-xx

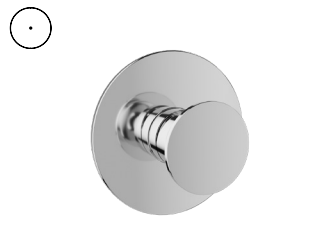

B80-9101-00-xx + M80-9100-20-xx

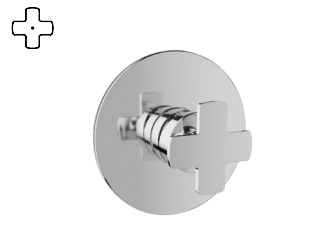

B80-9101-00-xx + M80-9100-30-xx

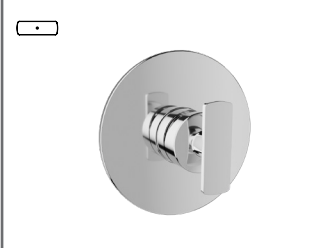

B80-9101-00-xx + M80-9100-40-xx



Finishes:

CC = chrome, KK = matte black, LL = satin brass, BB = white, NN = brushed nickel, YY = polished nickel, TT = venetian bronze, VV = satin copper, GG = gold 243

AIR B80

B80-9102-00-xx

VALVE WITHOUT HANDLE

Available Q3 2023

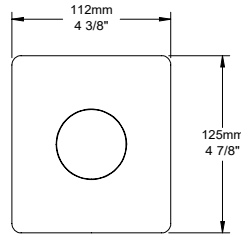

CC	KK	LL	BB	NN/YY	VV/TT	GG
522	586	628	628	586	649	776

Pressure balanced shower control valve without handle

- A- 6 gpm - 60 psi
- B- Volume control valve
- C- Thin brass plate
- D- CAR-1020-40
- E- Rough valve RVA-9020-00-B included

TRIM ONLY

T80-9102-00-xx

CC	KK	LL	BB	NN/YY	VV/TT	GG
212	276	318	318	276	339	466

ROUGH VALVES Please order **one** of the following rough valves to complete the trim:

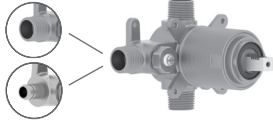

RVA-9020-00-B

Type P rough - 1/2" male NPT or welded copper connections

310

RVA-9020-P0-B

Type P rough - PEX connections

310

HANDLE OPTIONS Please order **one** of the following handle kits to complete the product (see below for details):

M80-9100-10-xx

Circular handle



M80-9100-30-xx

Symmetrical lever handle



M80-9100-20-xx

Cross handle



M80-9100-40-xx

Asymmetrical lever handle



M80-9100-X0-xx

HANDLE KIT

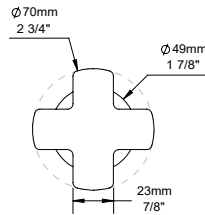

Cx	Kx	Lx	Bx	Nx/Yx	Vx/Tx	Gx
125	163	188	188	163	200	275

Handle kit for pressure balanced shower control valve

- A- Handle kit required to complete product B80-910X-00-xx
- B- Made of brass parts

M80-9100-10-xx

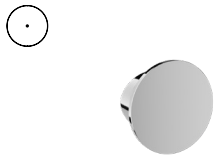

M80-9100-20-xx

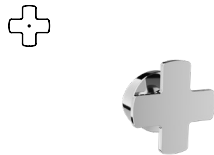

M80-9100-30-xx



M80-9100-40-xx



ASSEMBLED PRODUCT IMAGES

B80-9102-00-xx + M80-9100-10-xx

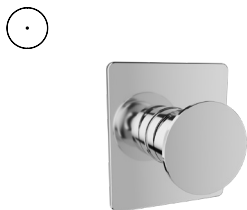

B80-9102-00-xx + M80-9100-20-xx



B80-9102-00-xx + M80-9100-30-xx



B80-9102-00-xx + M80-9100-40-xx



B80-9181-00-xx

VALVE WITHOUT HANDLE

Available Q3 2023

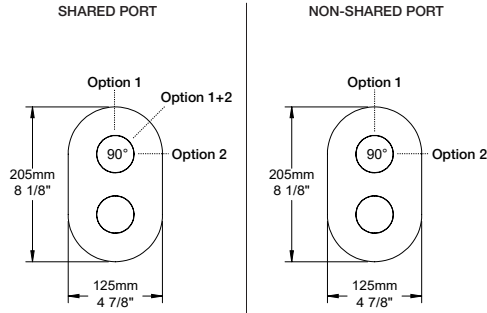

CC	KK	LL	BB	NN/YY	VV/TT	GG
749	832	887	887	832	914	1079

Pressure balanced shower control valve with 2-way diverter without handle (shared port)

- A- 1 outlet: 5 gpm - 60 psi, 2 outlets: 2.6 gpm - 60 psi
- B- Volume control valve
- C- Up to 2 accessories can be used at the same time
- D- Thin brass plate
- E- CAR-1020-40 (volume), CAR-1001-35 (diverter)
- F- Rough valve RVA-9181-00-B included

Ecological options CEC

Codes	Features
B80-9181-00-xx-NS	Non-shared port
T80-9181-00-xx + RVA-9181-00-NS-B	1 accessory works at a time
T80-9181-00-xx + RVA-9181-P0-NS-B	CAR-1001-35-NS (diverter)

TRIM ONLY

T80-9181-00-xx

CC	KK	LL	BB	NN/YY	VV/TT	GG
275	358	413	413	358	440	605

ROUGH VALVES Please order **one** of the following rough valves to complete the trim:

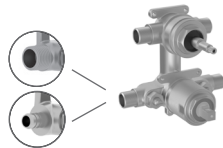

RVA-9181-00-B

2-way type P rough - 1/2" male NPT or welded copper connections

474

RVA-9181-P0-B

2-way type P rough - PEX connections

474

HANDLE OPTIONS Please order **one** of the following handle kits to complete the product (see below for details):

M80-9180-14-xx



M80-9180-24-xx



M80-9180-34-xx



M80-9180-X4-xx

HANDLE KIT

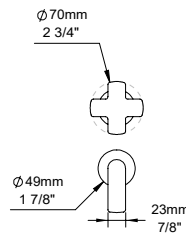

Cx	Kx	Lx	Bx	Nx/Yx	Vx/Tx	Gx
250	325	375	375	325	400	550

Handle kit for pressure balanced shower control valve with diverter

- A- Handle kit required to complete product B80-918X-00-xx and B80-919X-00-xx
- B- Comes in pair
- C- Made of brass parts

M80-9180-14-xx

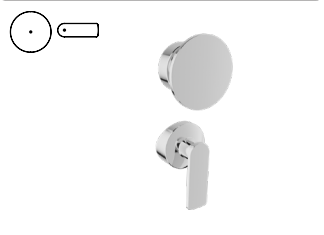

M80-9180-24-xx

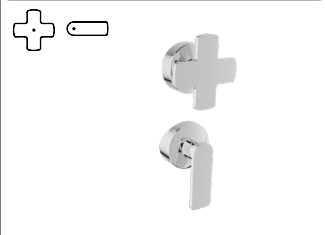

M80-9180-34-xx

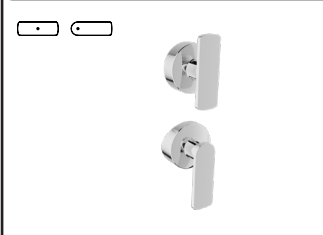

ASSEMBLED PRODUCT IMAGES

B80-9181-00-xx + M80-9180-14-xx



B80-9181-00-xx + M80-9180-24-xx

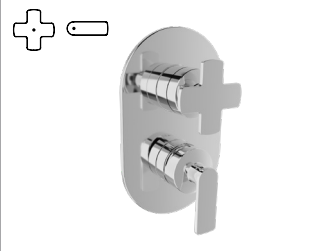

B80-9181-00-xx + M80-9180-34-xx

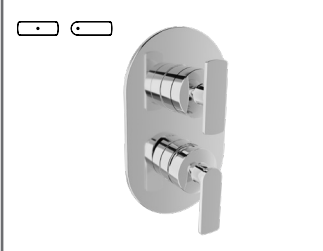

Finishes:

CC = chrome, KK = matte black, LL = satin brass, BB = white, NN = brushed nickel, YY = polished nickel, TT = venetian bronze, VV = satin copper, GG = gold 245

AIR B80

B80-9182-00-xx

VALVE WITHOUT HANDLE

CC	KK	LL	BB	NN/YY	VV/TT	GG
749	832	887	887	832	914	1079

Available Q3 2023

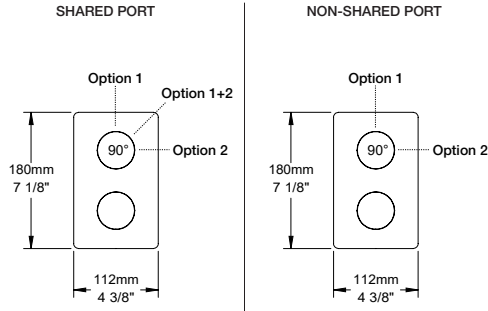

Pressure balanced shower control valve with 2-way diverter without handle (shared port)

- A- 1 outlet: 5 gpm - 60 psi, 2 outlets: 2.6 gpm - 60 psi
- B- Volume control valve
- C- Up to 2 accessories can be used at the same time
- D- Thin brass plate
- E- CAR-1020-40 (volume), CAR-1001-35 (diverter)
- F- Rough valve RVA-9181-00-B included

Ecological options CEC

Codes	Features
B80-9182-00-xx-NS	Non-shared port
T80-9182-00-xx + RVA-9181-00-NS-B	1 accessory works at a time
T80-9182-00-xx + RVA-9181-P0-NS-B	CAR-1001-35-NS (diverter)

TRIM ONLY

T80-9182-00-xx

CC	KK	LL	BB	NN/YY	VV/TT	GG
275	358	413	413	358	440	605

ROUGH VALVES Please order **one** of the following rough valves to complete the trim:

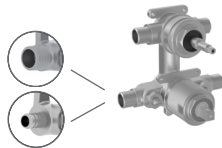

RVA-9181-00-B

2-way type P rough - 1/2" male NPT or welded copper connections

474

RVA-9181-P0-B

2-way type P rough - PEX connections

474

HANDLE OPTIONS Please order **one** of the following handle kits to complete the product (see below for details):

M80-9180-14-xx



M80-9180-24-xx

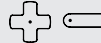

M80-9180-34-xx



M80-9180-X4-xx

HANDLE KIT

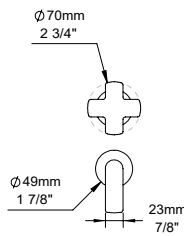

Cx	Kx	Lx	Bx	Nx/Yx	Vx/Tx	Gx
250	325	375	375	325	400	550

Handle kit for pressure balanced shower control valve with diverter

- A- Handle kit required to complete product B80-918X-00-xx and B80-919X-00-xx
- B- Comes in pair
- C- Made of brass parts

M80-9180-14-xx

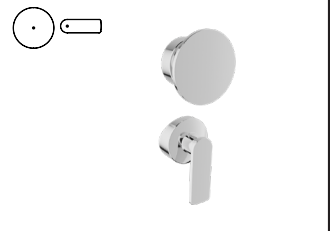

M80-9180-24-xx

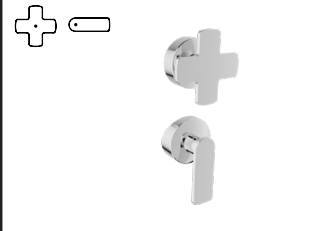

M80-9180-34-xx

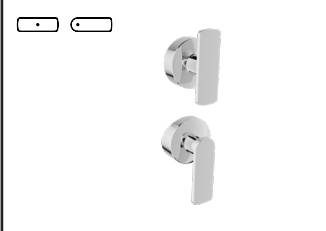

ASSEMBLED PRODUCT IMAGES

B80-9182-00-xx + M80-9180-14-xx

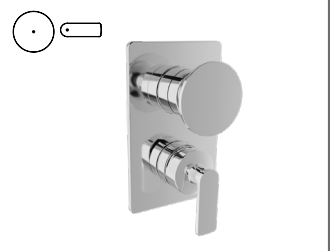

B80-9182-00-xx + M80-9180-24-xx

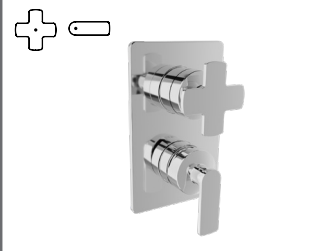

B80-9182-00-xx + M80-9180-34-xx

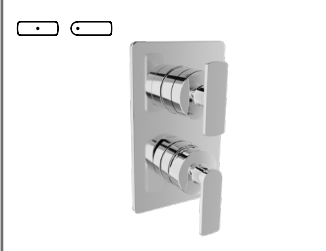

B80-9191-00-xx

VALVE WITHOUT HANDLE

Available Q3 2023

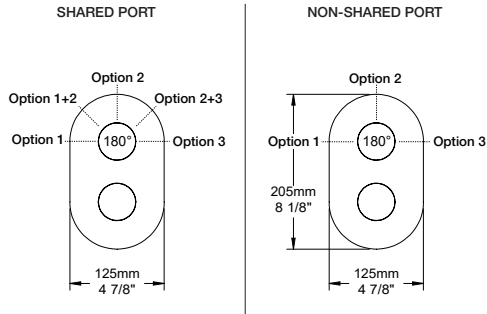

CC	KK	LL	BB	NN/YY	VV/TT	GG
804	887	942	942	887	969	1134

Pressure balanced shower control valve with 3-way diverter without handle (shared port)

- A- 1 outlet: 5 gpm - 60 psi, 2 outlets: 2.6 gpm - 60 psi
- B- Volume control valve
- C- Up to 2 accessories can be used at the same time
- D- Thin brass plate
- E- CAR-1020-40 (volume), CAR-9220-02 (diverter)
- F- Rough valve RVA-9191-00-B included

Ecological options CEC

Codes	Features
B80-9191-00-xx-NS	Non-shared port
T80-9191-00-xx + RVA-9191-00-NS-B	1 accessory works at a time
T80-9191-00-xx + RVA-9191-PO-NS-B	CAR-9220-02-NS (diverter)

TRIM ONLY

T80-9191-00-xx

CC	KK	LL	BB	NN/YY	VV/TT	GG
275	358	413	413	358	440	605

ROUGH VALVES Please order **one** of the following rough valves to complete the trim:

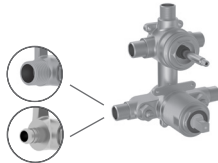

RVA-9191-00-B

2-way type P rough - 1/2" male NPT or welded copper connections

529

RVA-9191-PO-B

2-way type P rough - PEX connections

529

HANDLE OPTIONS Please order **one** of the following handle kits to complete the product (see below for details):

M80-9180-14-xx



M80-9180-24-xx



M80-9180-34-xx



M80-9180-X4-xx

HANDLE KIT

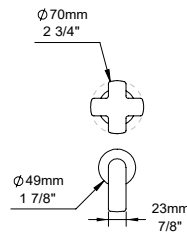

Cx	Kx	Lx	Bx	Nx/Yx	Vx/Tx	Gx
250	325	375	375	325	400	550

Handle kit for pressure balanced shower control valve with diverter

- A- Handle kit required to complete product B80-918X-00-xx and B80-919X-00-xx
- B- Comes in pair
- C- Made of brass parts

M80-9180-14-xx

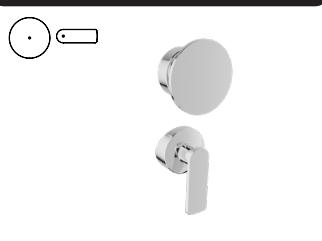

M80-9180-24-xx

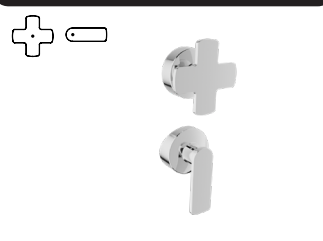

M80-9180-34-xx



ASSEMBLED PRODUCT IMAGES

B80-9191-00-xx + M80-9180-14-xx



B80-9191-00-xx + M80-9180-24-xx

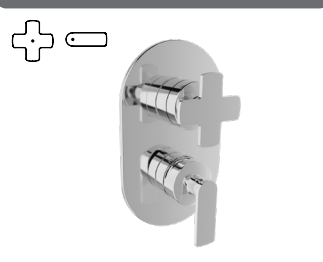

B80-9191-00-xx + M80-9180-34-xx



Finishes:

CC = chrome, KK = matte black, LL = satin brass, BB = white, NN = brushed nickel, YY = polished nickel, TT = venetian bronze, VV = satin copper, GG = gold 247

AIR B80

B80-9192-00-xx

VALVE WITHOUT HANDLE

CC	KK	LL	BB	NN/YY	VV/TT	GG
804	887	942	942	887	969	1134

Available Q3 2023

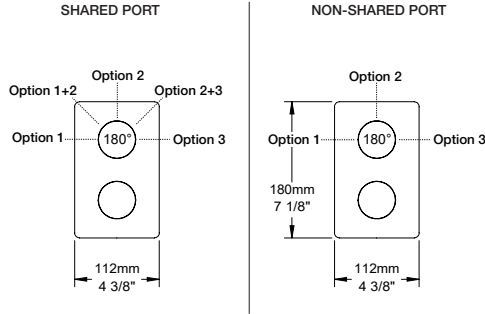

Pressure balanced shower control valve with 3-way diverter without handle (shared port)

- A- 1 outlet: 5 gpm - 60 psi, 2 outlets: 2.6 gpm - 60 psi
- B- Volume control valve
- C- Up to 2 accessories can be used at the same time
- D- Thin brass plate
- E- CAR-1020-40 (volume), CAR-9220-02 (diverter)
- F- Rough valve RVA-9191-00-B included

Ecological options CEC

Codes	Features
B80-9192-00-xx-NS	Non-shared port
T80-9192-00-xx + RVA-9191-00-NS-B	1 accessory works at a time
T80-9192-00-xx + RVA-9191-P0-NS-B	CAR-9220-02-NS (diverter)

TRIM ONLY

T80-9192-00-xx

CC	KK	LL	BB	NN/YY	VV/TT	GG
275	358	413	413	358	440	605

ROUGH VALVES Please order **one** of the following rough valves to complete the trim:

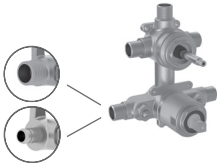

RVA-9191-00-B	2-way type P rough - 1/2" male NPT or welded copper connections	529
RVA-9191-P0-B	2-way type P rough - PEX connections	529

HANDLE OPTIONS Please order **one** of the following handle kits to complete the product (see below for details):

M80-9180-14-xx



M80-9180-24-xx

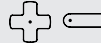

M80-9180-34-xx



M80-9180-X4-xx

HANDLE KIT

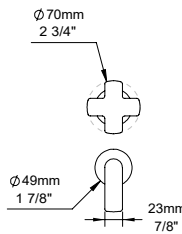

Cx	Kx	Lx	Bx	Nx/Yx	Vx/Tx	Gx
250	325	375	375	325	400	550

Handle kit for pressure balanced shower control valve with diverter

- A- Handle kit required to complete product
B80-918X-00-xx and B80-919X-00-xx
- B- Comes in pair
- C- Made of brass parts

M80-9180-14-xx

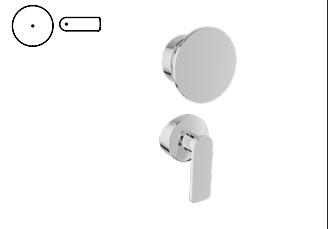

M80-9180-24-xx

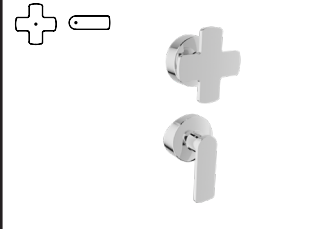

M80-9180-34-xx

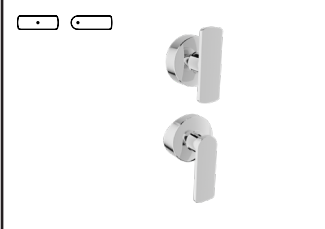

ASSEMBLED PRODUCT IMAGES

B80-9192-00-xx + M80-9180-14-xx

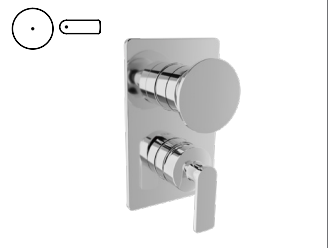

B80-9192-00-xx + M80-9180-24-xx

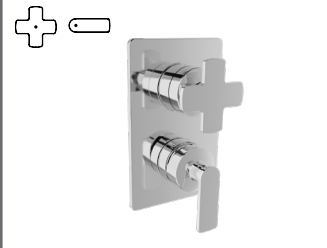

B80-9192-00-xx + M80-9180-34-xx

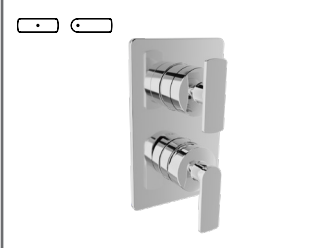

B80-9401-00-xx

VALVE WITHOUT HANDLE

Available Q3 2023

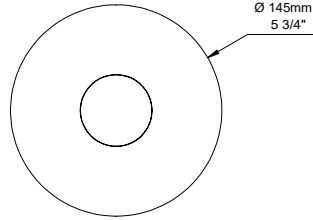

CC	KK	LL	BB	NN/YY	VV/TT	GG
1107	1235	1320	1320	1235	1362	1617

3/4" thermostatic valve without handle

- A- 16 gpm - 60 psi
- B- Separate volume control or diverter valve required
- C- Can easily supply 3 accessories
- D- Thin brass plate
- E- CAR-3404-00
- F- Rough valve RVA-3404-00-B included
- G- Reversible check / non-return valves in case of water supply inversion

TRIM ONLY

T80-9401-00-xx

CC	KK	LL	BB	NN/YY	VV/TT	GG
425	553	638	638	553	680	935



ROUGH VALVE Please order the following rough valve to complete the trim:

RVA-3404-00-B

Type T rough - 3/4" female NPT connections

682

HANDLE OPTIONS Please order **one** of the following handle kits to complete the product (see below for details):

M80-9400-10-xx

Circular handle



M80-9400-30-xx

Symmetrical lever handle



M80-9400-20-xx

Cross handle



M80-9400-40-xx

Asymmetrical lever handle



M80-9400-X0-xx

HANDLE KIT

Cx	Kx	Lx	Bx	Nx/Yx	Vx/Tx	Gx
125	163	188	188	163	200	275

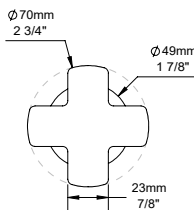

Handle kit for 3/4" thermostatic valve

- A- Handle kit required to complete product B80-940X-00-xx
- B- Made of brass parts

M80-9400-10-xx

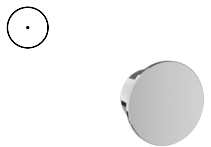

M80-9400-20-xx

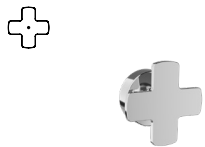

M80-9400-30-xx

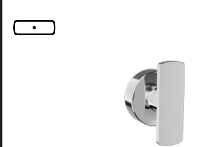

M80-9400-40-xx



ASSEMBLED PRODUCT IMAGES

B80-9401-00-xx + M80-9400-10-xx

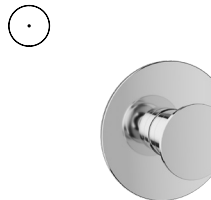

B80-9401-00-xx + M80-9400-20-xx

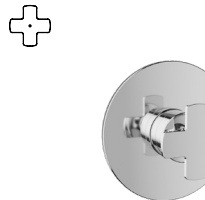

B80-9401-00-xx + M80-9400-30-xx

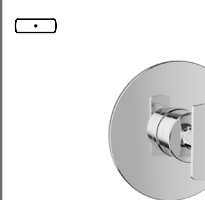

B80-9401-00-xx + M80-9400-40-xx

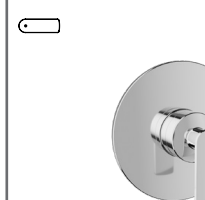

Finishes:

CC = chrome, KK = matte black, LL = satin brass, BB = white, NN = brushed nickel, YY = polished nickel, TT = venetian bronze, VV = satin copper, GG = gold 249

AIR B80

B80-9402-00-xx

VALVE WITHOUT HANDLE

Available Q3 2023

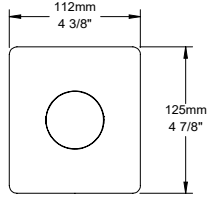

CC	KK	LL	BB	NN/YY	VV/TT	GG
1107	1235	1320	1320	1235	1362	1617

3/4" thermostatic valve without handle

- A- 16 gpm - 60 psi
- B- Separate volume control or diverter valve required
- C- Can easily supply 3 accessories
- D- Thin brass plate
- E- CAR-3404-00
- F- Rough valve RVA-3404-00-B included
- G- Reversible check / non-return valves in case of water supply inversion

TRIM ONLY

T80-9402-00-xx

CC	KK	LL	BB	NN/YY	VV/TT	GG
425	553	638	638	553	680	935



ROUGH VALVE Please order the following rough valve to complete the trim:

RVA-3404-00-B

Type T rough - 3/4" female NPT connections

682

HANDLE OPTIONS Please order **one** of the following handle kits to complete the product (see below for details):

M80-9400-10-xx

Circular handle



M80-9400-30-xx

Symmetrical lever handle



M80-9400-20-xx

Cross handle



M80-9400-40-xx

Asymmetrical lever handle



M80-9400-X0-xx

HANDLE KIT

Cx	Kx	Lx	Bx	Nx/Yx	Vx/Tx	Gx
125	163	188	188	163	200	275

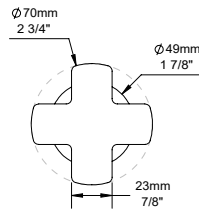

Handle kit for 3/4" thermostatic valve

- A- Handle kit required to complete product B80-940X-00-xx
- B- Made of brass parts

M80-9400-10-xx

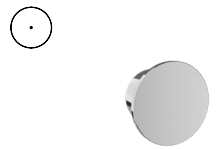

M80-9400-20-xx



M80-9400-30-xx



M80-9400-40-xx



ASSEMBLED PRODUCT IMAGES

B80-9402-00-xx + M80-9400-10-xx

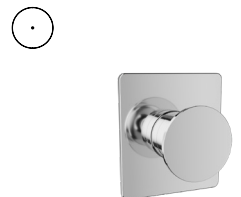

B80-9402-00-xx + M80-9400-20-xx

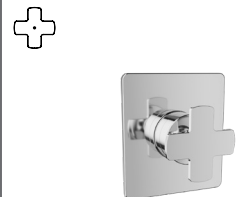

B80-9402-00-xx + M80-9400-30-xx



B80-9402-00-xx + M80-9400-40-xx



B80-9453-00-xx

VALVE WITHOUT HANDLE

Available Q3 2023

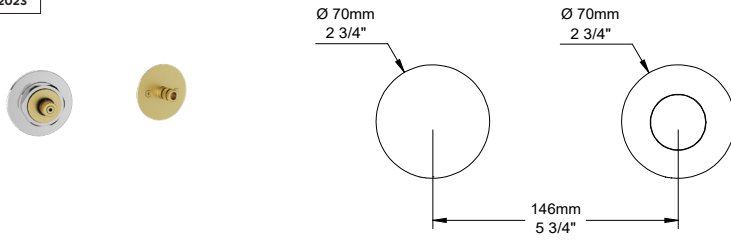

CC	KK	LL	BB	NN/YY	VV/TT	GG
1074	1202	1287	1287	1202	1329	1584

3/4" thermostatic valve without handle

- A- 9 gpm - 60 psi
- B- Separate volume control or diverter valve required
- C- Can easily supply 3 accessories
- D- Hook on the side of the valve can be removed to give access to the check valves
- E- Reversible check / non-return valves in case of water supply inversion
- F- CAR-2661-00
- G- Rough valve RVA-3453-00-B included
- H- Large depth adjustment range

TRIM ONLY

T80-9453-00-xx

CC	KK	LL	BB	NN/YY	VV/TT	GG
425	553	638	638	553	680	935

ROUGH VALVE Please order the following rough valve to complete the trim:

RVA-3453-00-B

Type T rough - 3/4" female NPT connections

649

HANDLE OPTIONS Please order **one** of the following handle kits to complete the product (see below for details):

M80-9453-10-xx

Circular handle



M80-9453-30-xx

Symmetrical lever handle



M80-9453-20-xx

Cross handle



M80-9453-40-xx

Asymmetrical lever handle



M80-9453-X0-xx

HANDLE KIT

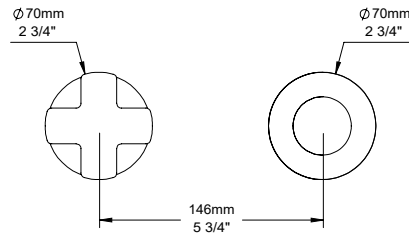

Cx	Kx	Lx	Bx	Nx/Yx	Vx/Tx	Gx
350	456	526	526	456	560	770

Handle kit for 3/4" thermostatic valve

- A- Handle kit required to complete product B80-9453-00-xx
- B- Made of brass parts
- C- Hook accessory covers up the check valves

M80-9453-10-xx



M80-9453-20-xx



M80-9453-30-xx



M80-9453-40-xx



ASSEMBLED PRODUCT IMAGES

B80-9453-00-xx + M80-9453-10-xx



B80-9453-00-xx + M80-9453-20-xx



B80-9453-00-xx + M80-9453-30-xx



B80-9453-00-xx + M80-9453-40-xx



Finishes:

CC = chrome, KK = matte black, LL = satin brass, BB = white, NN = brushed nickel, YY = polished nickel, TT = venetian bronze, VV = satin copper, GG = gold 251

AIR B80

B80-9521-00-xx

VALVE WITHOUT HANDLE

CC	KK	LL	BB	NN/YY	VV/TT	GG
1050	1160	1233	1233	1160	1269	1488

Available Q3 2023

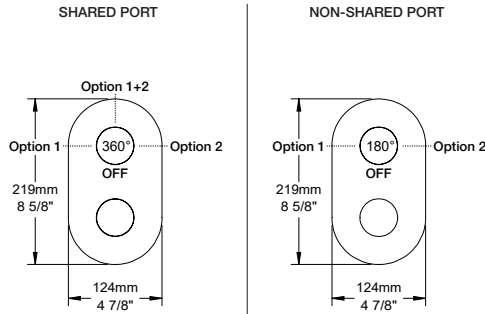

Thermostatic pressure balanced shower valve with 2-way diverter without handle (shared port)

- A- 1 outlet: 7.9 gpm - 60 psi, 2 outlets: 3.7 gpm - 60 psi
- B- Up to 2 accessories can be used at the same time
- C- Thin brass plate
- D- Reversible check / non-return valves in case of water supply inversion
- E- CAR-2661-00 (temperature), CAR-3003-36 (diverter)
- F- Rough valve RVA-9521-00-B included
- G- Large depth adjustment range

Ecological options CEC

Codes	Features
B80-9521-00-xx-NS	Non-shared port
T80-9521-00-xx + RVA-9521-00-NS-B	1 accessory works at a time
T80-9521-00-xx + RVA-9521-PO-NS-B	CAR-3003-36-NS (diverter)

TRIM ONLY

T80-9521-00-xx

CC	KK	LL	BB	NN/YY	VV/TT	GG
365	475	548	548	475	584	803

ROUGH VALVES Please order **one** of the following rough valves to complete the trim:

RVA-9521-00-B

2-way TP rough - 1/2" male NPT or welded copper connections

685

RVA-9521-PO-B

2-way TP rough - PEX connections

685

HANDLE OPTIONS Please order **one** of the following handle kits to complete the product (see below for details):

M80-9520-110-xx



M80-9520-120-xx



M80-9520-130-xx



M80-9520-220-xx



M80-9520-230-xx



M80-9520-330-xx



M80-9520-XX0-xx

HANDLE KIT

Cx	Kx	Lx	Bx	Nx/Yx	Vx/Tx	Gx
250	325	375	375	325	400	550

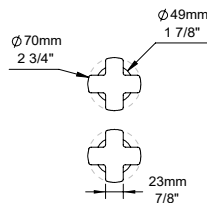

Handle kit for thermostatic pressure balanced shower valve with diverter

- A- Handle kit required to complete product
B80-952X-00-xx and B80-953X-00-xx
- B- Comes in pair
- C- Made of brass parts

M80-9520-110-xx

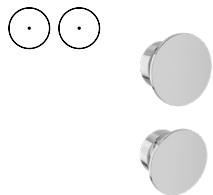

M80-9520-120-xx

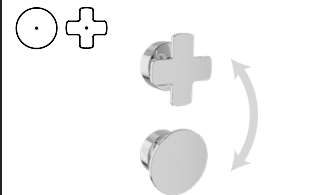

M80-9520-130-xx

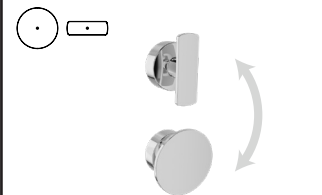

M80-9520-220-xx

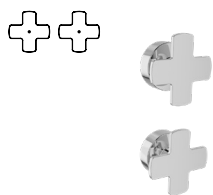

M80-9520-230-xx

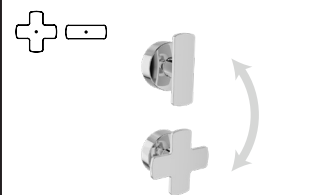

M80-9520-330-xx

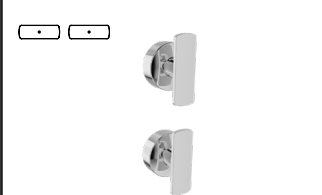

ASSEMBLED PRODUCT IMAGES

B80-9521-00-xx +
M80-9520-110-xx



B80-9521-00-xx +
M80-9520-120-xx

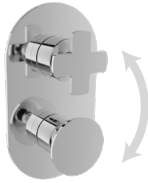

B80-9521-00-xx +
M80-9520-130-xx

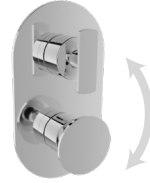

B80-9521-00-xx +
M80-9520-220-xx

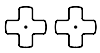

B80-9521-00-xx +
M80-9520-230-xx

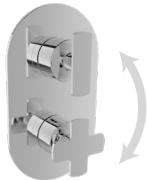

B80-9521-00-xx +
M80-9520-330-xx



Finishes:

CC = chrome, KK = matte black, LL = satin brass, BB = white, NN = brushed nickel, YY = polished nickel, TT = venetian bronze, VV = satin copper, GG = gold 253

AIR B80

B80-9522-00-xx

VALVE WITHOUT HANDLE

Available Q3 2023

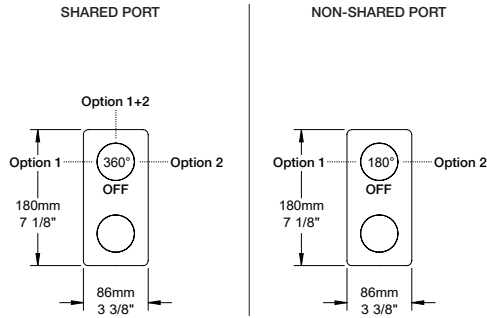

CC	KK	LL	BB	NN/YY	VV/TT	GG
1050	1160	1233	1233	1160	1269	1488

Thermostatic pressure balanced shower valve with 2-way diverter without handle (shared port)

- A- 1 outlet: 7.9 gpm - 60 psi, 2 outlets: 3.7 gpm - 60 psi
- B- Up to 2 accessories can be used at the same time
- C- Thin brass plate
- D- Reversible check / non-return valves in case of water supply inversion
- E- CAR-2661-00 (temperature), CAR-3003-36 (diverter)
- F- Rough valve RVA-9521-00-B included
- G- Large depth adjustment range

Ecological options CEC

Codes	Features
B80-9522-00-xx-NS	Non-shared port
T80-9522-00-xx + RVA-9521-00-NS-B	1 accessory works at a time
T80-9522-00-xx + RVA-9521-PO-NS-B	CAR-3003-36-NS (diverter)

TRIM ONLY

T80-9522-00-xx

CC	KK	LL	BB	NN/YY	VV/TT	GG
365	475	548	548	475	584	803

ROUGH VALVES Please order **one** of the following rough valves to complete the trim:

RVA-9521-00-B

2-way TP rough - 1/2" male NPT or welded copper connections

685

RVA-9521-PO-B

2-way TP rough - PEX connections

685

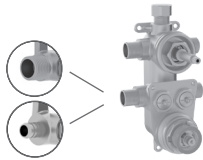

HANDLE OPTIONS Please order **one** of the following handle kits to complete the product (see below for details):

M80-9520-110-xx



M80-9520-120-xx



M80-9520-130-xx



M80-9520-220-xx



M80-9520-230-xx



M80-9520-330-xx



M80-9520-XX0-xx

HANDLE KIT

Cx	Kx	Lx	Bx	Nx/Yx	Vx/Tx	Gx
250	325	375	375	325	400	550

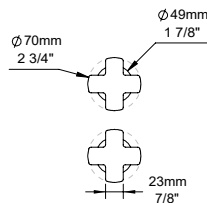

Handle kit for thermostatic pressure balanced shower valve with diverter

- A- Handle kit required to complete product
- B- Comes in pair
- C- Made of brass parts

M80-9520-110-xx

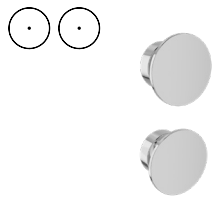

M80-9520-120-xx

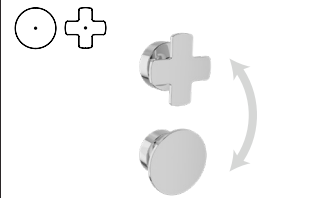

M80-9520-130-xx

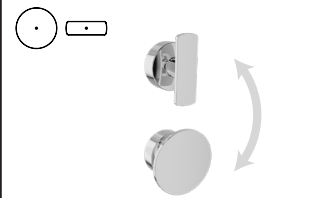

M80-9520-220-xx

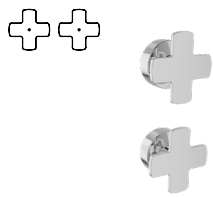

M80-9520-230-xx

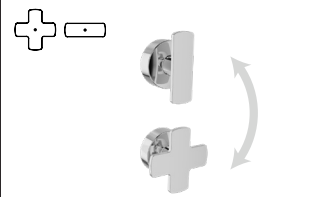

M80-9520-330-xx

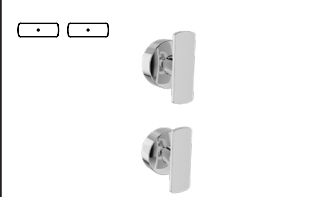

ASSEMBLED PRODUCT IMAGES

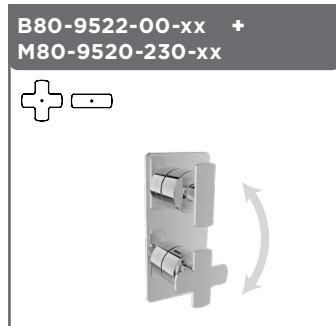
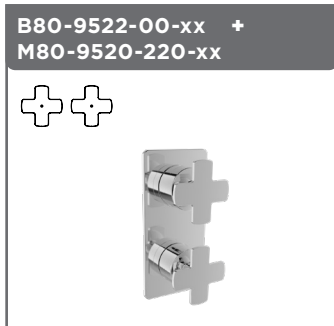
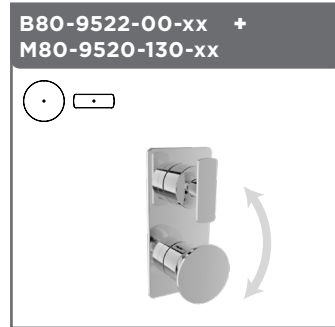
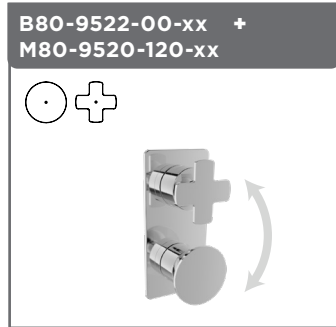
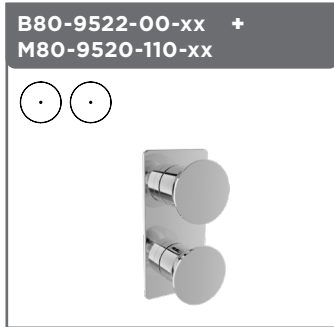

Finishes:

CC = chrome, KK = matte black, LL = satin brass, BB = white, NN = brushed nickel, YY = polished nickel, TT = venetian bronze, VV = satin copper, GG = gold 255

AIR B80

B80-9531-00-xx

VALVE WITHOUT HANDLE

Available Q3 2023

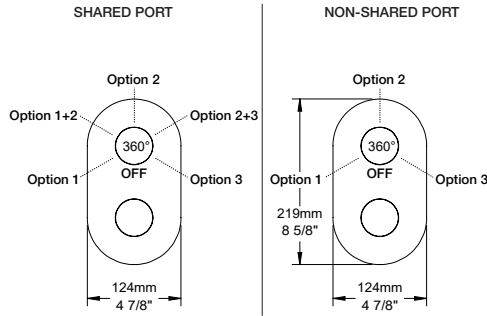

CC	KK	LL	BB	NN/YY	VV/TT	GG
1160	1270	1343	1343	1270	1379	1598

Thermostatic pressure balanced shower valve with 3-way diverter without handle (shared port)

- A- 1 outlet: 7.9 gpm - 60 psi, 2 outlets: 3.7 gpm - 60 psi
- B- Up to 2 accessories can be used at the same time
- C- Thin brass plate
- D- Reversible check / non-return valves in case of water supply inversion
- E- CAR-2661-00 (temperature), CAR-9531-03 (diverter)
- F- Rough valve RVA-9531-00-B included
- G- Large depth adjustment range

Ecological options CEC

Codes	Features
B80-9531-00-xx-NS	Non-shared port
T80-9531-00-xx + RVA-9531-00-NS-B	1 accessory works at a time
T80-9531-00-xx + RVA-9531-PO-NS-B	CAR-9531-03-NS (diverter)

TRIM ONLY

T80-9531-00-xx

CC	KK	LL	BB	NN/YY	VV/TT	GG
365	475	548	548	475	584	803

ROUGH VALVES Please order **one** of the following rough valves to complete the trim:

RVA-9531-00-B

3-way TP rough - 1/2" male NPT or welded copper connections

795

RVA-9531-PO-B

3-way TP rough - PEX connections

795

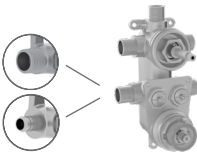

HANDLE OPTIONS Please order **one** of the following handle kits to complete the product (see below for details):

M80-9520-110-xx



M80-9520-120-xx



M80-9520-130-xx



M80-9520-220-xx



M80-9520-230-xx



M80-9520-330-xx



M80-9520-XX0-xx

HANDLE KIT

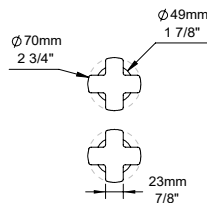

Cx	Kx	Lx	Bx	Nx/Yx	Vx/Tx	Gx
250	325	375	375	325	400	550

Handle kit for thermostatic pressure balanced shower valve with diverter

- A- Handle kit required to complete product
B80-952X-00-xx and B80-953X-00-xx
- B- Comes in pair
- C- Made of brass parts

M80-9520-110-xx

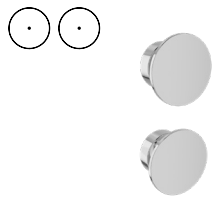

M80-9520-120-xx

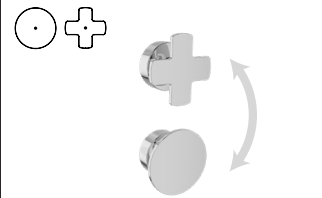

M80-9520-130-xx

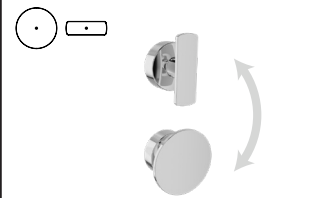

M80-9520-220-xx

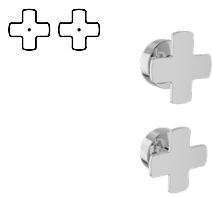

M80-9520-230-xx

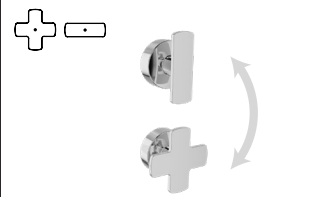

M80-9520-330-xx

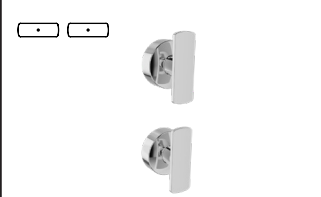

ASSEMBLED PRODUCT IMAGES

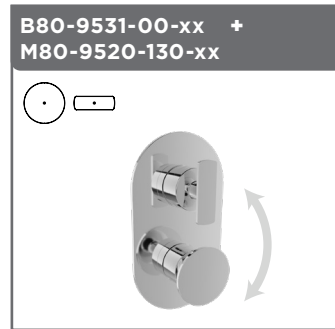
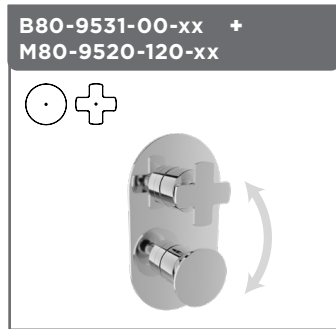

Finishes:

CC = chrome, KK = matte black, LL = satin brass, BB = white, NN = brushed nickel, YY = polished nickel, TT = venetian bronze, VV = satin copper, GG = gold 257

AIR B80

B80-9532-00-xx

VALVE WITHOUT HANDLE

CC	KK	LL	BB	NN/YY	VV/TT	GG
1160	1270	1343	1343	1270	1379	1598

Available Q3 2023

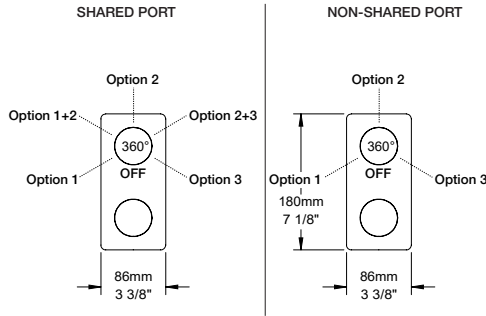

Thermostatic pressure balanced shower valve with 3-way diverter without handle (shared port)

- A- 1 outlet: 7.9 gpm - 60 psi, 2 outlets: 3.7 gpm - 60 psi
- B- Up to 2 accessories can be used at the same time
- C- Thin brass plate
- D- Reversible check / non-return valves in case of water supply inversion
- E- CAR-2661-00 (temperature), CAR-9531-03 (diverter)
- F- Rough valve RVA-9531-00-B included
- G- Large depth adjustment range

Ecological options CEC

Codes	Features
B80-9532-00-xx-NS	Non-shared port
T80-9532-00-xx + RVA-9531-00-NS-B	1 accessory works at a time
T80-9532-00-xx + RVA-9531-PO-NS-B	CAR-9531-03-NS (diverter)

TRIM ONLY

T80-9532-00-xx

CC	KK	LL	BB	NN/YY	VV/TT	GG
365	475	548	548	475	584	803

HANDLE OPTIONS Please order **one** of the following handle kits to complete the product (see below for details):

RVA-9531-00-B

3-way TP rough - 1/2" male NPT or welded copper connections

795

RVA-9531-PO-B

3-way TP rough - PEX connections

795

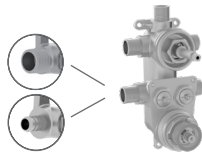

OPTIONS DE MANETTES Commandez svp **un** des ensembles de manettes suivants pour compléter le produit (voir ci-dessous pour plus de détails) :

M80-9520-110-xx



M80-9520-120-xx



M80-9520-130-xx



M80-9520-220-xx



M80-9520-230-xx



M80-9520-330-xx



M80-9520-XX0-xx

HANDLE KIT

Cx	Kx	Lx	Bx	Nx/Yx	Vx/Tx	Gx
250	325	375	375	325	400	550

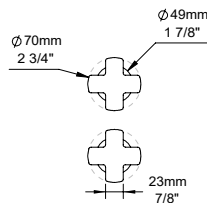

Handle kit for thermostatic pressure balanced shower valve with diverter

- A- Handle kit required to complete product
B80-952X-00-xx and B80-953X-00-xx
- B- Comes in pair
- C- Made of brass parts

M80-9520-110-xx

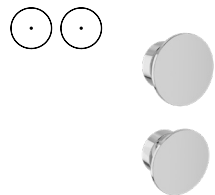

M80-9520-120-xx

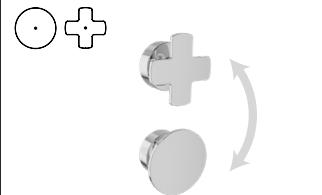

M80-9520-130-xx

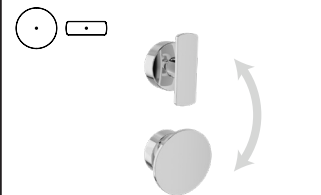

M80-9520-220-xx

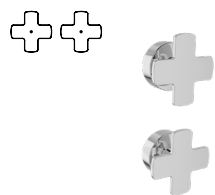

M80-9520-230-xx

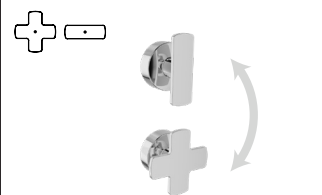

M80-9520-330-xx

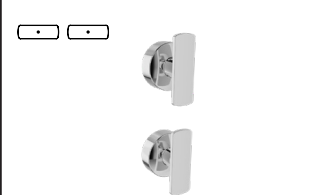

ASSEMBLED PRODUCT IMAGES

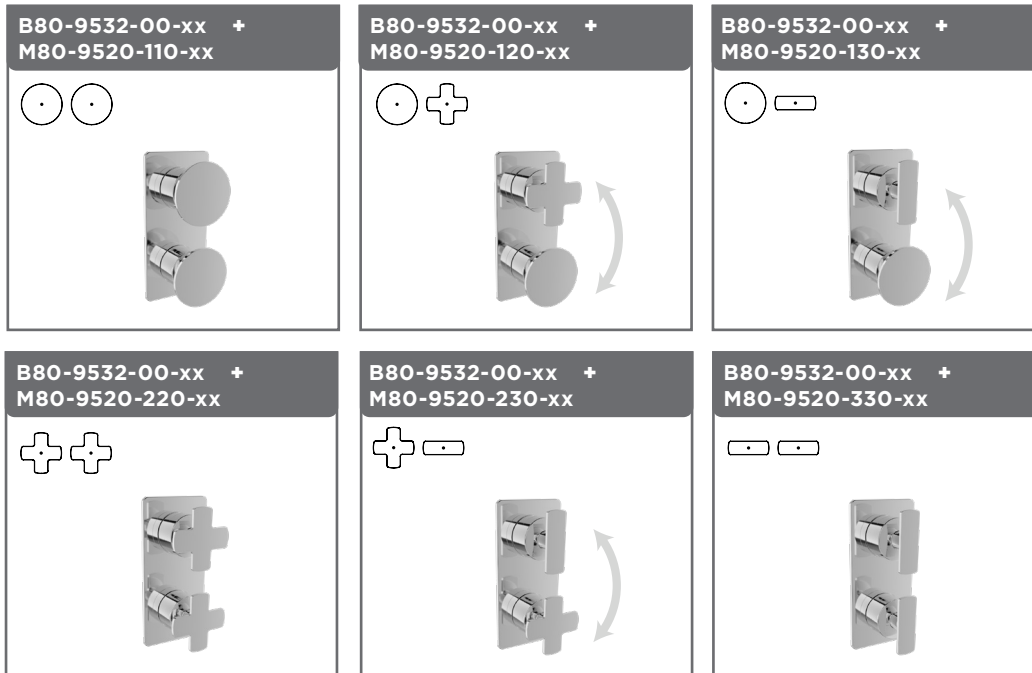

Finishes:

CC = chrome, KK = matte black, LL = satin brass, BB = white, NN = brushed nickel, YY = polished nickel, TT = venetian bronze, VV = satin copper, GG = gold 259

AIR B80

B80-9560-02-xx

VALVE WITHOUT HANDLE

Available Q3 2023

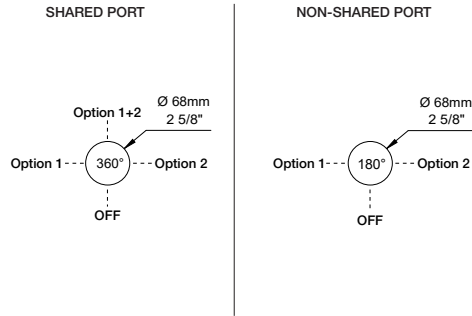

CC	KK	LL	BB	NN/YY	VV/TT	GG
399	429	449	449	429	459	519

2-port diverter with stop without handle (shared port)

- A- 1 outlet: 10.5 gpm - 60 psi, 2 outlets: 4 gpm - 60 psi
- B- Can replace 2 volume control valves
- C- Up to 2 accessories can be used at the same time
- D- CAR-9525-02
- E- Rough RVA-9562-00-B included
- F- Extra long cartridge for maximum adjustment

Ecological options CEC

Codes	Features
B80-9560-02-xx-NS	Non-shared port
T80-9560-02-xx + RVA-9562-00-NS-B	1 accessory works at a time CAR-9525-02-NS (diverter)

TRIM ONLY

T80-9560-02-xx

CC	KK	LL	BB	NN/YY	VV/TT	GG
100	130	150	150	130	160	220

ROUGH VALVE Please order the following rough valve to complete the trim:

RVA-9562-00-B

2-port diverter rough - 1/2" male NPT or welded copper connections

299

HANDLE OPTIONS Please order **one** of the following handle kits to complete the product (see below for details):

M80-9500-10-xx	Circular handle		M80-9500-30-xx	Symmetrical lever handle	
M80-9500-20-xx	Cross handle		M80-9500-40-xx	Asymmetrical lever handle	

M80-9500-X0-xx

HANDLE KIT

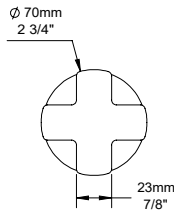

Cx	Kx	Lx	Bx	Nx/Yx	Vx/Tx	Gx
125	163	188	188	163	200	275

Handle kit for diverter with stop

- A- Handle kit required to complete product B80-9560-0X-xx and B80-9649-00-xx
- B- Made of brass parts

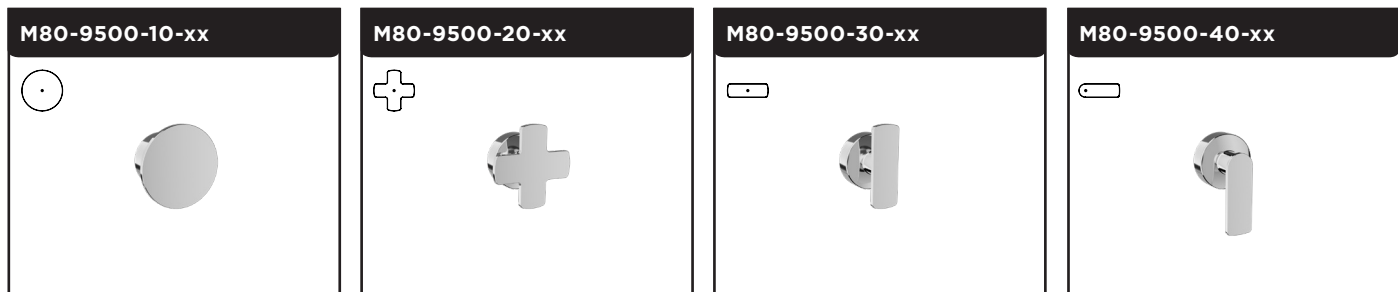

ASSEMBLED PRODUCT IMAGES

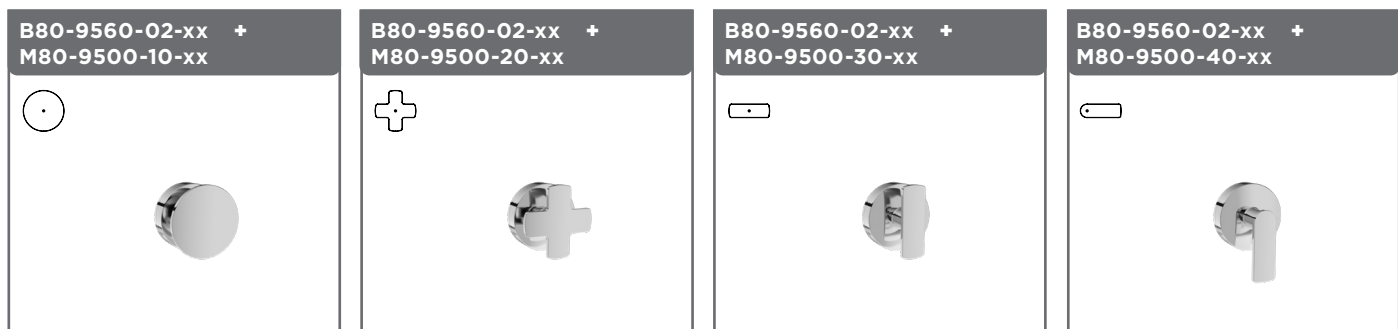

Actual products may differ from pictures. Actual products measures may differ from the measures shown. All USD prices are subject to change without notice. Effective as of August 2023.

B80-9560-03-xx

VALVE WITHOUT HANDLE

Available Q3 2023



SHARED PORT

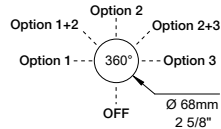

NON-SHARED PORT

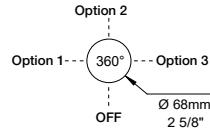

CC	KK	LL	BB	NN/YY	VV/TT	GG
481	511	531	531	511	541	601

3-port diverter with stop without handle (shared port)

- A- 1 outlet: 9.7 gpm - 60 psi, 2 outlets: 5.2 gpm - 60 psi
- B- Can replace 2 or 3 volume control valves
- C- Up to 2 accessories can be used at the same time
- D- CAR-9530-03
- E- Rough RVA-9563-00-B included
- F- Extra long cartridge for maximum adjustment

Ecological options CEC

Codes	Features
B80-9560-03-xx-NS	Non-shared port
T80-9560-03-xx + RVA-9563-00-NS-B	1 accessory works at a time CAR-9530-03-NS (diverter)

TRIM ONLY

T80-9560-03-xx

CC	KK	LL	BB	NN/YY	VV/TT	GG
100	130	150	150	130	160	220

ROUGH VALVE Please order the following rough valve to complete the trim:

RVA-9563-00-B

3-port diverter rough - inlet: 3/4" F NPT - outlets: 1/2" F NPT

381

HANDLE OPTIONS Please order **one** of the following handle kits to complete the product (see below for details):

M80-9500-10-xx

Circular handle



M80-9500-30-xx

Symmetrical lever handle



M80-9500-20-xx

Cross handle



M80-9500-40-xx

Asymmetrical lever handle



M80-9500-X0-xx

HANDLE KIT

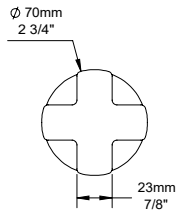

Cx	Kx	Lx	Bx	Nx/Yx	Vx/Tx	Gx
125	163	188	188	163	200	275

Handle kit for diverter with stop

- A- Handle kit required to complete product
B80-9560-0X-xx and B80-9649-00-xx
- B- Made of brass parts

M80-9500-10-xx

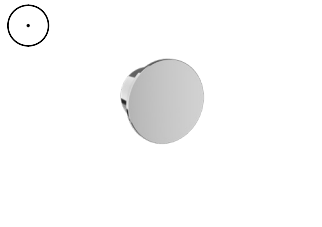

M80-9500-20-xx

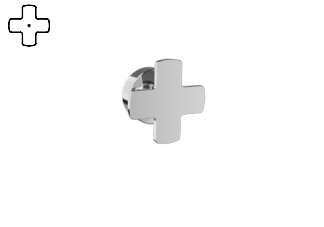

M80-9500-30-xx



M80-9500-40-xx



ASSEMBLED PRODUCT IMAGES

B80-9560-03-xx + M80-9500-10-xx

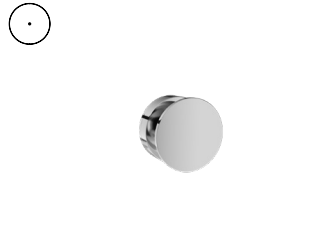

B80-9560-03-xx + M80-9500-20-xx



B80-9560-03-xx + M80-9500-30-xx

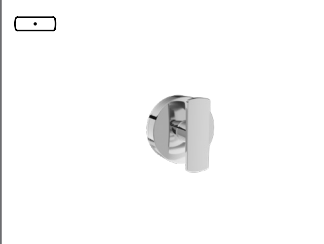

B80-9560-03-xx + M80-9500-40-xx



Finishes:

CC = chrome, KK = matte black, LL = satin brass, BB = white, NN = brushed nickel, YY = polished nickel, TT = venetian bronze, VV = satin copper, GG = gold 261

AIR B80

B80-9649-00-xx

VALVE WITHOUT HANDLE

CC	KK	LL	BB	NN/YY	VV/TT	GG
335	365	385	385	365	395	455

Available Q3 2023

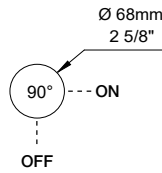

3/4" volume control valve without handle

- A- 11.1 gpm - 60 psi
- B- Volume control valve
- C- Offers higher flow
- D- CAR-2719-34
- E- Rough valve RVA-2719-34-B included
- F- Extra long cartridge for maximum adjustment

TRIM ONLY



T80-9649-00-xx

CC	KK	LL	BB	NN/YY	VV/TT	GG
100	130	150	150	130	160	220

ROUGH VALVE Please order the following rough valve to complete the trim:

RVA-2719-34-B

Volume control valve rough - 3/4" female NPT connections

235

HANDLE OPTIONS Please order **one** of the following handle kits to complete the product (see below for details):

M80-9500-10-xx	Circular handle		M80-9500-30-xx	Symmetrical lever handle	
M80-9500-20-xx	Cross handle		M80-9500-40-xx	Asymmetrical lever handle	

M80-9500-X0-xx

HANDLE KIT

Cx	Kx	Lx	Bx	Nx/Yx	Vx/Tx	Gx
125	163	188	188	163	200	275

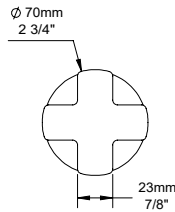

Handle kit for 3/4" volume control valve

- A- Handle kit required to complete product B80-9560-0X-xx and B80-9649-00-xx
- B- Made of brass parts

M80-9500-10-xx	M80-9500-20-xx	M80-9500-30-xx	M80-9500-40-xx

ASSEMBLED PRODUCT IMAGES

















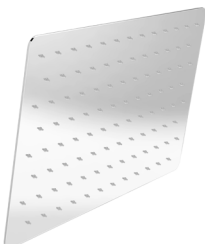

B80-9649-00-xx + M80-9500-10-xx	B80-9649-00-xx + M80-9500-20-xx	B80-9649-00-xx + M80-9500-30-xx	B80-9649-00-xx + M80-9500-40-xx

Actual products may differ from pictures. Actual products measures may differ from the measures shown. All USD prices are subject to change without notice. Effective as of August 2023.

AIR B80

SELECTION OF SHOWER COMPONENTS

For more shower components and for ecological options, please refer to the shower components section (see p. 347-382).

TET-0810-01-xx 8" round shower head  <table border="1"> <thead> <tr> <th>CC</th> <th>KK</th> <th>LL</th> <th>BB</th> </tr> </thead> <tbody> <tr> <td>445</td> <td>579</td> <td>668</td> <td>668</td> </tr> </tbody> </table>	CC	KK	LL	BB	445	579	668	668	TET-1010-01-xx 10" round shower head  <table border="1"> <thead> <tr> <th>CC</th> <th>KK</th> <th>LL</th> <th>BB</th> </tr> </thead> <tbody> <tr> <td>575</td> <td>748</td> <td>863</td> <td>863</td> </tr> </tbody> </table>	CC	KK	LL	BB	575	748	863	863	TET-1213-01-xx 12" round shower head  <table border="1"> <thead> <tr> <th>CC</th> </tr> </thead> <tbody> <tr> <td>572</td> </tr> </tbody> </table>	CC	572	TET-1208-01-xx 12" x 8" rectangular shower head  <table border="1"> <thead> <tr> <th>CC</th> <th>KK</th> </tr> </thead> <tbody> <tr> <td>462</td> <td>601</td> </tr> </tbody> </table>	CC	KK	462	601	BRA-1612-66-xx 16" shower arm  <table border="1"> <thead> <tr> <th>CC</th> <th>KK</th> <th>LL</th> <th>BB</th> </tr> </thead> <tbody> <tr> <td>179</td> <td>233</td> <td>269</td> <td>269</td> </tr> </tbody> </table>	CC	KK	LL	BB	179	233	269	269										
CC	KK	LL	BB																																									
445	579	668	668																																									
CC	KK	LL	BB																																									
575	748	863	863																																									
CC																																												
572																																												
CC	KK																																											
462	601																																											
CC	KK	LL	BB																																									
179	233	269	269																																									
TET-0813-01-xx 8" round shower head  <table border="1"> <thead> <tr> <th>CC</th> </tr> </thead> <tbody> <tr> <td>310</td> </tr> </tbody> </table>	CC	310	TET-1013-01-xx 10" round shower head  <table border="1"> <thead> <tr> <th>CC</th> <th>KK</th> </tr> </thead> <tbody> <tr> <td>416</td> <td>541</td> </tr> </tbody> </table>	CC	KK	416	541	TET-1613-01-xx 16" round shower head  <table border="1"> <thead> <tr> <th>CC</th> </tr> </thead> <tbody> <tr> <td>809</td> </tr> </tbody> </table>	CC	809	TET-2012-01-xx 20" x 12" rectangular shower head  <table border="1"> <thead> <tr> <th>CC</th> </tr> </thead> <tbody> <tr> <td>965</td> </tr> </tbody> </table>	CC	965	BRA-1815-02-xx 18" shower arm  <table border="1"> <thead> <tr> <th>CC</th> <th>KK</th> <th>LL</th> <th>BB</th> </tr> </thead> <tbody> <tr> <td>325</td> <td>423</td> <td>488</td> <td>488</td> </tr> </tbody> </table>	CC	KK	LL	BB	325	423	488	488																						
CC																																												
310																																												
CC	KK																																											
416	541																																											
CC																																												
809																																												
CC																																												
965																																												
CC	KK	LL	BB																																									
325	423	488	488																																									
DGL-2584-53-xx 3-spray sliding shower bar  <table border="1"> <thead> <tr> <th>CC</th> <th>KK</th> <th>LL</th> <th>BB</th> </tr> </thead> <tbody> <tr> <td>604</td> <td>785</td> <td>906</td> <td>906</td> </tr> </tbody> </table>	CC	KK	LL	BB	604	785	906	906	DGL-2580-53-xx 3-spray sliding shower bar  <table border="1"> <thead> <tr> <th>CC</th> <th>KK</th> <th>LL</th> <th>BB</th> </tr> </thead> <tbody> <tr> <td>594</td> <td>772</td> <td>891</td> <td>891</td> </tr> </tbody> </table>	CC	KK	LL	BB	594	772	891	891	DSP-2574-19-xx Hand shower on wall-mounted supply elbow  <table border="1"> <thead> <tr> <th>CC</th> <th>KK</th> <th>LL</th> <th>BB</th> </tr> </thead> <tbody> <tr> <td>466</td> <td>606</td> <td>699</td> <td>699</td> </tr> </tbody> </table>	CC	KK	LL	BB	466	606	699	699	DSP-2604-19-xx Hand shower on wall-mounted supply elbow  <table border="1"> <thead> <tr> <th>CC</th> <th>KK</th> <th>LL</th> <th>BB</th> </tr> </thead> <tbody> <tr> <td>492</td> <td>639</td> <td>738</td> <td>738</td> </tr> </tbody> </table>	CC	KK	LL	BB	492	639	738	738	RAC-9001-16-xx 1/2" F wall-mount supply elbow  <table border="1"> <thead> <tr> <th>CC</th> <th>KK</th> <th>LL</th> <th>BB</th> </tr> </thead> <tbody> <tr> <td>124</td> <td>161</td> <td>186</td> <td>186</td> </tr> </tbody> </table>	CC	KK	LL	BB	124	161	186	186
CC	KK	LL	BB																																									
604	785	906	906																																									
CC	KK	LL	BB																																									
594	772	891	891																																									
CC	KK	LL	BB																																									
466	606	699	699																																									
CC	KK	LL	BB																																									
492	639	738	738																																									
CC	KK	LL	BB																																									
124	161	186	186																																									
BEC-0520-37-xx Round modern tub spout without diverter  <table border="1"> <thead> <tr> <th>CC</th> <th>KK</th> <th>LL</th> <th>BB</th> </tr> </thead> <tbody> <tr> <td>219</td> <td>285</td> <td>329</td> <td>329</td> </tr> </tbody> </table>	CC	KK	LL	BB	219	285	329	329	BEC-0520-73-xx 7" round tub spout without diverter  <table border="1"> <thead> <tr> <th>CC</th> <th>KK</th> <th>LL</th> <th>BB</th> </tr> </thead> <tbody> <tr> <td>168</td> <td>218</td> <td>252</td> <td>252</td> </tr> </tbody> </table>	CC	KK	LL	BB	168	218	252	252	BEC-0520-74-xx 7" round tub spout with diverter  <table border="1"> <thead> <tr> <th>CC</th> <th>KK</th> <th>LL</th> <th>BB</th> </tr> </thead> <tbody> <tr> <td>198</td> <td>257</td> <td>297</td> <td>297</td> </tr> </tbody> </table>	CC	KK	LL	BB	198	257	297	297	BOD-5002-01-xx Cylindrical lateral body jet  <table border="1"> <thead> <tr> <th>CC</th> <th>KK</th> <th>LL</th> <th>BB</th> </tr> </thead> <tbody> <tr> <td>199</td> <td>259</td> <td>299</td> <td>299</td> </tr> </tbody> </table>	CC	KK	LL	BB	199	259	299	299	BOD-5007-01-xx Round built-in lateral body jet  <table border="1"> <thead> <tr> <th>CC</th> <th>KK</th> <th>LL</th> <th>BB</th> </tr> </thead> <tbody> <tr> <td>325</td> <td>423</td> <td>488</td> <td>488</td> </tr> </tbody> </table>	CC	KK	LL	BB	325	423	488	488
CC	KK	LL	BB																																									
219	285	329	329																																									
CC	KK	LL	BB																																									
168	218	252	252																																									
CC	KK	LL	BB																																									
198	257	297	297																																									
CC	KK	LL	BB																																									
199	259	299	299																																									
CC	KK	LL	BB																																									
325	423	488	488																																									

Actual products may differ from pictures. Actual products measures may differ from the measures shown. All USD prices are subject to change without notice. Effective as of August 2023.

COMPLETE SHOWER KITS

PRO-1101-53-xx

Available
Q3 2023



Complete thermostatic shower kit on column

CC	KK	LL	BB	NN/YY	VV/TT	GG
1895	2464	2843	2843	2464	3032	4169

Features

- A- Max: 2 gpm - 80 psi (per accessory)
- B- 3-spray push-button hand shower
- C- 2 accessories can work together
- D- Temperature handle on the hot water inlet side, allowing the surface temperature to never exceed the shower water temperature
- E- Shower head arm adjustable up to 20" in height
- F- Easy to move metal slider with built-in hook
- G- Thermostatic cartridge: CAR-2661-00
- H- Diverter cartridge: CAR-3003-36

Ecological options

Code	Features are the same, except:
PRO-1101-53-xx-NS	A- Max: 1.75 gpm - 80 psi (per accessory) C- 1 accessory works at a time H- Diverter cartridge: CAR-3003-36-NS

PRO-1102-53-xx

Available
Q3 2023



Complete thermostatic shower kit on column

CC	KK	LL	BB	NN/YY	VV/TT	GG
1995	2594	2993	2993	2594	3192	4389

Features

- A- Max: 2 gpm - 80 psi (per accessory)
- B- 3-spray push-button hand shower
- C- 2 accessories can work together
- D- Temperature handle on the hot water inlet side, allowing the surface temperature to never exceed the shower water temperature
- E- Shower head arm adjustable up to 20" in height
- F- Easy to move metal slider with built-in hook
- G- Thermostatic cartridge: CAR-2661-00
- H- Diverter cartridge: CAR-3003-36

Ecological options

Code	Features are the same, except:
PRO-1102-53-xx-NS	A- Max: 1.75 gpm - 80 psi (per accessory) C- 1 accessory works at a time H- Diverter cartridge: CAR-3003-36-NS

Finishes:

CC = chrome, KK = matte black, LL = satin brass, BB = white, NN = brushed nickel, YY = polished nickel, TT = venetian bronze, VV = satin copper, GG = gold 265

AIR B80

PRO-2101-80-xx

Complete pressure balanced shower kit without handle

CC	KK	LL	BB	NN/YY	VV/TT	GG
1070	1391	1605	1605	1391	1712	2354

Available Q3 2023



Features

- A- Max: 2 gpm - 80 psi
- B- 3-spray hand shower

Includes

- B80-9101-00-CC** Type P valve without handle
- DGL-2580-53-xx** 3-spray sliding shower bar
- RAC-9001-16-xx** Wall-mount supply elbow

Ecological options CEC

Codes

PRO-2101-80-xx-175
TRO-2101-80-xx-175 + RVA-9020-00-B

Features are the same, except:

A- Max: 1.75 gpm - 80 psi (hand shower)

TRIM ONLY

TRO-2101-80-xx

CC	KK	LL	BB	NN/YY	VV/TT	GG
760	1081	1295	1295	1081	1402	2044

ROUGH VALVES Please order **one** of the following rough valves to complete the trim:

RVA-9020-00-B

Type P rough - 1/2" male NPT or welded copper connections

310

RVA-9020-P0-B

Type P rough - PEX connections

310

HANDLE OPTIONS Please order **one** of the following handle kits to complete the product (see p. 243 for details):

M80-9100-10-xx

Circular handle



M80-9100-30-xx

Symmetrical lever handle



M80-9100-20-xx

Cross handle



M80-9100-40-xx

Asymmetrical lever handle



ASSEMBLED PRODUCT IMAGES

PRO-2101-80-xx + M80-9100-10-xx



PRO-2101-80-xx + M80-9100-20-xx



PRO-2101-80-xx + M80-9100-30-xx



PRO-2101-80-xx + M80-9100-40-xx



Actual products may differ from pictures. Actual products measures may differ from the measures shown. All USD prices are subject to change without notice. Effective as of August 2023.

AIR B80

PRO-2102-80-xx

Available Q3 2023



Complete pressure balanced shower kit without handle

CC	KK	LL	BB	NN/YY	VV/TT	GG
1070	1391	1605	1605	1391	1712	2354

Features

A- Max: 2 gpm - 80 psi
B- 3-spray hand shower

Includes

B80-9102-00-CC Type P valve without handle
DGL-2584-53-xx 3-spray sliding shower bar
RAC-9001-16-xx Wall-mount supply elbow

Ecological options CEC

Codes

PRO-2102-80-xx-175
TRO-2102-80-xx-175 + RVA-9020-00-B

Features are the same, except:

A- Max: 1.75 gpm - 80 psi (hand shower)

TRIM ONLY

TRO-2102-80-xx

CC	KK	LL	BB	NN/YY	VV/TT	GG
760	1081	1295	1295	1081	1402	2044

ROUGH VALVES Please order **one** of the following rough valves to complete the trim:

RVA-9020-00-B

Type P rough - 1/2" male NPT or welded copper connections

310

RVA-9020-P0-B

Type P rough - PEX connections

310

HANDLE OPTIONS Please order **one** of the following handle kits to complete the product (see p. 244 for details):

M80-9100-10-xx

Circular handle



M80-9100-30-xx

Symmetrical lever handle



M80-9100-20-xx

Cross handle



M80-9100-40-xx

Asymmetrical lever handle



ASSEMBLED PRODUCT IMAGES

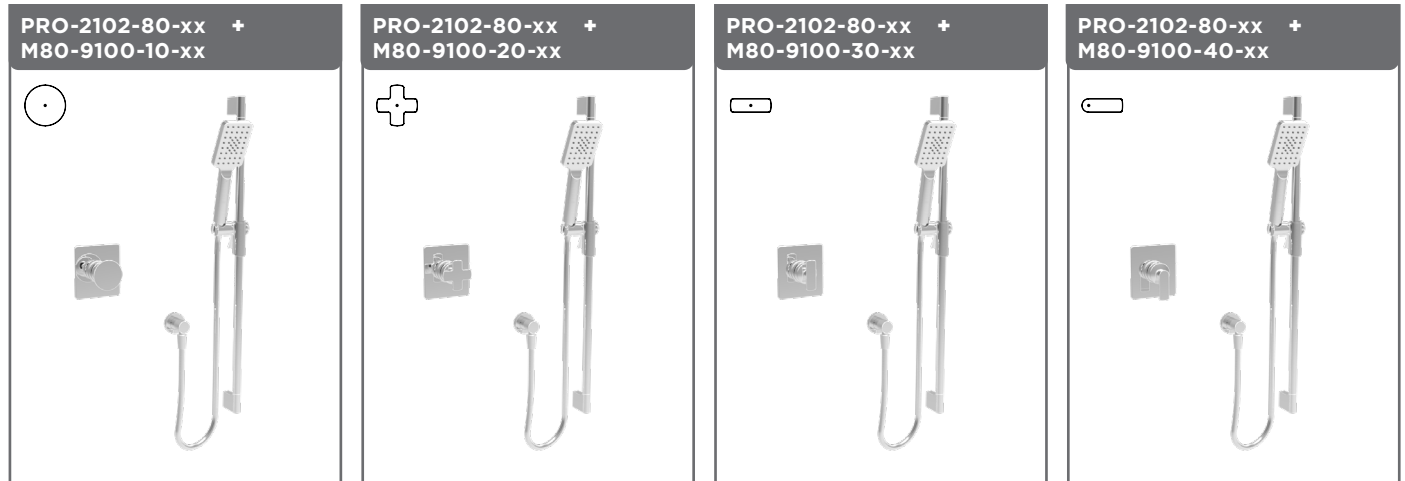

Finishes:

CC = chrome, KK = matte black, LL = satin brass, BB = white, NN = brushed nickel, YY = polished nickel, TT = venetian bronze, VV = satin copper, GG = gold 267

AIR B80

PRO-2201-80-xx

Complete pressure balanced shower kit without handle

CC	KK	LL	BB	NN/YY	VV/TT	GG
1264	1643	1896	1896	1643	2022	2781

Available Q3 2023



Features

A- Max: 2 gpm - 80 psi
B- 3-spray hand shower

Includes

B80-9101-00-CC Type P valve without handle
BEC-0520-74-CC 7" round tub spout with diverter
DGL-2580-53-xx 3-spray sliding shower bar
RAC-9001-16-xx Wall-mount supply elbow

Ecological options CEC

Codes

PRO-2201-80-xx-175
TRO-2201-80-xx-175 + RVA-9020-00-B

Features are the same, except:

A- Max: 1.75 gpm - 80 psi (hand shower)

TRIM ONLY

TRO-2201-80-xx

CC	KK	LL	BB	NN/YY	VV/TT	GG
954	1333	1586	1586	1333	1712	2471

ROUGH VALVES Please order **one** of the following rough valves to complete the trim:

RVA-9020-00-B

Type P rough - 1/2" male NPT or welded copper connections

310

RVA-9020-P0-B

Type P rough - PEX connections

310

HANDLE OPTIONS Please order **one** of the following handle kits to complete the product (see p. 243 for details):

M80-9100-10-xx

Circular handle



M80-9100-30-xx

Symmetrical lever handle



M80-9100-20-xx

Cross handle



M80-9100-40-xx

Asymmetrical lever handle



ASSEMBLED PRODUCT IMAGES

PRO-2201-80-xx + M80-9100-10-xx



PRO-2201-80-xx + M80-9100-20-xx

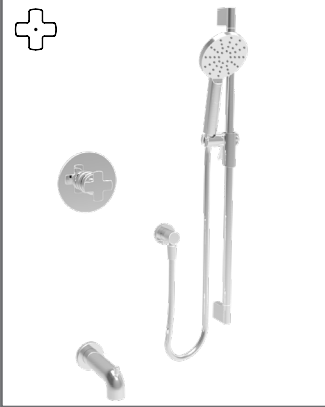

PRO-2201-80-xx + M80-9100-30-xx



PRO-2201-80-xx + M80-9100-40-xx



Actual products may differ from pictures. Actual products measures may differ from the measures shown. All USD prices are subject to change without notice. Effective as of August 2023.

AIR B80

PRO-2202-80-xx

Complete pressure balanced shower kit without handle

CC	KK	LL	BB	NN/YY	VV/TT	GG
1264	1643	1896	1896	1643	2022	2781

Available Q3 2023



Features

- A- Max: 2 gpm - 80 psi
- B- 3-spray hand shower

Includes

- B80-9102-00-CC** Type P valve without handle
- BEC-0520-74-CC** 7" round tub spout with diverter
- DGL-2584-53-xx** 3-spray sliding shower bar
- RAC-9001-16-xx** Wall-mount supply elbow

Ecological options CEC

Codes

PRO-2202-80-xx-175
TRO-2202-80-xx-175 + RVA-9020-00-B

Features are the same, except:

A- Max: 1.75 gpm - 80 psi (hand shower)

TRIM ONLY

TRO-2202-80-xx

CC	KK	LL	BB	NN/YY	VV/TT	GG
954	1333	1586	1586	1333	1712	2471

ROUGH VALVES Please order **one** of the following rough valves to complete the trim:

RVA-9020-00-B

Type P rough - 1/2" male NPT or welded copper connections

310

RVA-9020-P0-B

Type P rough - PEX connections

310

HANDLE OPTIONS Please order **one** of the following handle kits to complete the product (see p. 244 for details):

M80-9100-10-xx

Circular handle



M80-9100-30-xx

Symmetrical lever handle



M80-9100-20-xx

Cross handle



M80-9100-40-xx

Asymmetrical lever handle



ASSEMBLED PRODUCT IMAGES

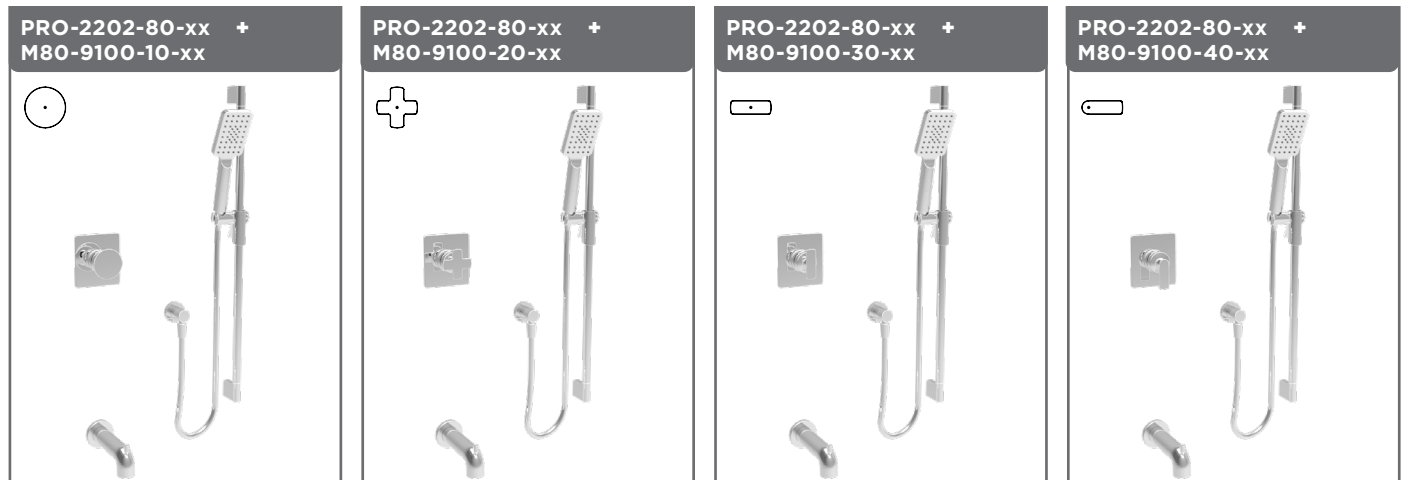

Finishes:

CC = chrome, KK = matte black, LL = satin brass, BB = white, NN = brushed nickel, YY = polished nickel, TT = venetian bronze, VV = satin copper, GG = gold 269

AIR B80

PRO-2801-80-xx PRR-2801-80-xx*

Available Q3 2023



Complete pressure balanced shower kit without handle

CC	KK	LL	BB	NN/YY	VV/TT	GG
1725	2243	2588	2588	2243	2760	3795

Features

- A- 2 accessories kit
- B- Max: 2 gpm - 80 psi (per accessory)
- C- 3-spray hand shower
- D- 2 accessories can work together

Includes

- B80-9181-00-xx** Type P valve with 2-way diverter without handle
- TET-0810-01-xx** 8" round shower head
- BRA-1612-66-xx** 16" shower arm
- DGL-2580-53-xx** 3-spray sliding shower bar
- RAC-9001-16-xx** Wall-mount supply elbow

Ecological options CEC

Codes

- PRO-2801-80-xx-NS
- TRO-2801-80-xx-NS + RVA-9181-00-NS-B

Features are the same, except:

- B- Max: 1.75 gpm - 80 psi (per accessory)
- D- 1 accessory works at a time

TRIM ONLY

TRO-2801-80-xx TRR-2801-80-xx*

CC	KK	LL	BB	NN/YY	VV/TT	GG
1251	1769	2114	2114	1769	2286	3321

ROUGH VALVES Please order **one** of the following rough valves to complete the trim:

RVA-9181-00-B

2-way type P rough - 1/2" male NPT or welded copper connections

474

RVA-9181-PO-B

2-way type P rough - PEX connections

474

HANDLE OPTIONS Please order **one** of the following handle kits to complete the product (see p. 245 for details):

M80-9180-14-xx



M80-9180-24-xx



M80-9180-34-xx

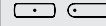

ASSEMBLED PRODUCT IMAGES

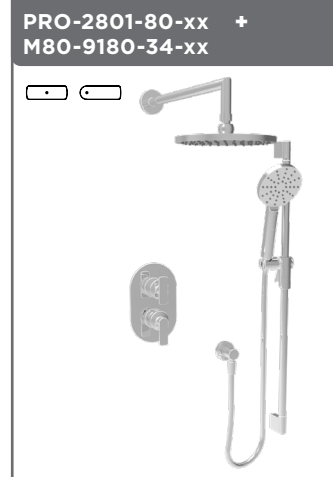
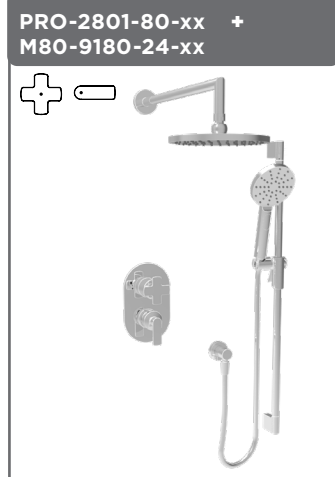

PRO-2802-80-xx
PRR-2802-80-xx*

Complete pressure balanced shower kit without handle

CC	KK	LL	BB	NN/YY	VV/TT	GG
1735	2256	2603	2603	2256	2776	3817

Available Q3 2023



- Features**
- A- 2 accessories kit
 - B- Max: 2 gpm - 80 psi (per accessory)
 - C- 3-spray hand shower
 - D- 2 accessories can work together
- Includes**
- B80-9182-00-xx** Type P valve with 2-way diverter without handle
 - TET-0811-02-xx** 8" square shower head
 - BRA-1612-66-xx** 16" shower arm
 - DGL-2584-53-xx** 3-spray sliding shower bar
 - RAC-9001-16-xx** Wall-mount supply elbow

Ecological options	Codes	Features are the same, except:
CEC	PRO-2802-80-xx-NS	B- Max: 1.75 gpm - 80 psi (per accessory)
	TRO-2802-80-xx-NS + RVA-9181-00-NS-B	D- 1 accessory works at a time

TRIM ONLY

TRO-2802-80-xx	CC	KK	LL	BB	NN/YY	VV/TT	GG
TRR-2802-80-xx*	1261	1782	2129	2129	1782	2302	3343

- ROUGH VALVES** Please order **one** of the following rough valves to complete the trim:
- | | | |
|----------------------|-----------------------------------------------------------------|-----|
| RVA-9181-00-B | 2-way type P rough - 1/2" male NPT or welded copper connections | 474 |
| RVA-9181-PO-B | 2-way type P rough - PEX connections | 474 |

HANDLE OPTIONS Please order **one** of the following handle kits to complete the product (see p. 246 for details):

M80-9180-14-xx		M80-9180-24-xx		M80-9180-34-xx	
-----------------------	--	-----------------------	--	-----------------------	--

ASSEMBLED PRODUCT IMAGES

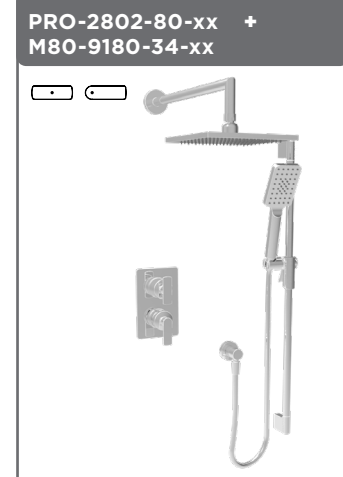
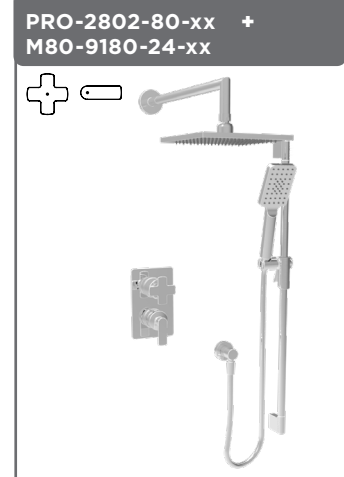
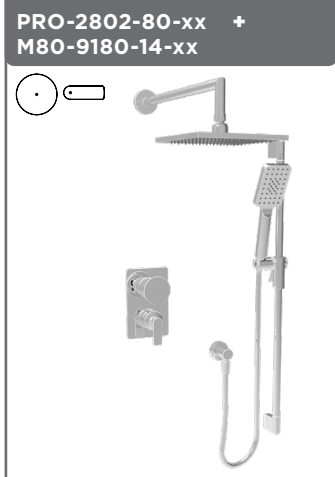

Finishes:
CC = chrome, KK = matte black, LL = satin brass, BB = white, NN = brushed nickel, YY = polished nickel, TT = venetian bronze, VV = satin copper, GG = gold

* With 6" ceiling mount shower arm

AIR B80

PRO-2811-80-xx PRR-2811-80-xx*

Complete pressure balanced shower kit without handle

CC	KK
1795	2334

Available
Q3 2023



Features

- A- 2 accessories kit
- B- Max: 2 gpm - 80 psi (per accessory)
- C- 3-spray hand shower
- D- 2 accessories can work together

Includes

- B80-9181-00-xx** Type P valve with 2-way diverter without handle
- TET-1013-01-xx** 10" round shower head
- BRA-1612-66-xx** 16" shower arm
- DGL-2580-53-xx** 3-spray sliding shower bar
- RAC-9001-16-xx** Wall-mount supply elbow

Ecological options CEC

Codes

PRO-2811-80-xx-NS
TRO-2811-80-xx-NS + RVA-9181-00-NS-B

Features are the same, **except:**

B- Max: 1.75 gpm - 80 psi (per accessory)
D- 1 accessory works at a time

TRIM ONLY

TRO-2811-80-xx TRR-2811-80-xx*

CC	KK
1321	1860

ROUGH VALVES Please order **one** of the following rough valves to complete the trim:

RVA-9181-00-B

2-way type P rough - 1/2" male NPT or welded copper connections

474

RVA-9181-PO-B

2-way type P rough - PEX connections

474

HANDLE OPTIONS Please order **one** of the following handle kits to complete the product (see p. 245 for details):

M80-9180-14-xx



M80-9180-24-xx

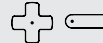

M80-9180-34-xx



ASSEMBLED PRODUCT IMAGES

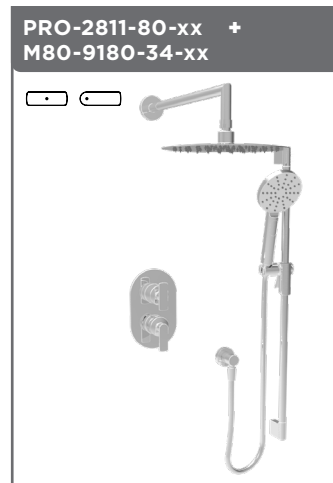
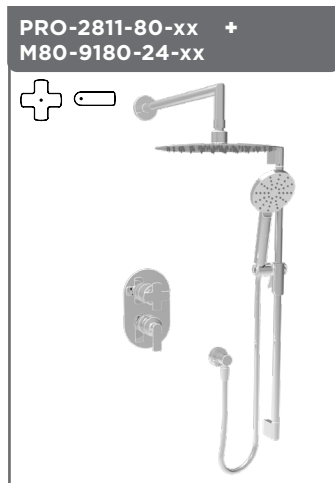
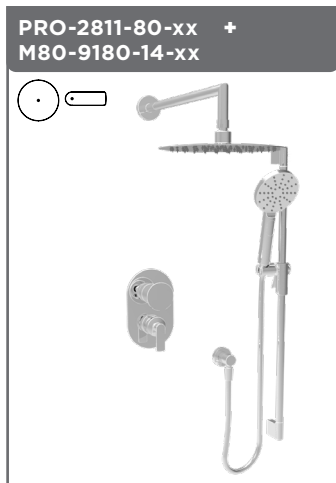

PRO-2812-80-xx
PRR-2812-80-xx*

Complete pressure balanced shower kit without handle

CC	KK
1825	2373

Available Q3 2023



Features	Includes
A- 2 accessories kit	B80-9182-00-xx Type P valve with 2-way diverter without handle
B- Max: 2 gpm - 80 psi (per accessory)	TET-1208-01-xx 12" x 8" rectangular shower head
C- 3-spray hand shower	BRA-1612-66-xx 16" shower arm
D- 2 accessories can work together	DGL-2584-53-xx 3-spray sliding shower bar
	RAC-9001-16-xx Wall-mount supply elbow

Ecological options CEC	Codes	Features are the same, except:
	PRO-2812-80-xx-NS	B- Max: 1.75 gpm - 80 psi (per accessory)
	TRO-2812-80-xx-NS + RVA-9181-00-NS-B	D- 1 accessory works at a time

TRIM ONLY

TRO-2812-80-xx TRR-2812-80-xx*	CC	KK
	1351	1899

ROUGH VALVES Please order **one** of the following rough valves to complete the trim:

RVA-9181-00-B	2-way type P rough - 1/2" male NPT or welded copper connections	474
RVA-9181-PO-B	2-way type P rough - PEX connections	474

HANDLE OPTIONS Please order **one** of the following handle kits to complete the product (see p. 246 for details):

M80-9180-14-xx		M80-9180-24-xx		M80-9180-34-xx	
-----------------------	--	-----------------------	--	-----------------------	--

ASSEMBLED PRODUCT IMAGES

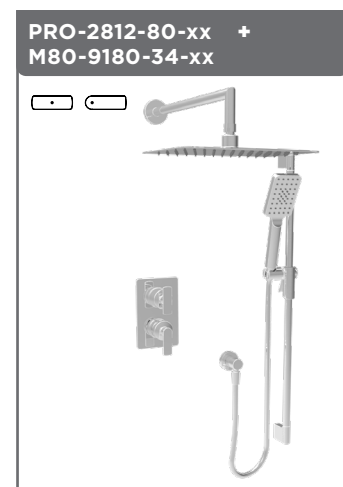
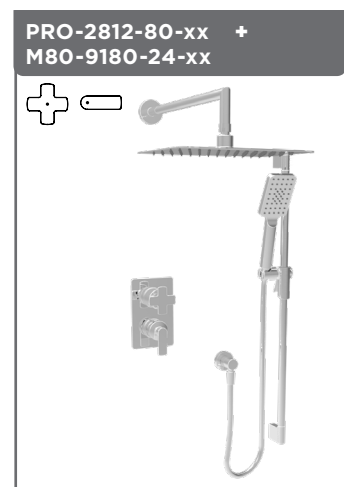
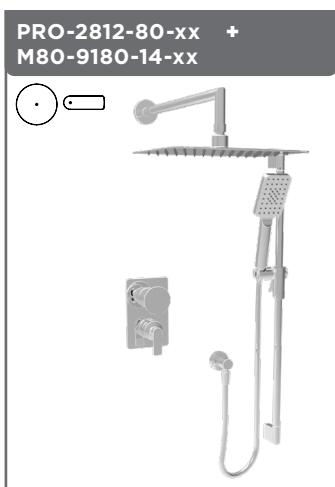

Finishes:
CC = chrome, KK = matte black, LL = satin brass, BB = white, NN = brushed nickel, YY = polished nickel, TT = venetian bronze, VV = satin copper, GG = gold

AIR B80

PRO-2891-80-xx PRR-2891-80-xx*

Available Q3 2023



Complete pressure balanced shower kit without handle

CC	KK	LL	BB	NN/YY	VV/TT	GG
1495	1944	2243	2243	1944	2392	3289

Features

- A- 2 accessories kit
- B- Max: 2 gpm - 80 psi (per accessory)
- C- 1-spray hand shower
- D- 2 accessories can work together

Includes

- B80-9181-00-xx** Type P valve with 2-way diverter without handle
- TET-0810-01-xx** 8" round shower head
- BRA-1612-66-xx** 16" shower arm
- DSP-2604-19-xx** Hand shower on wall-mounted supply elbow

Ecological options CEC

Codes

- PRO-2891-80-xx-NS
- TRO-2891-80-xx-NS + RVA-9181-00-NS-B

Features are the same, except:

- B- Max: 1.75 gpm - 80 psi (per accessory)
- D- 1 accessory works at a time

TRIM ONLY

TRO-2891-80-xx TRR-2891-80-xx*

CC	KK	LL	BB	NN/YY	VV/TT	GG
1021	1470	1769	1769	1470	1918	2815

ROUGH VALVES Please order **one** of the following rough valves to complete the trim:

RVA-9181-00-B

2-way type P rough - 1/2" male NPT or welded copper connections

474

RVA-9181-PO-B

2-way type P rough - PEX connections

474

HANDLE OPTIONS Please order **one** of the following handle kits to complete the product (see p. 245 for details):

M80-9180-14-xx



M80-9180-24-xx



M80-9180-34-xx

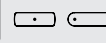

ASSEMBLED PRODUCT IMAGES



PRO-2892-80-xx PRR-2892-80-xx*

Available Q3 2023



Complete pressure balanced shower kit without handle

CC	KK	LL	BB	NN/YY	VV/TT	GG
1520	1976	2280	2280	1976	2432	3344

Features

- A- 2 accessories kit
- B- Max: 2 gpm - 80 psi (per accessory)
- C- 1-spray hand shower
- D- 2 accessories can work together

Includes

- B80-9182-00-xx** Type P valve with 2-way diverter without handle
- TET-0811-02-xx** 8" square shower head
- BRA-1612-66-xx** 16" shower arm
- DSP-2604-19-xx** Hand shower on wall-mounted supply elbow

Ecological options CEC

Codes

PRO-2892-80-xx-NS
TRO-2892-80-xx-NS + RVA-9181-00-NS-B

Features are the same, except:

B- Max: 1.75 gpm - 80 psi (per accessory)
D- 1 accessory works at a time

TRIM ONLY

TRO-2892-80-xx TRR-2892-80-xx*

CC	KK	LL	BB	NN/YY	VV/TT	GG
1046	1502	1806	1806	1502	1958	2870

ROUGH VALVES Please order **one** of the following rough valves to complete the trim:

RVA-9181-00-B

2-way type P rough - 1/2" male NPT or welded copper connections

474

RVA-9181-PO-B

2-way type P rough - PEX connections

474

HANDLE OPTIONS Please order **one** of the following handle kits to complete the product (see p. 246 for details):

M80-9180-14-xx



M80-9180-24-xx



M80-9180-34-xx



ASSEMBLED PRODUCT IMAGES

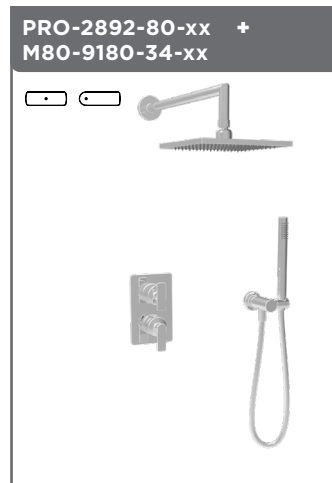

Finishes:

CC = chrome, KK = matte black, LL = satin brass, BB = white, NN = brushed nickel, YY = polished nickel, TT = venetian bronze, VV = satin copper, GG = gold

* With 6" ceiling mount shower arm

AIR B80

PRO-2901-80-xx
PRR-2901-80-xx*

Complete pressure balanced shower kit without handle

CC

1975



Available Q3 2023

Features

- A- 3 accessories kit
- B- 5 gpm - 60 psi (bath spout)
- C- Max: 2 gpm - 80 psi (shower accessories)
- D- 3-spray hand shower
- E- 2 accessories can work together

Includes

- B80-9191-00-xx** Type P valve with 3-way diverter without handle
- BEC-0520-73-xx** 7" round tub spout without diverter
- TET-0813-01-xx** 8" round shower head
- BRA-1612-66-xx** 16" shower arm
- DGL-2580-53-xx** 3-spray sliding shower bar
- RAC-9001-16-xx** Wall-mount supply elbow

Ecological options <small>CEC</small>	Codes	Features are the same, except:	
	PRO-2901-80-xx-NS		C- Max: 1.75 gpm - 80 psi (shower accessories)
	TRO-2901-80-xx-NS + RVA-9191-00-NS-B		E- 1 accessory works at a time

TRIM ONLY

TRO-2901-80-xx TRR-2901-80-xx*	CC
	1446

ROUGH VALVES Please order **one** of the following rough valves to complete the trim:

RVA-9191-00-B	3-way type P rough - 1/2" male NPT or welded copper connections	529
----------------------	-----------------------------------------------------------------	-----

RVA-9191-PO-B	3-way type P rough - PEX connections	529
----------------------	--------------------------------------	-----

HANDLE OPTIONS Please order **one** of the following handle kits to complete the product (see p. 247 for details):

M80-9180-14-xx	M80-9180-24-xx	M80-9180-34-xx
-----------------------	-----------------------	-----------------------

ASSEMBLED PRODUCT IMAGES

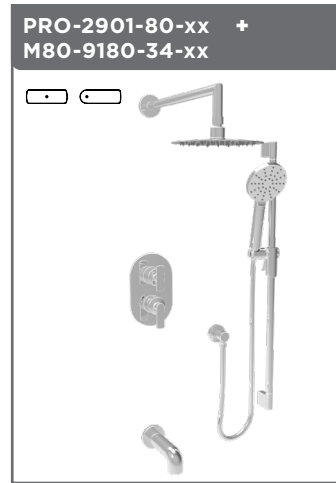
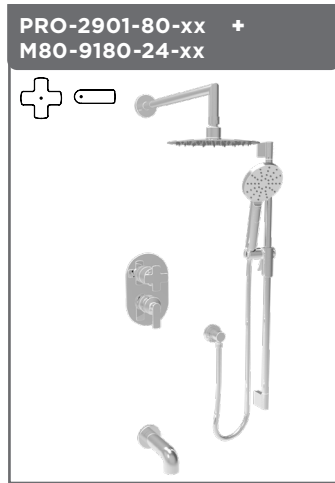
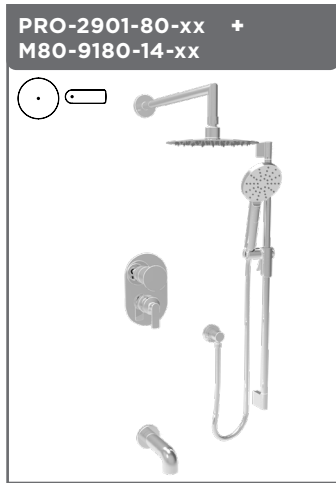

PRO-2902-80-xx PRR-2902-80-xx*

Complete pressure balanced shower kit without handle

CC

1995



Available
Q3 2023

Features

- A- 3 accessories kit
- B- 5 gpm - 60 psi (bath spout)
- C- Max: 2 gpm - 80 psi (shower accessories)
- D- 3-spray hand shower
- E- 2 accessories can work together

Includes

- B80-9192-00-xx** Type P valve with 3-way diverter without handle
- BEC-0520-73-xx** 7" round tub spout without diverter
- TET-0814-01-xx** 8" square shower head
- BRA-1612-66-xx** 16" shower arm
- DGL-2584-53-xx** 3-spray sliding shower bar
- RAC-9001-16-xx** Wall-mount supply elbow

Ecological options CEC

Codes

PRO-2902-80-xx-NS
TRO-2902-80-xx-NS + RVA-9191-00-NS-B

Features are the same, **except:**

C- Max: 1.75 gpm - 80 psi (shower accessories)
E- 1 accessory works at a time

TRIM ONLY

TRO-2902-80-xx
TRR-2902-80-xx*

CC

1466

ROUGH VALVES Please order **one** of the following rough valves to complete the trim:

RVA-9191-00-B

3-way type P rough - 1/2" male NPT or welded copper connections

529

RVA-9191-PO-B

3-way type P rough - PEX connections

529

HANDLE OPTIONS Please order **one** of the following handle kits to complete the product (see p. 248 for details):

M80-9180-14-xx



M80-9180-24-xx



M80-9180-34-xx



ASSEMBLED PRODUCT IMAGES

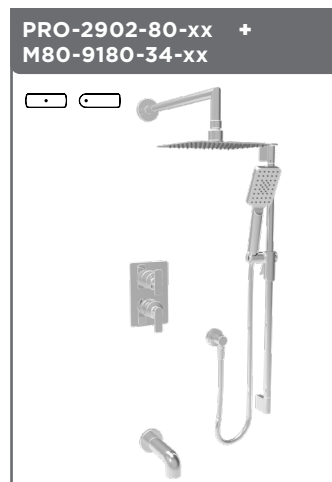
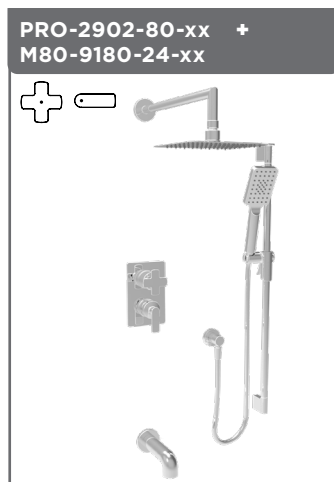
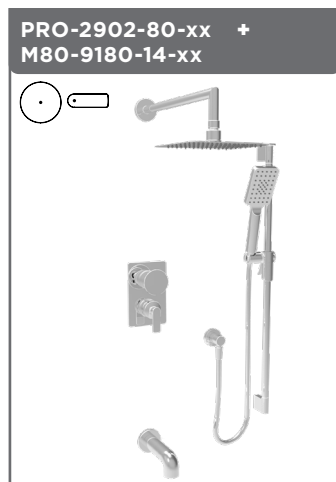

Finishes:

CC = chrome, KK = matte black, LL = satin brass, BB = white, NN = brushed nickel,
YY = polished nickel, TT = venetian bronze, VV = satin copper, GG = gold

* With 6" ceiling mount shower arm

AIR B80

PRO-3301-80-xx PRR-3301-80-xx*

Available
Q3 2023

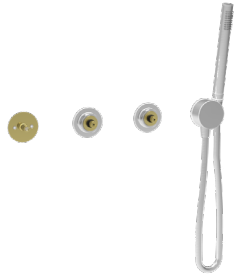

Complete thermostatic shower kit without handle

CC	KK	LL	BB	NN/YY	VV/TT	GG
2264	2943	3396	3396	2943	3622	4981

Features

- A- 2 accessories kit
- B- Max: 2 gpm - 80 psi (per accessory)
- C- 1-spray hand shower
- D- 2 accessories can work together
- E- Hook as part of the thermostatic valve trim

Includes

- B80-9453-00-xx** 3/4" thermostatic valve without handle
- B80-9560-02-xx** 2-port diverter with off without handle
- TET-1010-01-xx** 10" round shower head
- BRA-1612-66-xx** 16" shower arm
- DSP-2604-21-xx** Hand shower on wall-mounted supply elbow

Ecological options CEC

Codes

PRO-3301-80-xx-NS
TRO-3301-80-xx-NS + RVA-3453-00-B +
RVA-9562-00-NS-B

Features are the same, except:

- B- Max: 1.75 gpm - 80 psi (per accessory)
- D- 1 accessory works at a time

TRIM ONLY

TRO-3301-80-xx TRR-3301-80-xx*

CC	KK	LL	BB	NN/YY	VV/TT	GG
1316	1995	2448	2448	1995	2674	4033

ROUGH VALVES Please order **all** of the following rough valves to complete the trim:

RVA-3453-00-B

Type T rough - 3/4" female NPT connections

649

RVA-9562-00-B

2-port diverter rough - 1/2" male NPT or welded copper connections

299

ATTENTION! To complete this shower kit, you must order **two** handle kits (M80-9453-X0-xx et M80-9500-X0-xx).

HANDLE 1 OPTIONS Please order **one** of the following handle kits to complete the product (see p. 251 for details):

M80-9453-10-xx

Circular handle



M80-9453-30-xx

Symmetrical lever handle



M80-9453-20-xx

Cross handle



M80-9453-40-xx

Asymmetrical lever handle



HANDLE 2 OPTIONS Please order **one** of the following handle kits to complete the product (see p. 260 for details):

M80-9500-10-xx

Circular handle



M80-9500-30-xx

Symmetrical lever handle



M80-9500-20-xx

Cross handle



M80-9500-40-xx

Asymmetrical lever handle



ASSEMBLED PRODUCT IMAGES

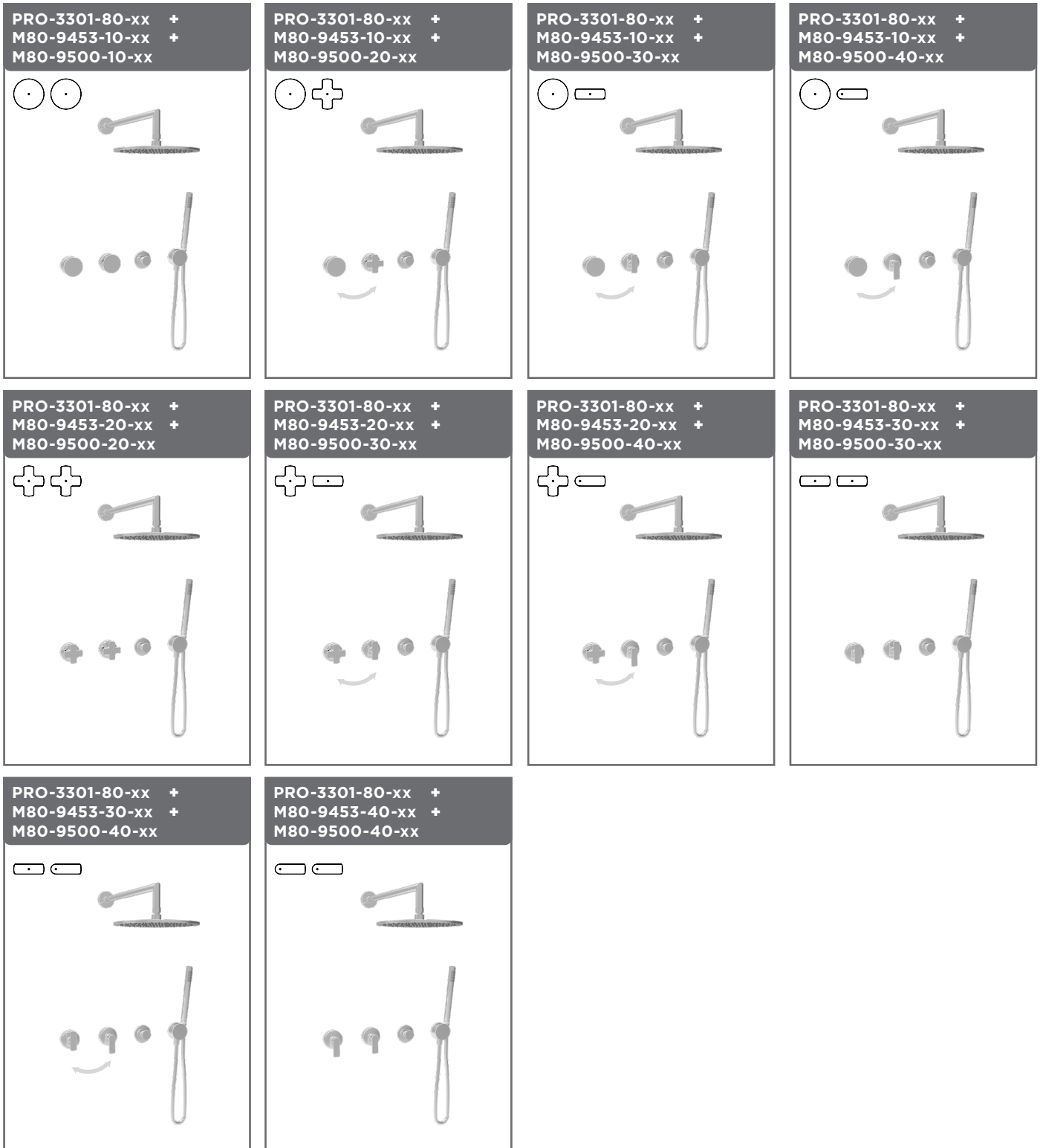

Finishes:

CC = chrome, KK = matte black, LL = satin brass, BB = white, NN = brushed nickel, YY = polished nickel, TT = venetian bronze, VV = satin copper, GG = gold

* With 6" ceiling mount shower arm

AIR B80

PRO-3302-80-xx PRR-3302-80-xx*

Available
Q3 2023

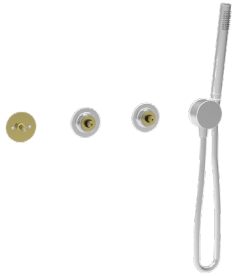

Complete thermostatic shower kit without handle

CC	KK	LL	BB	NN/YY	VV/TT	GG
2295	2984	3443	3443	2984	3672	5049

Features

- A- 2 accessories kit
- B- Max: 2 gpm - 80 psi (per accessory)
- C- 1-spray hand shower
- D- 2 accessories can work together
- E- Hook as part of the thermostatic valve trim

Includes

- B80-9453-00-xx** 3/4" thermostatic valve without handle
- B80-9560-02-xx** 2-port diverter with off without handle
- TET-1011-01-xx** 10" square shower head
- BRA-1612-66-xx** 16" shower arm
- DSP-2604-21-xx** Hand shower on wall-mounted supply elbow

Ecological options CEC

Codes

PRO-3302-80-xx-NS
TRO-3302-80-xx-NS + RVA-3453-00-B +
RVA-9562-00-NS-B

Features are the same, except:

- B- Max: 1.75 gpm - 80 psi (per accessory)
- D- 1 accessory works at a time

TRIM ONLY

TRO-3302-80-xx TRR-3302-80-xx*

CC	KK	LL	BB	NN/YY	VV/TT	GG
1347	2036	2495	2495	2036	2724	4101

ROUGH VALVES Please order **all** of the following rough valves to complete the trim:

RVA-3453-00-B

Type T rough - 3/4" female NPT connections

649

RVA-9562-00-B

2-port diverter rough - 1/2" male NPT or welded copper connections

299

ATTENTION! To complete this shower kit, you must order **two** handle kits (M80-9453-X0-xx et M80-9500-X0-xx).

HANDLE 1 OPTIONS Please order **one** of the following handle kits to complete the product (see p. 251 for details):

M80-9453-10-xx

Circular handle



M80-9453-30-xx

Symmetrical lever handle



M80-9453-20-xx

Cross handle



M80-9453-40-xx

Asymmetrical lever handle



HANDLE 2 OPTIONS Please order **one** of the following handle kits to complete the product (see p. 260 for details):

M80-9500-10-xx

Circular handle



M80-9500-30-xx

Symmetrical lever handle



M80-9500-20-xx

Cross handle



M80-9500-40-xx

Asymmetrical lever handle



ASSEMBLED PRODUCT IMAGES

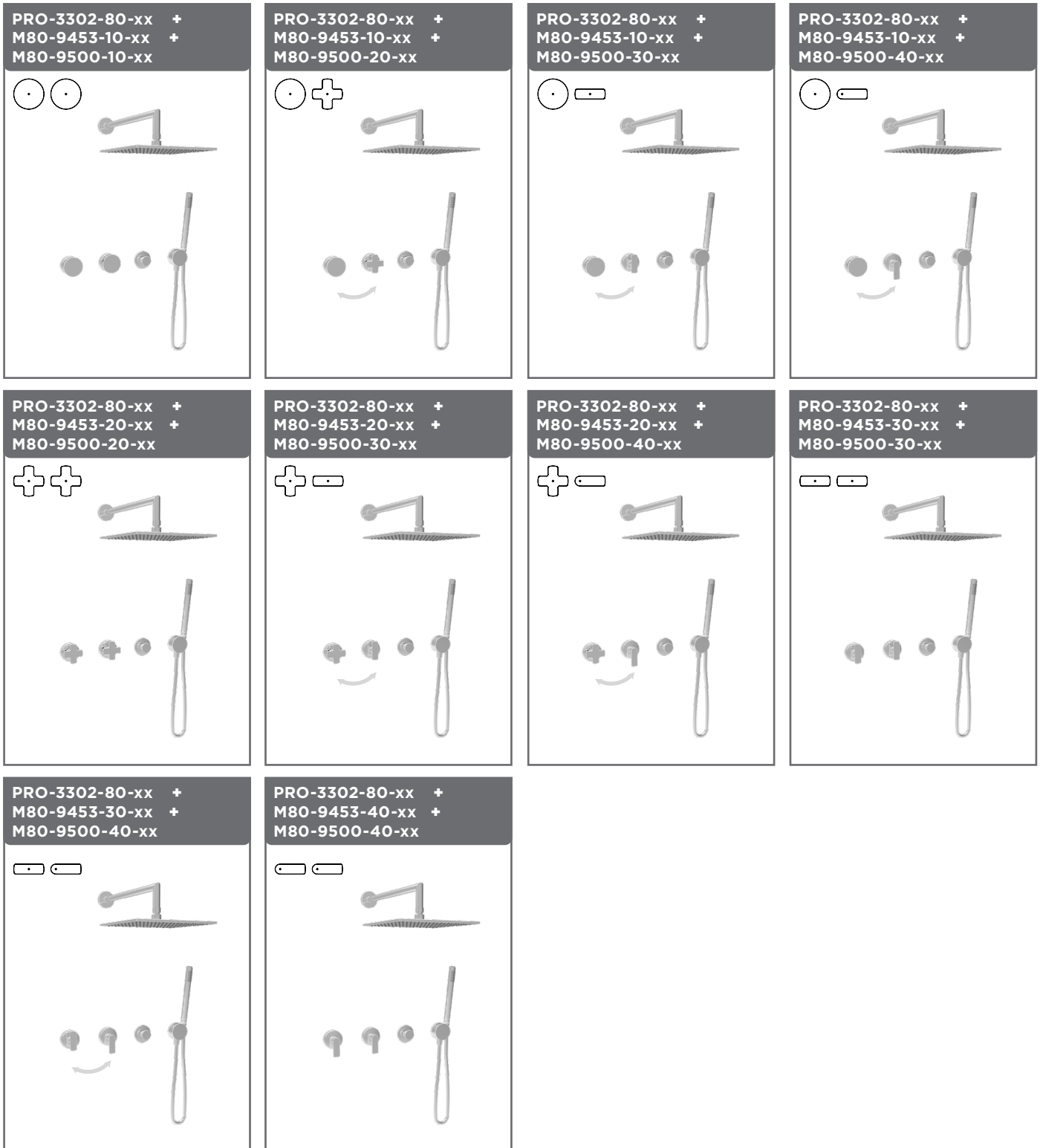

Finishes:

CC = chrome, KK = matte black, LL = satin brass, BB = white, NN = brushed nickel,
YY = polished nickel, TT = venetian bronze, VV = satin copper, GG = gold

* With 6" ceiling mount shower arm

AIR B80

PRO-3311-80-xx

Available Q3 2023



Complete thermostatic shower kit without handle

CC	KK	LL	BB	NN/YY	VV/TT	GG
1830	2379	2745	2745	2379	2928	4026

Features

- A- 2 accessories kit
- B- Max: 2 gpm - 80 psi (per accessory)
- C- 1-spray hand shower
- D- 2 accessories can work together
- E- Hook as part of the thermostatic valve trim

Includes

- B80-9453-00-xx** 3/4" thermostatic valve without handle
- B80-9560-02-xx** 2-port diverter with off without handle
- BEC-0520-37-xx** Modern round tub spout without diverter
- DSP-2604-21-xx** Hand shower on wall-mounted supply elbow

Ecological options CEC

Codes

PRO-3311-80-xx-NS
 TRO-3311-80-xx-NS + RVA-3453-00-B +
 RVA-9562-00-NS-B

Features are the same, except:

- B- Max: 1.75 gpm - 80 psi (per accessory)
- D- 1 accessory works at a time

TRIM ONLY

TRO-3311-80-xx

CC	KK	LL	BB	NN/YY	VV/TT	GG
882	1431	1797	1797	1431	1980	3078

ROUGH VALVES Please order **all** of the following rough valves to complete the trim:

RVA-3453-00-B

Type T rough - 3/4" female NPT connections

649

RVA-9562-00-B

2-port diverter rough - 1/2" male NPT or welded copper connections

299

ATTENTION! To complete this shower kit, you must order **two** handle kits (M80-9453-X0-xx et M80-9500-X0-xx).

HANDLE 1 OPTIONS Please order **one** of the following handle kits to complete the product (see p. 251 for details):

M80-9453-10-xx	Circular handle		M80-9453-30-xx	Symmetrical lever handle	
M80-9453-20-xx	Cross handle		M80-9453-40-xx	Asymmetrical lever handle	

HANDLE 2 OPTIONS Please order **one** of the following handle kits to complete the product (see p. 260 for details):

M80-9500-10-xx	Circular handle		M80-9500-30-xx	Symmetrical lever handle	
M80-9500-20-xx	Cross handle		M80-9500-40-xx	Asymmetrical lever handle	

ASSEMBLED PRODUCT IMAGES

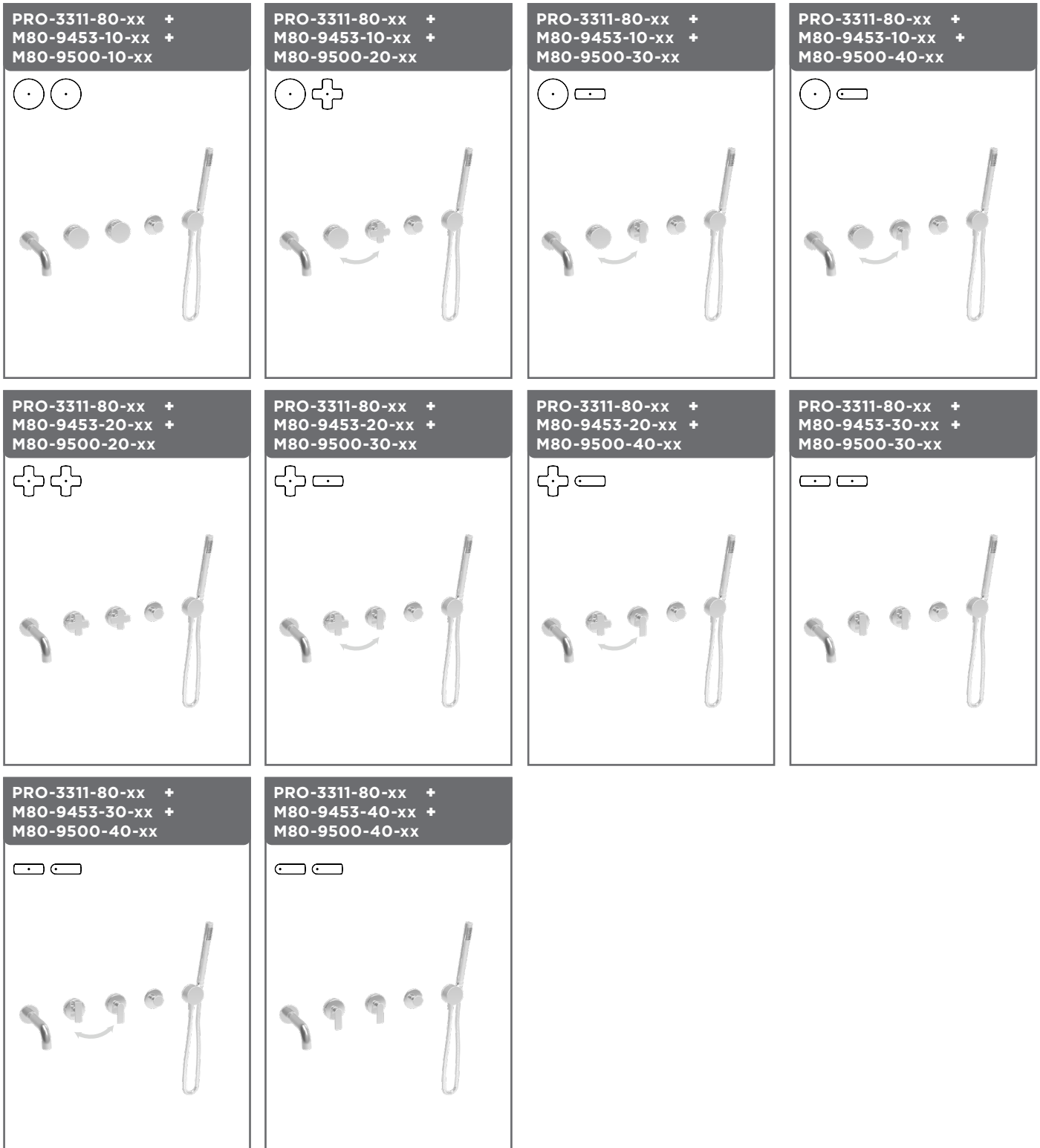

Finishes:

CC = chrome, KK = matte black, LL = satin brass, BB = white, NN = brushed nickel, YY = polished nickel, TT = venetian bronze, VV = satin copper, GG = gold

* With 6" ceiling mount shower arm

AIR B80

PRO-4201-80-xx PRR-4201-80-xx*

Complete thermostatic pressure balanced shower kit without handle

CC	KK	LL	BB	NN/YY	VV/TT	GG
2045	2659	3068	3068	2659	3272	4499



Features

- A- 2 accessories kit
- B- Max: 2 gpm - 80 psi (per accessory)
- C- 3-spray hand shower
- D- 2 accessories can work together

Includes

- B80-9521-00-xx** TP shower control valve with 2-way diverter without handle
- TET-1010-01-xx** 10" round shower head
- BRA-1612-66-xx** 16" shower arm
- DGL-2580-53-xx** 3-spray sliding shower bar
- RAC-9001-16-xx** Wall-mount supply elbow

Ecological options CEC

Codes

PRO-4201-80-xx-NS
TRO-4201-80-xx-NS + RVA-9521-00-NS-B

Features are the same, except:

B- Max: 1.75 gpm - 80 psi (per accessory)
D- 1 accessory works at a time

TRIM ONLY

TRO-4201-80-xx TRR-4201-80-xx*

CC	KK	LL	BB	NN/YY	VV/TT	GG
1360	1974	2383	2383	1974	2587	3814

ROUGH VALVES Please order **one** of the following rough valves to complete the trim:

RVA-9521-00-B

2-way TP rough - 1/2" male NPT or welded copper connections

685

RVA-9521-P0-B

2-way TP rough - PEX connections

685

HANDLE OPTIONS Please order **one** of the following handle kits to complete the product (see p. 252-253 for details):

M80-9520-110-xx



M80-9520-120-xx



M80-9520-130-xx



M80-9520-220-xx



M80-9520-230-xx



M80-9520-330-xx



ASSEMBLED PRODUCT IMAGES

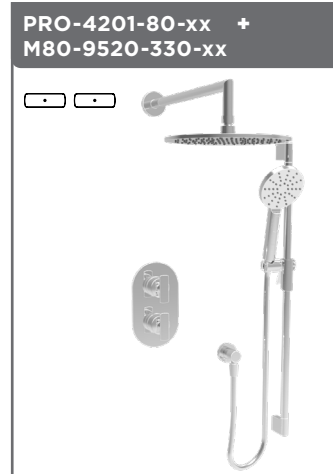
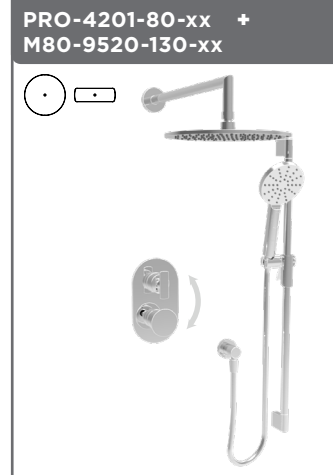
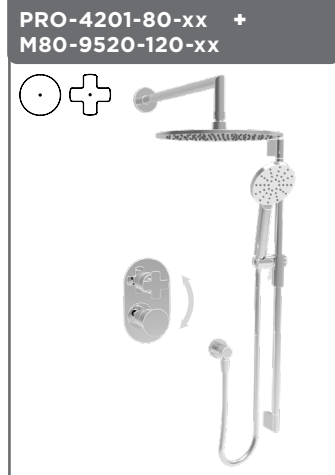

PRO-4202-80-xx PRR-4202-80-xx*

Complete thermostatic pressure balanced shower kit without handle

CC	KK	LL	BB	NN/YY	VV/TT	GG
2110	2743	3165	3165	2743	3376	4642



Features

- A- 2 accessories kit
- B- Max: 2 gpm - 80 psi (per accessory)
- C- 3-spray hand shower
- D- 2 accessories can work together

Includes

- B80-9522-00-xx** TP shower control valve with 2-way diverter without handle
- TET-1011-01-xx** 10" square shower head
- BRA-1612-66-xx** 16" shower arm
- DGL-2584-53-xx** 3-spray sliding shower bar
- RAC-9001-16-xx** Wall-mount supply elbow

Ecological options CEC

Codes

PRO-4202-80-xx-NS
TRO-4202-80-xx-NS + RVA-9521-00-NS-B

Features are the same, except:

B- Max: 1.75 gpm - 80 psi (per accessory)
D- 1 accessory works at a time

TRIM ONLY

TRO-4202-80-xx TRR-4202-80-xx*

CC	KK	LL	BB	NN/YY	VV/TT	GG
1425	2058	2480	2480	2058	2691	3957

ROUGH VALVES Please order **one** of the following rough valves to complete the trim:

RVA-9521-00-B

2-way TP rough - 1/2" male NPT or welded copper connections

685

RVA-9521-P0-B

2-way TP rough - PEX connections

685

HANDLE OPTIONS Please order **one** of the following handle kits to complete the product (see p. 254-255 for details):

M80-9520-110-xx



M80-9520-120-xx



M80-9520-130-xx



M80-9520-220-xx



M80-9520-230-xx



M80-9520-330-xx



ASSEMBLED PRODUCT IMAGES

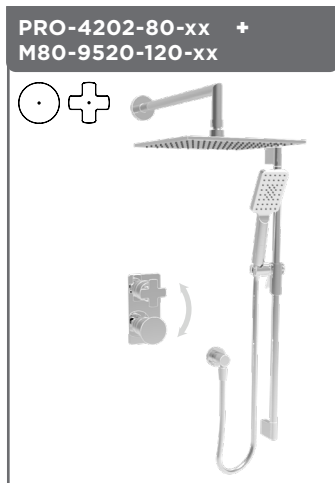
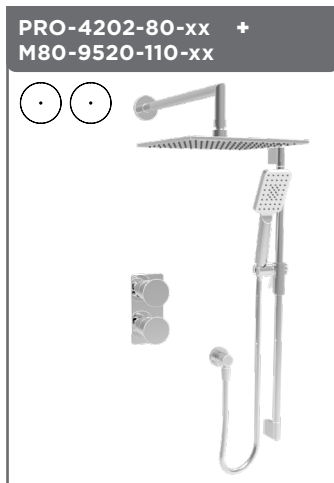

Finishes:

CC = chrome, KK = matte black, LL = satin brass, BB = white, NN = brushed nickel, YY = polished nickel, TT = venetian bronze, VV = satin copper, GG = gold

* With 6" ceiling mount shower arm

AIR B80

PRO-4211-80-xx PRR-4211-80-xx*

Complete thermostatic pressure balanced shower kit without handle

CC	KK
2075	2698



Features

- A- 2 accessories kit
- B- Max: 2 gpm - 80 psi (per accessory)
- C- 3-spray hand shower
- D- 2 accessories can work together

Includes

- B80-9521-00-xx** TP shower control valve with 2-way diverter without handle
- TET-1013-01-xx** 10" round shower head
- BRA-1612-66-xx** 16" shower arm
- DGL-2580-53-xx** 3-spray sliding shower bar
- RAC-9001-16-xx** Wall-mount supply elbow

Ecological options CEC

Codes

PRO-4211-80-xx-NS
TRO-4211-80-xx-NS + RVA-9521-00-NS-B

Features are the same, except:

B- Max: 1.75 gpm - 80 psi (per accessory)
D- 1 accessory works at a time

TRIM ONLY

TRO-4211-80-xx TRR-4211-80-xx*

CC	KK
1390	2013

ROUGH VALVES Please order **one** of the following rough valves to complete the trim:

RVA-9521-00-B

2-way TP rough - 1/2" male NPT or welded copper connections

685

RVA-9521-P0-B

2-way TP rough - PEX connections

685

HANDLE OPTIONS Please order **one** of the following handle kits to complete the product (see p. 252-253 for details):

M80-9520-110-xx



M80-9520-120-xx



M80-9520-130-xx



M80-9520-220-xx



M80-9520-230-xx



M80-9520-330-xx



ASSEMBLED PRODUCT IMAGES

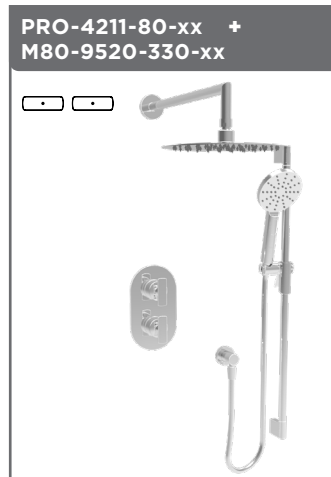
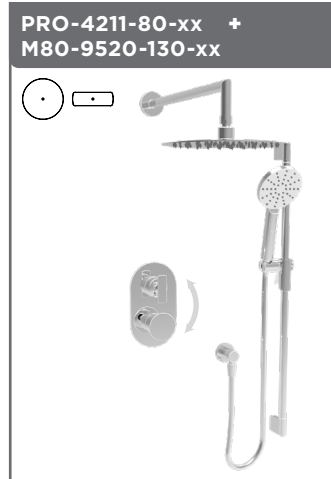
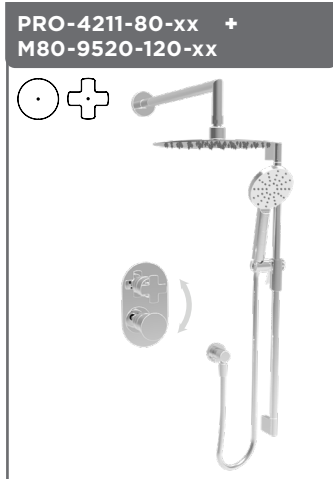

PRO-4212-80-xx PRR-4212-80-xx*

Complete thermostatic pressure balanced shower kit without handle

CC	KK
2125	2763



Features

- A- 2 accessories kit
- B- Max: 2 gpm - 80 psi (per accessory)
- C- 3-spray hand shower
- D- 2 accessories can work together

Includes

- B80-9522-00-xx** TP shower control valve with 2-way diverter without handle
- TET-1208-01-xx** 12" x 8" rectangular shower head
- BRA-1612-66-xx** 16" shower arm
- DGL-2584-53-xx** 3-spray sliding shower bar
- RAC-9001-16-xx** Wall-mount supply elbow

Ecological options CEC

Codes

PRO-4212-80-xx-NS
TRO-4212-80-xx-NS + RVA-9521-00-NS-B

Features are the same, except:

B- Max: 1.75 gpm - 80 psi (per accessory)
D- 1 accessory works at a time

TRIM ONLY

TRO-4212-80-xx
TRR-4212-80-xx*

CC	KK
1440	2078

ROUGH VALVES Please order **one** of the following rough valves to complete the trim:

RVA-9521-00-B

2-way TP rough - 1/2" male NPT or welded copper connections

685

RVA-9521-P0-B

2-way TP rough - PEX connections

685

HANDLE OPTIONS Please order **one** of the following handle kits to complete the product (see p. 254-255 for details):

M80-9520-110-xx



M80-9520-120-xx



M80-9520-130-xx



M80-9520-220-xx



M80-9520-230-xx



M80-9520-330-xx



ASSEMBLED PRODUCT IMAGES

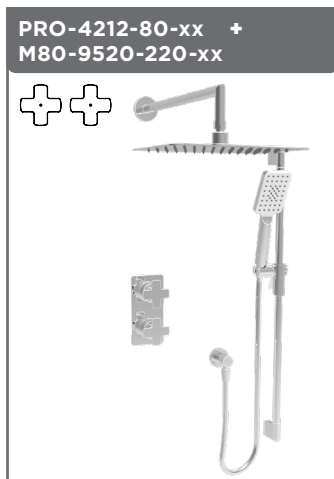
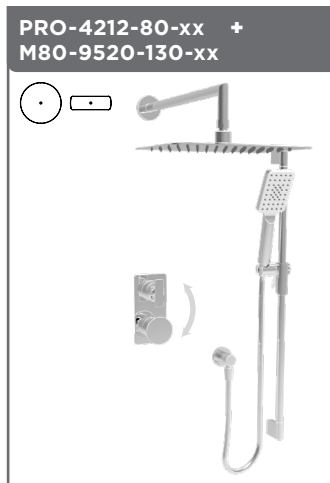
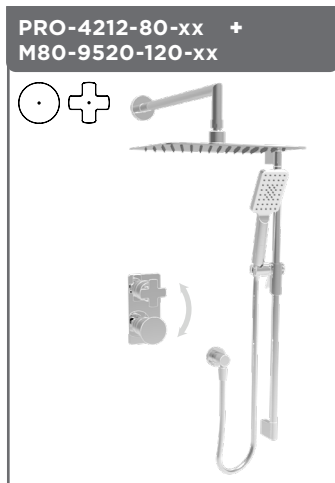
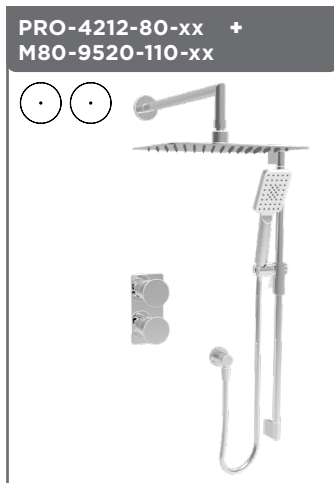

Finishes:

CC = chrome, KK = matte black, LL = satin brass, BB = white, NN = brushed nickel,
YY = polished nickel, TT = venetian bronze, VV = satin copper, GG = gold

* With 6" ceiling mount shower arm

AIR B80

PRO-4291-80-xx PRR-4291-80-xx*

Available Q3 2023



Complete thermostatic pressure balanced shower kit without handle

CC	KK	LL	BB	NN/YY	VV/TT	GG
1794	2332	2691	2691	2332	2870	3947

Features

- A- 2 accessories kit
- B- Max: 2 gpm - 80 psi (per accessory)
- C- 3-spray hand shower
- D- 2 accessories can work together

Includes

- B80-9521-00-xx** TP shower control valve with 2-way diverter without handle
- TET-1010-01-xx** 10" round shower head
- BRA-1612-66-xx** 16" shower arm
- DSP-2574-19-xx** Hand shower on wall-mounted supply elbow

Ecological options CEC

Codes

PRO-4291-80-xx-NS
TRO-4291-80-xx-NS + RVA-9521-00-NS-B

Features are the same, except:

B- Max: 1.75 gpm - 80 psi (per accessory)
D- 1 accessory works at a time

TRIM ONLY

TRO-4291-80-xx TRR-4291-80-xx*

CC	KK	LL	BB	NN/YY	VV/TT	GG
1109	1647	2006	2006	1647	2185	3262

ROUGH VALVES Please order **one** of the following rough valves to complete the trim:

RVA-9521-00-B

2-way TP rough - 1/2" male NPT or welded copper connections

685

RVA-9521-P0-B

2-way TP rough - PEX connections

685

HANDLE OPTIONS Please order **one** of the following handle kits to complete the product (see p. 252-253 for details):

M80-9520-110-xx



M80-9520-120-xx



M80-9520-130-xx



M80-9520-220-xx



M80-9520-230-xx



M80-9520-330-xx



ASSEMBLED PRODUCT IMAGES

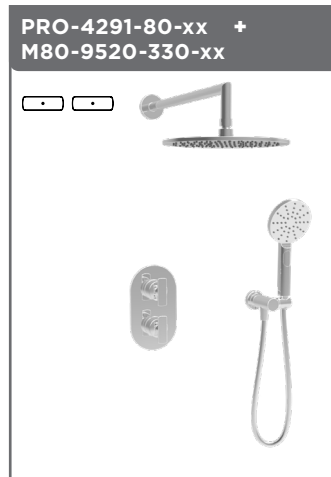
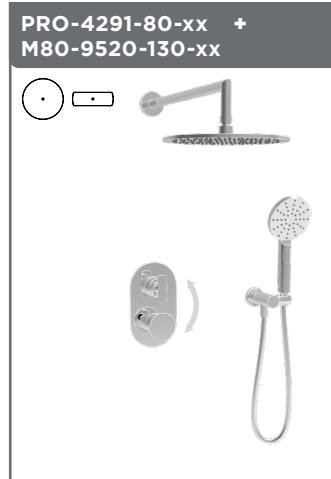
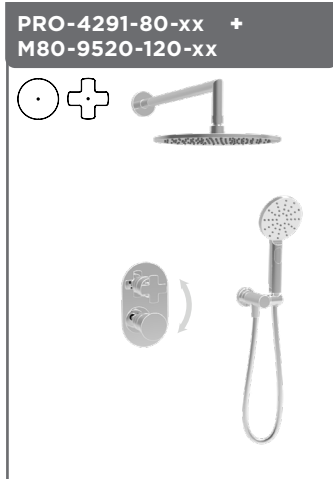

PRO-4292-80-xx PRR-4292-80-xx*

Available Q3 2023



Complete thermostatic pressure balanced shower kit without handle

CC	KK	LL	BB	NN/YY	VV/TT	GG
1860	2418	2790	2790	2418	2976	4092

Features

- A- 2 accessories kit
- B- Max: 2 gpm - 80 psi (per accessory)
- C- 3-spray hand shower
- D- 2 accessories can work together

Includes

- B80-9522-00-xx** TP shower control valve with 2-way diverter without handle
- TET-1011-01-xx** 10" square shower head
- BRA-1612-66-xx** 16" shower arm
- DSP-2584-19-xx** Hand shower on wall-mounted supply elbow

Ecological options CEC

Codes

PRO-4292-80-xx-NS
TRO-4292-80-xx-NS + RVA-9521-00-NS-B

Features are the same, except:

B- Max: 1.75 gpm - 80 psi (per accessory)
D- 1 accessory works at a time

TRIM ONLY

TRO-4292-80-xx TRR-4292-80-xx*

CC	KK	LL	BB	NN/YY	VV/TT	GG
1175	1733	2105	2105	1733	2291	3407

ROUGH VALVES Please order **one** of the following rough valves to complete the trim:

RVA-9521-00-B

2-way TP rough - 1/2" male NPT or welded copper connections

685

RVA-9521-P0-B

2-way TP rough - PEX connections

685

HANDLE OPTIONS Please order **one** of the following handle kits to complete the product (see p. 254-255 for details):

M80-9520-110-xx



M80-9520-120-xx



M80-9520-130-xx



M80-9520-220-xx



M80-9520-230-xx



M80-9520-330-xx



ASSEMBLED PRODUCT IMAGES

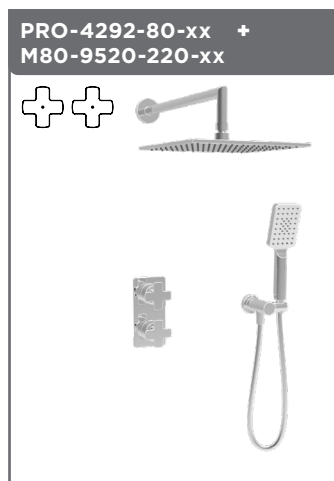
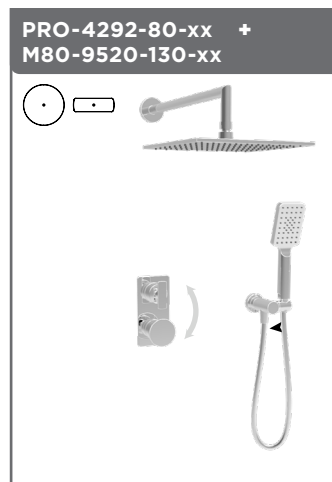
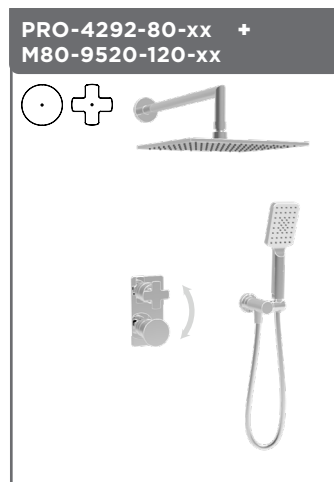
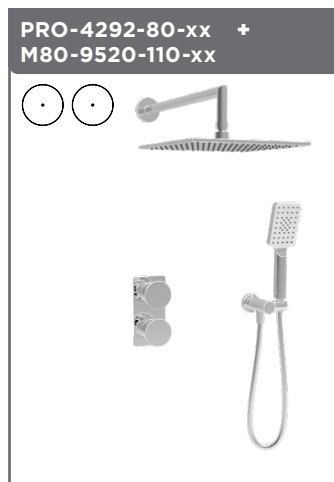

Finishes:

CC = chrome, KK = matte black, LL = satin brass, BB = white, NN = brushed nickel, YY = polished nickel, TT = venetian bronze, VV = satin copper, GG = gold

* With 6" ceiling mount shower arm

AIR B80

PRO-4301-80-xx PRR-4301-80-xx*

Complete thermostatic pressure balanced shower kit without handle

CC	KK	LL	BB	NN/YY	VV/TT	GG
2315	3010	3473	3473	3010	3704	5093



Available Q3 2023

Features

- A- 3 accessories kit
- B- 7.9 gpm - 60 psi (bath spout)
- C- Max: 2 gpm - 80 psi (shower accessory)
- D- 3-spray hand shower
- E- 2 accessories can work together

Includes

- B80-9531-00-xx** TP shower control valve with 3-way diverter without handle
- BEC-0520-37-xx** Modern round tub spout without diverter
- TET-1010-01-xx** 10" round shower head
- BRA-1612-66-xx** 16" shower arm
- DGL-2580-53-xx** 3-spray sliding shower bar
- RAC-9001-16-xx** Wall-mount supply elbow

Ecological options CEC

Codes

- PRO-4301-80-xx-NS
- TRO-4301-80-xx-NS + RVA-9531-00-NS-B

Features are the same, except:

- C- Max: 1.75 gpm - 80 psi (shower accessories)
- E- 1 accessory works at a time

TRIM ONLY

TRO-4301-80-xx TRR-4301-80-xx*

CC	KK	LL	BB	NN/YY	VV/TT	GG
1520	2215	2678	2678	2215	2909	4298

ROUGH VALVES Please order **one** of the following rough valves to complete the trim:

RVA-9531-00-B	3-way TP rough - 1/2" male NPT or welded copper connections	795
RVA-9531-P0-B	3-way TP rough - PEX connections	795

HANDLE OPTIONS Please order **one** of the following handle kits to complete the product (see p. 256-257 for details):

M80-9520-110-xx		M80-9520-120-xx		M80-9520-130-xx	
M80-9520-220-xx		M80-9520-230-xx		M80-9520-330-xx	

ASSEMBLED PRODUCT IMAGES

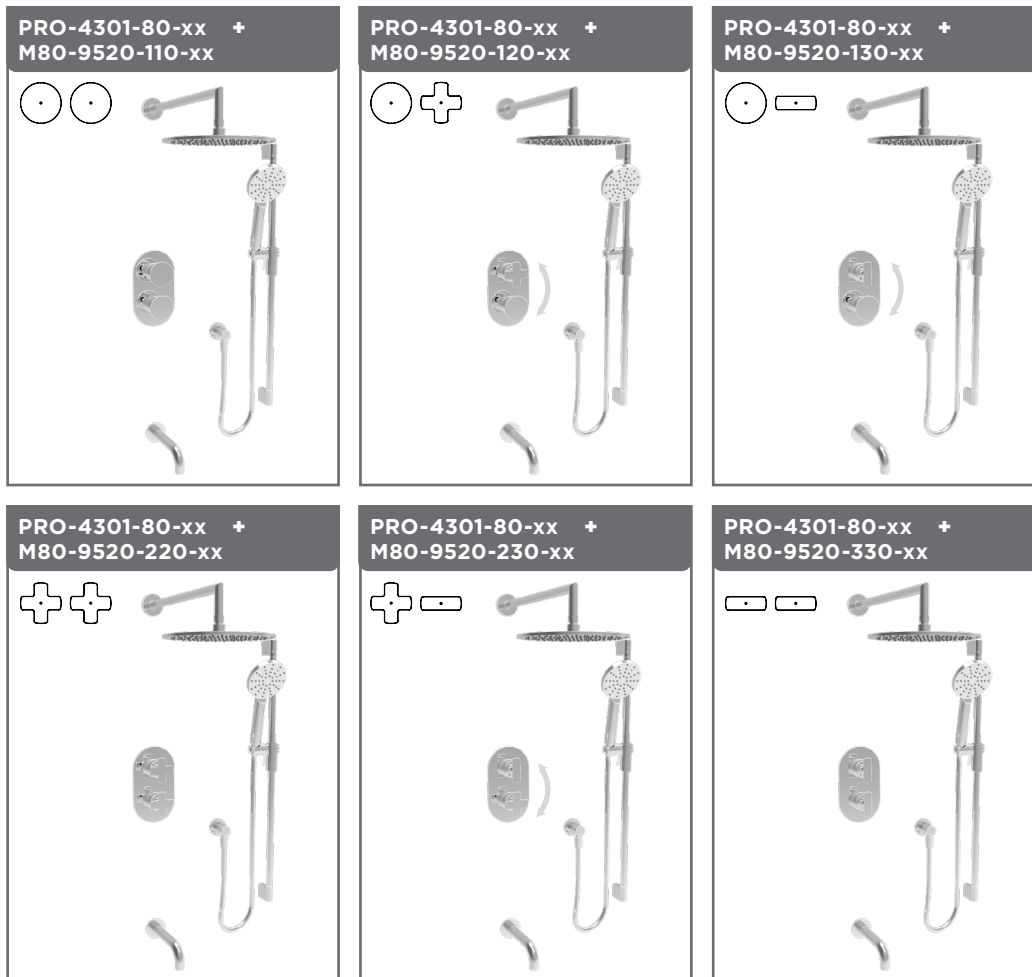

PRO-4302-80-xx PRR-4302-80-xx*



Available Q3 2023

Complete thermostatic pressure balanced shower kit without handle

CC	KK	LL	BB	NN/YY	VV/TT	GG
2380	3094	3570	3570	3094	3808	5236

Features

- A- 3 accessories kit
- B- 7.9 gpm - 60 psi (bath spout)
- C- Max: 2 gpm - 80 psi (shower accessory)
- D- 3-spray hand shower
- E- 2 accessories can work together

Includes

- B80-9532-00-xx** TP shower control valve with 3-way diverter without handle
- BEC-0520-37-xx** Modern round tub spout without diverter
- TET-1011-01-xx** 10" square shower head
- BRA-1612-66-xx** 16" shower arm
- DGL-2584-53-xx** 3-spray sliding shower bar
- RAC-9001-16-xx** Wall-mount supply elbow

Ecological options CEC

Codes

PRO-4302-80-xx-NS
TRO-4302-80-xx-NS + RVA-9531-00-NS-B

Features are the same, except:

C- Max: 1.75 gpm - 80 psi (shower accessories)
E- 1 accessory works at a time

TRIM ONLY

TRO-4302-80-xx TRR-4302-80-xx*

CC	KK	LL	BB	NN/YY	VV/TT	GG
1585	2299	2775	2775	2299	3013	4441

ROUGH VALVES Please order **one** of the following rough valves to complete the trim:

RVA-9531-00-B	3-way TP rough - 1/2" male NPT or welded copper connections	795
RVA-9531-P0-B	3-way TP rough - PEX connections	795

HANDLE OPTIONS Please order **one** of the following handle kits to complete the product (see p. 258-259 for details):

M80-9520-110-xx		M80-9520-120-xx		M80-9520-130-xx	
M80-9520-220-xx		M80-9520-230-xx		M80-9520-330-xx	

ASSEMBLED PRODUCT IMAGES

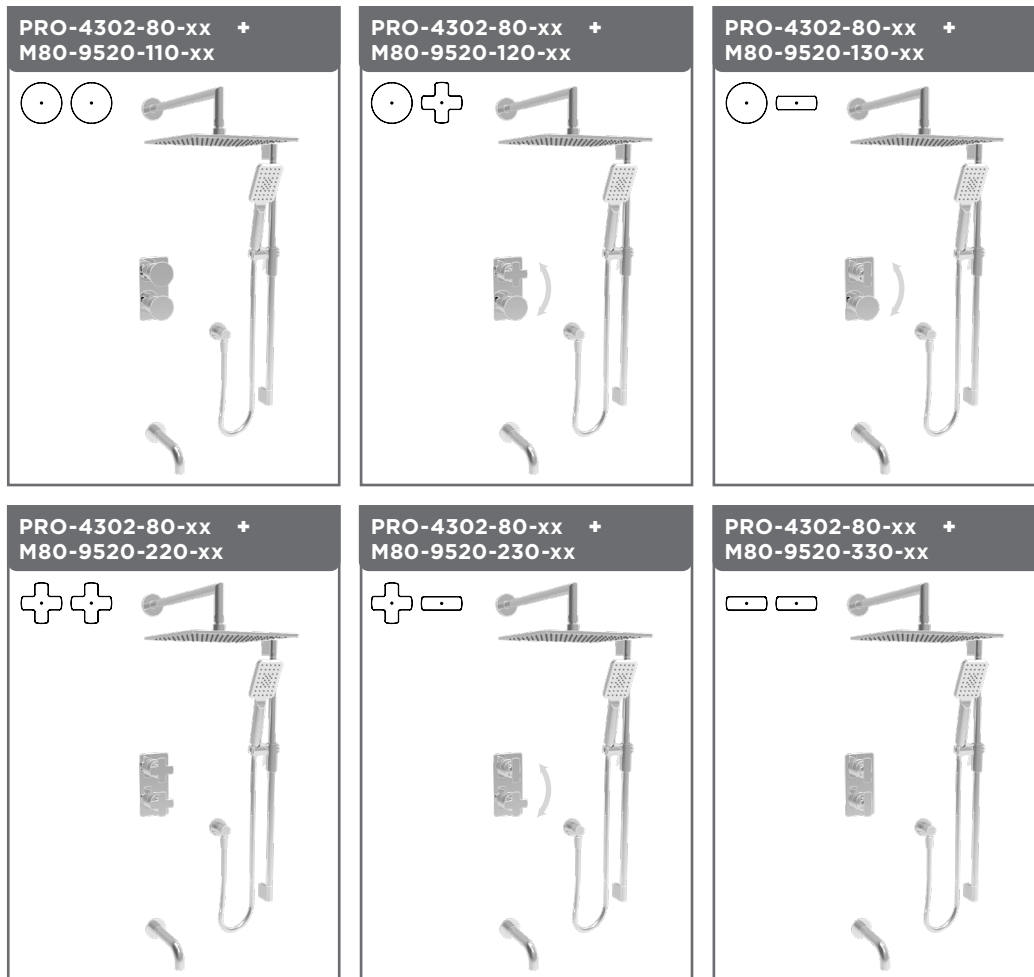

Finishes:

CC = chrome, KK = matte black, LL = satin brass, BB = white, NN = brushed nickel, YY = polished nickel, TT = venetian bronze, VV = satin copper, GG = gold

* With 6" ceiling mount shower arm

AIR B80

SELECTION OF BATHROOM ACCESSORIES

For more bathroom accessories, please refer to the bathroom accessories section (see p. 293-306).

A66-1029-01-xx

ZIP
Wall-mounted toilet paper holder



CC	KK	LL	BB	NN/YY	VV/TT	GG
197	256	296	296	256	315	433

A66-1069-01-xx

ZIP
Bathrobe holder



CC	KK	LL	BB	NN/YY	VV/TT	GG
99	129	149	149	129	158	218

A80-1069-00-xx

AIR
Bathrobe holder

Available Q3 2023



CC	KK	LL	BB	NN/YY	VV/TT	GG
225	293	338	338	293	360	495

A66-6018-00-xx

ZIP
18" single towel bar



CC	KK	LL	BB	NN/YY	VV/TT	GG
299	389	449	449	389	478	658

A66-6024-00-xx

ZIP
24" single towel bar



CC	KK	LL	BB	NN/YY	VV/TT	GG
323	420	485	485	420	517	711

A66-6030-00-xx

ZIP
30" single towel bar



CC	KK	LL	BB	NN/YY	VV/TT	GG
381	495	571	571	495	609	838

A66-6315-00-xx

ZIP
Triple towel bar

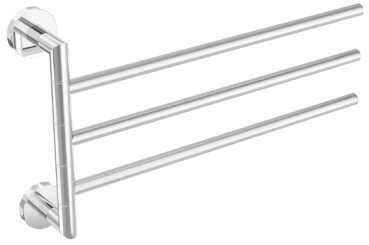

CC	KK	LL	BB	NN/YY	VV/TT	GG
399	519	599	599	519	638	878

A85-2009-40-xx

Towel holder on stand



CC
523

Actual products may differ from pictures. Actual products measures may differ from the measures shown. All USD prices are subject to change without notice. Effective as of August 2023.

ACCESSORIES



BARIL

ACCESSORIES

PETITE COLLECTION

A04-1029-00-xx

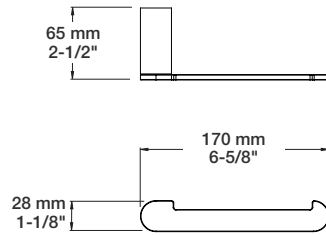

CC	KK	LL	BB	NN/YY	VV/TT	KM	GG
197	256	296	296	256	315	394	433

PETITE

Wall-mounted toilet paper holder

A04-1069-00-xx

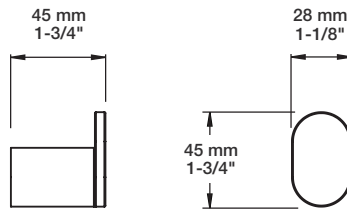

CC	KK	LL	BB	NN/YY	VV/TT	KM	GG
92	120	138	138	120	147	184	202

PETITE

Bathrobe holder

A04-6012-00-xx

Available Q3 2023

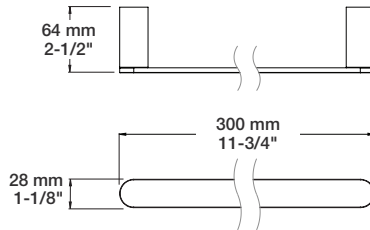

CC	KK	LL	BB	NN/YY	VV/TT	KM	GG
245	319	368	368	319	392	490	539

PETITE

12" single towel bar

A04-6018-00-xx

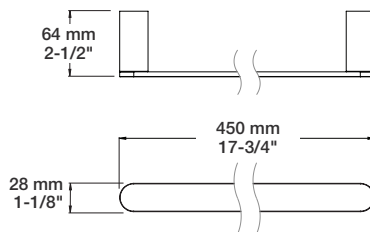

CC	KK	LL	BB	NN/YY	VV/TT	KM	GG
275	358	413	413	358	440	550	605

PETITE

18" single towel bar

A04-6024-00-xx

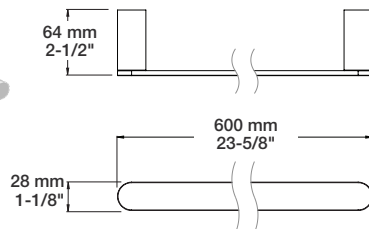

CC	KK	LL	BB	NN/YY	VV/TT	KM	GG
305	397	458	458	397	488	610	671

PETITE

24" single towel bar

Actual products may differ from pictures. Actual products measures may differ from the measures shown. All USD prices are subject to change without notice. Effective as of August 2023.

A04-6030-00-xx

CC	KK	LL	BB	NN/YY	VV/TT	KM	GG
385	501	578	578	501	616	770	847

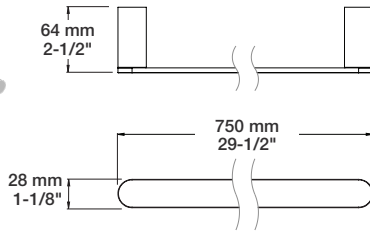

PETITE

30" single towel bar

Finishes:

CC = chrome, CF = smokey chrome, FR = frosted, KK = matte black, LL = satin brass, BB = white, KM = black titanium, NN = brushed nickel, YY = polished nickel, TT = venetian bronze, VV = satin copper, GG = gold

ACCESSORIES

FLAT COLLECTION

A44-1029-00-xx

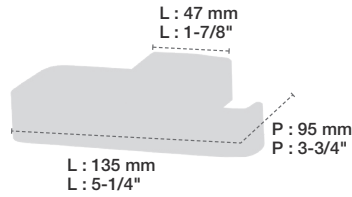

CC	KK	LL	BB	NN/YY	VV/TT	GG
144	187	216	216	187	230	317

FLAT

Square wall-mounted toilet paper holder

A44-1069-00-xx

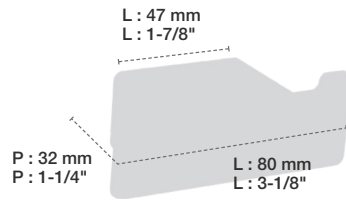

CC	KK	LL	BB	NN/YY	VV/TT	GG
90	117	135	135	117	144	198

FLAT

Square bathrobe holder

A44-6017-00-xx

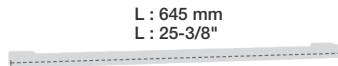

CC	KK	LL	BB	NN/YY	VV/TT	GG
248	323	372	372	323	397	546

FLAT

25" square single towel bar

A44-6027-00-xx

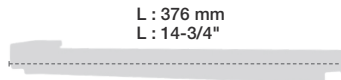

CC	KK	LL	BB	NN/YY	VV/TT	GG
298	387	447	447	387	477	656

FLAT

Square double towel bar
A- 2 pivoting bars with a single wall mount

Actual products may differ from pictures. Actual products measures may differ from the measures shown. All USD prices are subject to change without notice. Effective as of August 2023.

A46-1029-00-xx

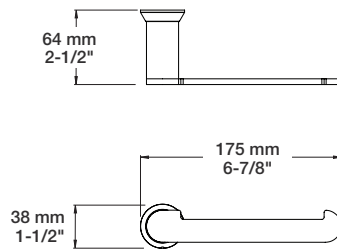

CC	CF	KK	LL	BB	NN/YY	VV/TT	GG
226	226	294	339	339	294	361	497

PROFILE

Wall-mounted toilet paper holder

A46-1069-00-xx

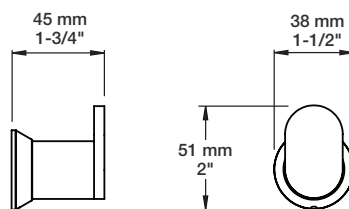

CC	CF	KK	LL	BB	NN/YY	VV/TT	GG
126	126	164	189	189	164	202	277

PROFILE

Bathrobe holder

A46-6012-00-xx

Available Q3 2023

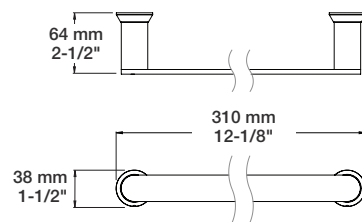

CC	CF	KK	LL	BB	NN/YY	VV/TT	GG
292	292	380	438	438	380	467	642

PROFILE

12" single towel bar

A46-6018-00-xx

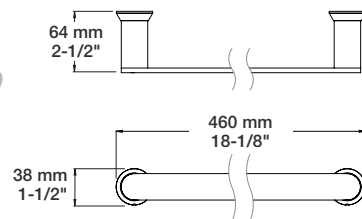

CC	CF	KK	LL	BB	NN/YY	VV/TT	GG
322	322	419	483	483	419	515	708

PROFILE

18" single towel bar

A46-6024-00-xx

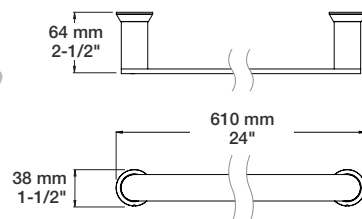

CC	CF	KK	LL	BB	NN/YY	VV/TT	GG
364	364	473	546	546	473	582	800

PROFILE

24" single towel bar

Finishes:

CC = chrome, CF = smokey chrome, FR = frosted, KK = matte black, LL = satin brass, BB = white, KM = black titanium, NN = brushed nickel, YY = polished nickel, TT = venetian bronze, VV = satin copper, GG = gold

ACCESSORIES

PROFILE + FLORA COLLECTION

A46-6030-00-xx

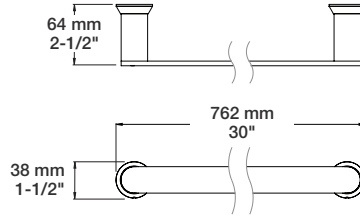

CC	CF	KK	LL	BB	NN/YY	VV/TT	GG
439	439	570	658	658	570	702	965

PROFILE

30" single towel bar

A47-1069-00-xx

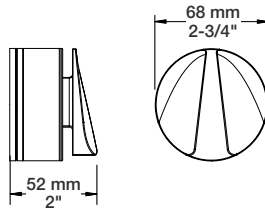

Cx	Kx	Lx	Bx	Nx/Yx	Vx/Tx	Gx
219	285	329	329	285	350	482

FLORA

Bathrobe holder

A- Double hook

Actual products may differ from pictures. Actual products measures may differ from the measures shown. All USD prices are subject to change without notice. Effective as of August 2023.

A56-1029-00-xx

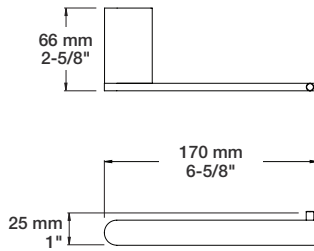

CC	KK	LL	BB	NN/YY	VV/TT	GG
226	294	339	339	294	361	497

ACCENT

Wall-mounted toilet paper holder

A56-1069-00-xx

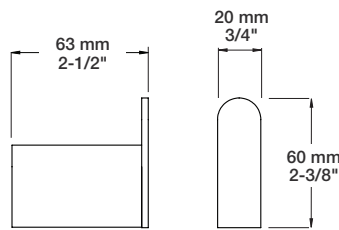

CC	KK	LL	BB	NN/YY	VV/TT	GG
116	151	174	174	151	186	255

ACCENT

Bathrobe holder

A56-6018-00-xx

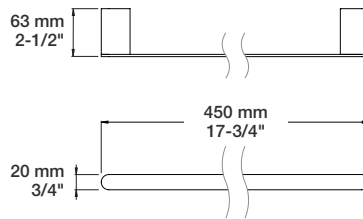

CC	KK	LL	BB	NN/YY	VV/TT	GG
292	380	438	438	380	467	642

ACCENT

18" single towel bar

A56-6024-00-xx

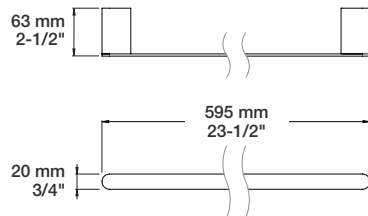

CC	KK	LL	BB	NN/YY	VV/TT	GG
340	442	510	510	442	544	748

ACCENT

24" single towel bar

A56-6028-00-xx

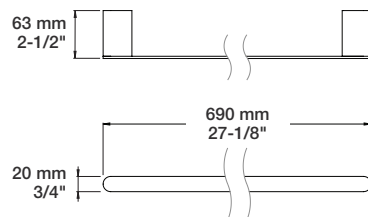

CC	KK	LL	BB	NN/YY	VV/TT	GG
410	533	615	615	533	656	902

ACCENT

28" single towel bar

Finishes:

CC = chrome, CF = smokey chrome, FR = frosted, KK = matte black, LL = satin brass, BB = white, KM = black titanium, NN = brushed nickel, YY = polished nickel, TT = venetian bronze, VV = satin copper, GG = gold

ACCESSORIES

ZIP + AIR COLLECTION

A66-1029-01-xx

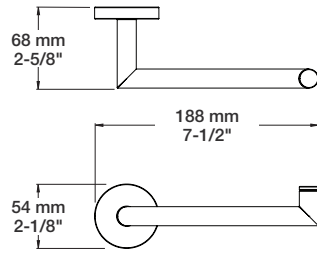
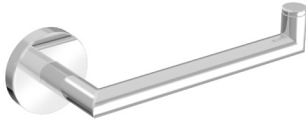

CC	KK	LL	BB	NN/YY	VV/TT	GG
197	256	296	296	256	315	433

ZIP

Wall-mounted toilet paper holder

A66-1069-01-xx

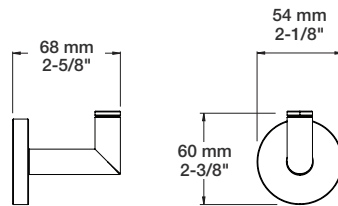

CC	KK	LL	BB	NN/YY	VV/TT	GG
99	129	149	149	129	158	218

ZIP

Bathrobe holder

A66-1079-00-xx

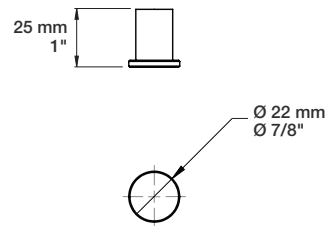

CC	KK	LL	BB	NN/YY	VV/TT	GG
79	103	119	119	103	126	174

ZIP

Bathrobe holder

A66-6018-00-xx

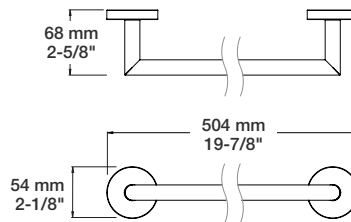
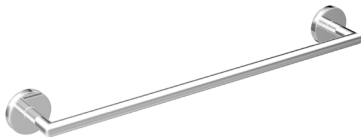

CC	KK	LL	BB	NN/YY	VV/TT	GG
299	389	449	449	389	478	658

ZIP

18" single towel bar

A66-6024-00-xx

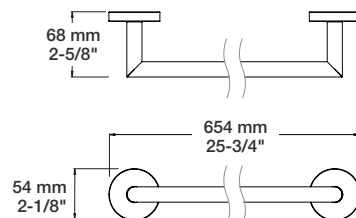
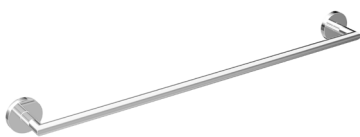

CC	KK	LL	BB	NN/YY	VV/TT	GG
323	420	485	485	420	517	711

ZIP

24" single towel bar

Actual products may differ from pictures. Actual products measures may differ from the measures shown. All USD prices are subject to change without notice. Effective as of August 2023.

A66-6030-00-xx

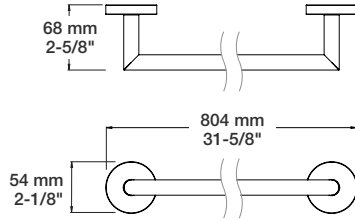

CC	KK	LL	BB	NN/YY	VV/TT	GG
381	495	571	571	495	609	838

ZIP

30" single towel bar

A66-6315-00-xx

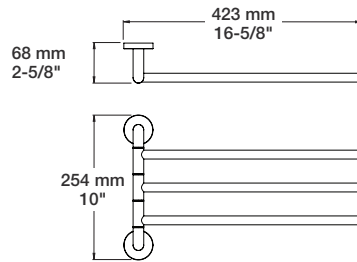
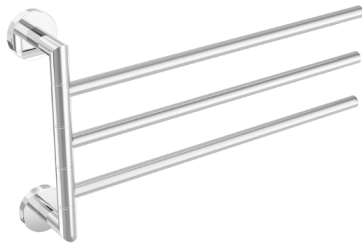

CC	KK	LL	BB	NN/YY	VV/TT	GG
399	519	599	599	519	638	878

ZIP

Triple towel bar
A- 180° swivel arms

A80-1069-00-xx

Available Q3 2023

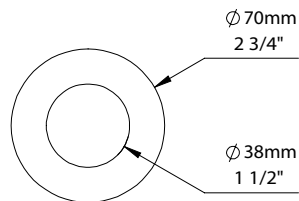

CC	KK	LL	BB	NN/YY	VV/TT	GG
225	293	338	338	293	360	495

AIR

Bathrobe holder

Finishes:

CC = chrome, CF = smokey chrome, FR = frosted, KK = matte black, LL = satin brass, BB = white, KM = black titanium, NN = brushed nickel, YY = polished nickel, TT = venetian bronze, VV = satin copper, GG = gold

ACCESSORIES

FLOW COLLECTION

A84-1069-00-xx

CC	KK	LL	BB	NN/YY	VV/TT	GG
132	172	198	198	172	211	290

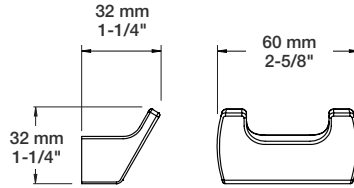

FLOW

Bathrobe holder

ACCESSORIES

A85-2009-40-CC

CC

523

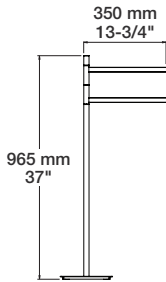

Towel holder on stand

A- 8-3/4" square base
B- 360° swivel arms

A85-2059-00-CC

CC

248

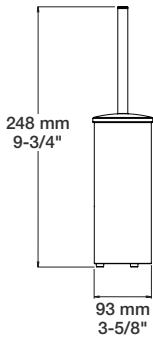

Round toilet brush

A- 2 installation options: freestanding or wall-mounted

A85-2059-40-CC

CC

298

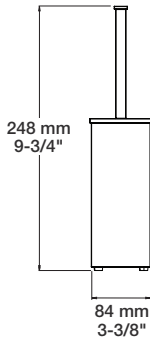

Square toilet brush

A- 2 installation options: freestanding or wall-mounted

A85-3179-00-CC

CC

173

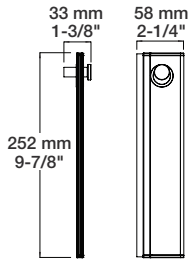

Shower squeegee

A- Wall support included

A85-3189-00-CC

CC

118

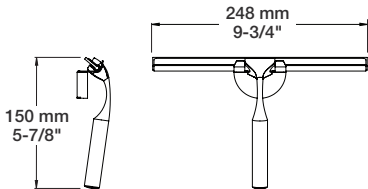

Shower squeegee

A- Wall support included

Finishes:

CC = chrome, CF = smokey chrome, FR = frosted, KK = matte black, LL = satin brass, BB = white, KM = black titanium, NN = brushed nickel, YY = polished nickel, TT = venetian bronze, VV = satin copper, GG = gold

ACCESSORIES

A85-9000-00-CC

CC

564

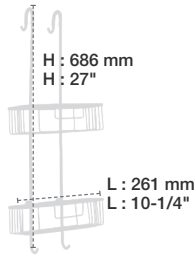

Shower hanging shelves

A- 2 baskets of 4" (10 cm) x 10" (25 cm)

A85-9019-00-CC

CC

121

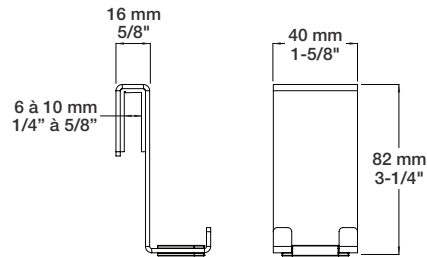

Shower hanging hook

A- Polished stainless steel
B- 3 adaptors for 6, 8 or 10 mm glass thickness included

A85-9077-00-CC

CC

248

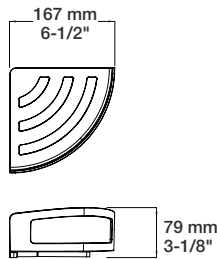

Corner basket

A- Polished stainless steel

A85-9088-00-CC

CC

298

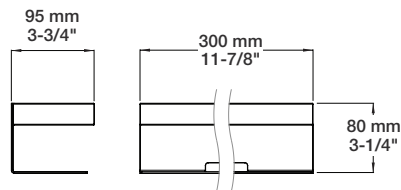
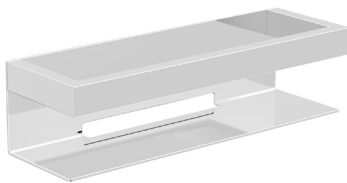

Wall basket

A- Polished stainless steel

Actual products may differ from pictures. Actual products measures may differ from the measures shown. All USD prices are subject to change without notice. Effective as of August 2023.

ACCESSORIES

A86-2019-00-FR

FR

58

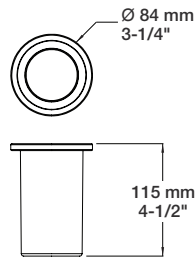

Toothbrush holder

A- Frosted surface
B- Freestanding or to hang on the wall-mounted accessory holder A86-6018-00-xx

A86-2029-00-FR

FR

58

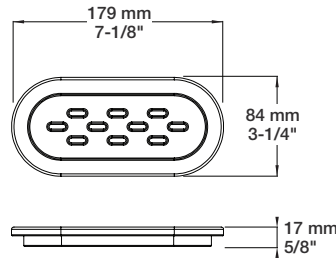

Soap dish

A- Frosted surface
B- Freestanding or to hang on the wall-mounted accessory holder A86-6018-00-xx

A86-2039-00-CC

CC

118

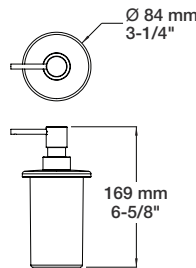

Soap dispenser

A- Frosted surface
B- Freestanding or to hang on the wall-mounted accessory holder A86-6018-00-xx

A86-6018-00-xx

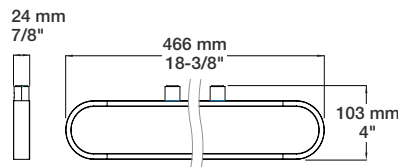
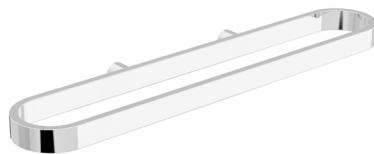

CC	KK	LL	BB	NN/YY	VV/TT	GG
498	647	747	747	647	797	1096

Wall-mounted towel and accessory holder

A- Horizontally: can be used to hang the accessories A86-2019-00-FR, A86-2029-00-FR and A86-2039-00-CC
B- Vertically: can be used as a rolled towel holder

Finishes:

CC = chrome, CF = smokey chrome, FR = frosted, KK = matte black, LL = satin brass, BB = white, KM = black titanium, NN = brushed nickel, YY = polished nickel, TT = venetian bronze, VV = satin copper, GG = gold

Parts

BARIL

PARTS

COL-3004-03-xx



CC	KK	LL	BB	NN/YY	VV/TT	GG
945	1229	1418	1418	1229	1512	2079

Pair of 30-1/4" freestanding pillar legs

A- 3/4" F / 3/4" M / 1/2" F / 1/2" M adapter
 B- Installs from the top for easy installation by one person

EXC-6014-02-xx



CC	KK	LL	BB	NN/YY	VV/TT	GG
170	221	255	255	221	272	374

Pair of 2-3/8" (60 mm) eccentric adapters

A- Can be used to install a wall-mounted tub faucet
 B- For holes from 2" c/c to 10" c/c

PLA-0423-01-xx



CC	KK	LL	BB	NN/YY	VV/TT	GG
65	85	98	98	85	104	143

Single hole lavatory faucet plate

PLA-0430-00-xx

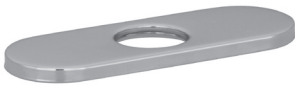

CC	KK	LL	BB	NN/YY	VV/TT	KM	GG
65	85	98	98	85	104	104	143

Single hole lavatory faucet oblong plate

PLA-0440-00-xx



CC	KK	LL	BB	NN/YY	VV/TT	GG
65	85	98	98	85	104	143

Single hole lavatory faucet rectangular plate

Actual products may differ from pictures. Actual products measures may differ from the measures shown. All USD prices are subject to change without notice. Effective as of August 2023.

REN-0020-01-xx



CC	KK	LL	BB	NN/YY	VV/TT	GG
90	117	135	135	117	144	198

Automatic pop-up drain
A- Brass construction

REN-2007-10-xx



CC	KK	LL	BB	NN/YY	VV/TT	GG
404	526	607	607	526	647	890

Turn control cable-operated brass bath waste and overflow drain

- A- Flexible brass tube conforms to any bath model
- B- Fits most tubs from 17" to 24" (43 to 61 cm) deep
- C- Function to prevent unwanted cap closure
- D- Non-water contact cable operation
- E- For tub thicknesses from 1/32" to 7/16" (1 to 11 mm)

REN-2008-14-xx



CC	KK	LL	BB	NN/YY	VV/TT	KM	GG
404	526	607	607	526	647	647	890

20" brass push-button waste and overflow drain

- A- Flexible brass tube to fit different baths
- B- Fits most tubs from 17" to 24" (43 to 61 cm) deep
- C- For tub thicknesses from 1/32" to 7/16" (1 to 11 mm)
- D- Push-button mechanism

REN-2018-27-xx



CC	KK	LL	BB	NN/YY	VV/TT	GG
584	759	876	876	759	934	1285

Brass bath waste and overflow drain

- A- Fits most tubs from 17" to 24" (43 to 61 cm) deep
- B- Push-button pop-up mechanism

REN-8402-02-xx



CC
120

Push-button pop-up drain for lavatory with overflow

- A- For lavatory with overflow (P.O. plug)
- B- Decorative cap diameter: 2-1/8" (55 mm)

Finishes:

CC = chrome, KK = matte black, LL = satin brass, BB = white, KM = black titanium, NN = brushed nickel, YY = polished nickel, TT = venetian bronze, VV = satin copper, II = mist, JJ = french gold, GG = gold

PARTS

REN-8403-02-xx

CC

120



Push-button pop-up drain for lavatory without overflow

A- For lavatory without overflow (C.O. plug)
B- Decorative cap diameter: 2-1/8" (55 mm)

REN-8416-02-xx

CC

81



Grid lavatory drain with overflow

A- For lavatory with overflow (P.O. plug)

REN-8417-02-xx

CC

75



Grid lavatory drain without overflow

A- For lavatory without overflow (C.O. plug)

— THE ESSENTIALS —

REN-8422-02-xx

CC	KK	LL	BB	NN/YY	VV/TT	KM	II	JJ	GG
144	188	217	217	188	231	231	222	222	332



Push-button lavatory brass pop-up drain (with overflow)

A- For lavatory with overflow (P.O. plug)
B- Decorative cap diameter: 2-5/8" (66 mm)
C- Easy-to-clean removable drain cap

— THE ESSENTIALS —

REN-8423-02-xx

CC	KK	LL	BB	NN/YY	VV/TT	KM	II	JJ	GG
144	188	217	217	188	231	231	222	222	332



Push-button lavatory brass pop-up drain (without overflow)

A- For lavatory without overflow (C.O. plug)
B- Decorative cap diameter: 2-5/8" (66 mm)
C- Easy-to-clean removable drain cap

Actual products may differ from pictures. Actual products measures may differ from the measures shown. All USD prices are subject to change without notice. Effective as of August 2023.

REN-8800-00-xx

CC	KK	LL	BB	NN/YY	VV/TT	KM	GG
318	413	477	477	413	508	508	731



Round decorative bottle trap

Finishes:

CC = chrome, KK = matte black, LL = satin brass, BB = white, KM = black titanium, NN = brushed nickel, YY = polished nickel, TT = venetian bronze, VV = satin copper, II = mist, JJ = french gold, GG = gold

Showers

BARIL

Shower Valves

BARIL

RVA-9020-X0-B

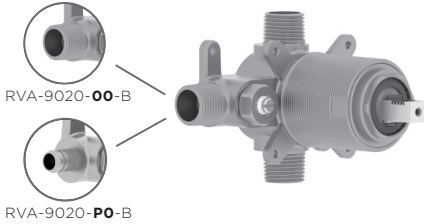

Pressure balanced rough

- A- 6 gpm - 60 psi
- B- Volume control valve
- C- Separate volume control NOT required
- D- Built-in check / non-return valves
- E- CAR-1020-40

RVA-9020-00-B

Type P rough - 1/2" male NPT or welded copper connections

310

RVA-9020-P0-B

Type P rough - PEX connections

310

B04-9100-00-xx

PETITE



ROUGH & TRIM PACKAGE

CC	KK	LL	BB
645	746	813	813

TRIM ONLY

T04-9139-00-xx

CC	KK	LL	BB
335	436	503	503

B05-9100-00-xx

REC



ROUGH & TRIM PACKAGE

CC	KK	LL	BB
660	765	835	835

TRIM ONLY

T05-9139-01-xx

CC	KK	LL	BB
350	455	525	525

B45-9100-00-xx

SENS



ROUGH & TRIM PACKAGE

CC	KK	LL	BB
635	733	798	798

TRIM ONLY

T45-9139-01-xx

CC	KK	LL	BB
325	423	488	488

B46-9100-00-xx

PROFILE



ROUGH & TRIM PACKAGE

CC	KK	LL	BB
645	746	813	813

TRIM ONLY

T46-9139-00-xx

CC	KK	LL	BB
335	436	503	503

B66-9120-00-xx

ZIP



ROUGH & TRIM PACKAGE

CC	KK	LL	BB
539	608	654	654

TRIM ONLY

T66-9139-00-xx

CC	KK	LL	BB
229	298	344	344

B80-9101-00-xx

AIR

Available Q3 2023



VALVE WITHOUT HANDLE

CC	KK	LL	BB
522	586	628	628

TRIM (WITHOUT HANDLE)

T80-9101-00-xx

CC	KK	LL	BB
212	276	318	318

B80-9102-00-xx

AIR

Available Q3 2023



VALVE WITHOUT HANDLE

CC	KK	LL	BB
522	586	628	628

TRIM (WITHOUT HANDLE)

T80-9102-00-xx

CC	KK	LL	BB
212	276	318	318

Finishes:

CC = chrome, CD = chrome diamond, CF = smokey chrome, KK = matte black, LL = satin brass, BB = white, NN = brushed nickel, YY = polished nickel, TT = venetian bronze, VV = satin copper, GG = gold, KM = black titanium, CB = chrome white, KB = matte black white, LB = satin brass white, NB = brushed nickel white, YB = polished nickel white, TB = venetian bronze, VB = satin copper white, GB = gold white

SHOWER VALVES

PRESSURE BALANCED WITH 2-WAY DIVERTER

RVA-9181-XO-B

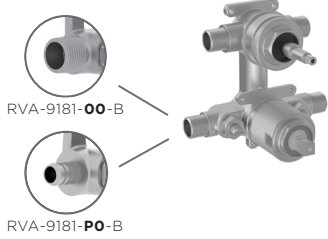

Pressure balanced rough with 2-way diverter (shared port)

- A- 1 outlet: 5 gpm - 60 psi
- A- 2 outlets: 2.6 gpm - 60 psi
- B- Volume control valve
- C- Separate volume control NOT required
- D- 2-way diverter with shared port
- E- Built-in check / non-return valves
- F- CAR-1020-40 (volume)
CAR-1001-35 (diverter)

RVA-9181-00-B

2-way type P rough (shared port) - 1/2" male NPT or welded copper connections

474

RVA-9181-PO-B

2-way type P rough (shared port) - PEX connections

474

B04-9180-00-xx

PETITE



ROUGH & TRIM PACKAGE

CC	KK	LL	BB
841	951	1025	1025

TRIM ONLY

T04-9180-00-xx

CC	KK	LL	BB
367	477	551	551

B05-9181-00-xx

REC



ROUGH & TRIM PACKAGE

CC	KK	LL	BB
917	1050	1139	1139

TRIM ONLY

T05-9181-00-xx

CC	KK	LL	BB
443	576	665	665

B14-9180-00-xx

OVAL



ROUGH & TRIM PACKAGE

CC	KK	LL	BB
994	1150	1254	1254

TRIM ONLY

T14-9180-00-xx

CC	KK	LL	BB
520	676	780	780

B45-9180-00-xx

SENS



ROUGH & TRIM PACKAGE

CC	KK	LL	BB
822	926	996	996

TRIM ONLY

T45-9180-01-xx

CC	KK	LL	BB
348	452	522	522

B46-9180-00-xx

PROFILE



ROUGH & TRIM PACKAGE

CC	KK	LL	BB
841	951	1025	1025

TRIM ONLY

T46-9180-00-xx

CC	KK	LL	BB
367	477	551	551

B66-9181-00-xx

ZIP



ROUGH & TRIM PACKAGE

CC	KK	LL	BB
773	863	923	923

TRIM ONLY

T66-9181-00-xx

CC	KK	LL	BB
299	389	449	449

B80-9181-00-xx

AIR

Available Q3 2023



VALVE WITHOUT HANDLE

CC	KK	LL	BB
749	832	887	887

TRIM (WITHOUT HANDLE)

T80-9181-00-xx

CC	KK	LL	BB
275	358	413	413

B80-9182-00-xx

AIR

Available Q3 2023



VALVE WITHOUT HANDLE

CC	KK	LL	BB
749	832	887	887

TRIM (WITHOUT HANDLE)

T80-9182-00-xx

CC	KK	LL	BB
275	358	413	413

Actual products may differ from pictures. Actual products measures may differ from the measures shown. All USD prices are subject to change without notice. Effective as of August 2023.

RVA-9181-XO-NS-B

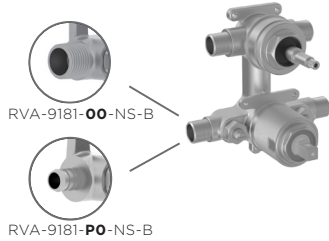

Pressure balanced rough with 2-way diverter (non-shared port)

- A- 5 gpm - 60 psi
- B- Volume control valve
- C- Separate volume control NOT required
- D- 2-way diverter with non-shared port
- E- Built-in check / non-return valves
- F- CAR-1020-40 (volume)
CAR-1001-35-NS (diverter)

RVA-9181-00-NS-B 2-way type P rough (non-shared port) - 1/2" male NPT or welded copper connections

474

RVA-9181-PO-NS-B 2-way type P rough (non-shared port) - PEX connections

474

B04-9180-00-xx-NS

PETITE

ROUGH & TRIM PACKAGE

CC	KK	LL	BB
841	951	1025	1025

TRIM ONLY

T04-9180-00-xx

CC	KK	LL	BB
367	477	551	551

B05-9181-00-xx-NS

REC

ROUGH & TRIM PACKAGE

CC	KK	LL	BB
917	1050	1139	1139

TRIM ONLY

T05-9181-00-xx

CC	KK	LL	BB
443	576	665	665

B14-9180-00-xx-NS

OVAL

ROUGH & TRIM PACKAGE

CC	KK	LL	BB
994	1150	1254	1254

TRIM ONLY

T14-9180-00-xx

CC	KK	LL	BB
520	676	780	780

B45-9180-00-xx-NS

SENS

ROUGH & TRIM PACKAGE

CC	KK	LL	BB
822	926	996	996

TRIM ONLY

T45-9180-01-xx

CC	KK	LL	BB
348	452	522	522

B46-9180-00-xx-NS

PROFILE

ROUGH & TRIM PACKAGE

CC	KK	LL	BB
841	951	1025	1025

TRIM ONLY

T46-9180-00-xx

CC	KK	LL	BB
367	477	551	551

B66-9181-00-xx-NS

ZIP

ROUGH & TRIM PACKAGE

CC	KK	LL	BB
773	863	923	923

TRIM ONLY

T66-9181-00-xx

CC	KK	LL	BB
299	389	449	449

B80-9181-00-xx-NS

AIR

Available Q3 2023

VALVE WITHOUT HANDLE

CC	KK	LL	BB
749	832	887	887

TRIM (WITHOUT HANDLE)

T80-9181-00-xx

CC	KK	LL	BB
275	358	413	413

B80-9182-00-xx-NS

AIR

Available Q3 2023

VALVE WITHOUT HANDLE

CC	KK	LL	BB
749	832	887	887

TRIM (WITHOUT HANDLE)

T80-9182-00-xx

CC	KK	LL	BB
275	358	413	413

Finishes:

CC = chrome, CD = chrome diamond, CF = smokey chrome, KK = matte black, LL = satin brass, BB = white, NN = brushed nickel, YY = polished nickel, TT = venetian bronze, VV = satin copper, GG = gold, KM = black titanium, CB = chrome white, KB = matte black white, LB = satin brass white, NB = brushed nickel white, YB = polished nickel white, TB = venetian bronze, VB = satin copper white, GB = gold white

SHOWER VALVES

PRESSURE BALANCED WITH 3-WAY DIVERTER

RVA-9191-X0-B

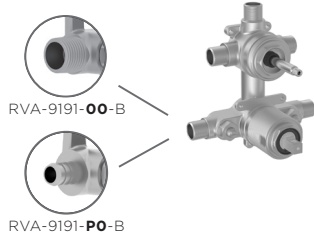

Pressure balanced rough with 3-way diverter (shared port)

- A- 1 outlet: 5 gpm - 60 psi
- A- 2 outlets: 2.6 gpm - 60 psi
- B- Volume control valve
- C- Separate volume control NOT required
- D- 3-way diverter with shared port
- E- Built-in check / non-return valves
- F- CAR-1020-40 (volume)
CAR-9220-02 (diverter)

RVA-9191-00-B

3-way type P rough (shared port) - 1/2" male NPT or welded copper connections

529

RVA-9191-P0-B

3-way type P rough (shared port) - PEX connections

529

B04-9190-00-xx

PETITE



ROUGH & TRIM PACKAGE

CC	KK	LL	BB
896	1006	1080	1080

TRIM ONLY

T04-9190-00-xx

CC	KK	LL	BB
367	477	551	551

B45-9190-00-xx

SENS



ROUGH & TRIM PACKAGE

CC	KK	LL	BB
877	981	1051	1051

TRIM ONLY

T45-9190-01-xx

CC	KK	LL	BB
348	452	522	522

B66-9190-00-xx

ZIP



ROUGH & TRIM PACKAGE

CC	KK	LL	BB
828	918	978	978

TRIM ONLY

T66-9190-00-xx

CC	KK	LL	BB
299	389	449	449

B80-9191-00-xx

AIR

Available Q3 2023



VALVE WITHOUT HANDLE

CC	KK	LL	BB
804	887	942	942

TRIM (WITHOUT HANDLE)

T80-9191-00-xx

CC	KK	LL	BB
275	358	413	413

B80-9192-00-xx

AIR

Available Q3 2023



VALVE WITHOUT HANDLE

CC	KK	LL	BB
804	887	942	942

TRIM (WITHOUT HANDLE)

T80-9192-00-xx

CC	KK	LL	BB
275	358	413	413

Actual products may differ from pictures. Actual products measures may differ from the measures shown. All USD prices are subject to change without notice. Effective as of August 2023.

RVA-9191-XO-NS-B

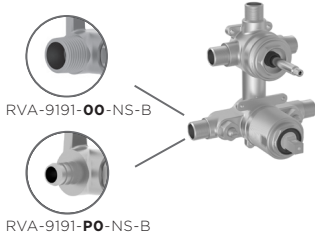

Pressure balanced rough with 3-way diverter (non-shared port)

- A- 5 gpm - 60 psi
- B- Volume control valve
- C- Separate volume control NOT required
- D- 3-way diverter with non-shared position
- E- Built-in check / non-return valves
- F- CAR-1020-40 (volume)
CAR-9220-02-NS (diverter)

RVA-9191-00-NS-B	3-way type P rough (non-shared port) - 1/2" male NPT or welded copper connections	529
-------------------------	-----------------------------------------------------------------------------------	------------

RVA-9191-P0-NS-B	3-way type P rough (non-shared port) - PEX connections	529
-------------------------	--------------------------------------------------------	------------

B04-9190-00-xx-NS

PETITE

ROUGH & TRIM PACKAGE

CC	KK	LL	BB
896	1006	1080	1080

TRIM ONLY

T04-9190-00-xx

CC	KK	LL	BB
367	477	551	551

B45-9190-00-xx-NS

SENS

ROUGH & TRIM PACKAGE

CC	KK	LL	BB
877	981	1051	1051

TRIM ONLY

T66-9190-00-xx

CC	KK	LL	BB
348	452	522	522

B66-9190-00-xx-NS

ZIP

ROUGH & TRIM PACKAGE

CC	KK	LL	BB
828	918	978	978

TRIM ONLY

T95-9190-00-xx

CC	KK	LL	BB
299	389	449	449

B80-9191-00-xx-NS

AIR

Available Q3 2023

VALVE WITHOUT HANDLE

CC	KK	LL	BB
804	887	942	942

TRIM (WITHOUT HANDLE)

T80-9191-00-xx

CC	KK	LL	BB
275	358	413	413

B80-9192-00-xx-NS

AIR

Available Q3 2023

VALVE WITHOUT HANDLE

CC	KK	LL	BB
804	887	942	942

TRIM (WITHOUT HANDLE)

T80-9192-00-xx

CC	KK	LL	BB
275	358	413	413

Finishes:

CC = chrome, CD = chrome diamond, CF = smokey chrome, KK = matte black, LL = satin brass, BB = white, NN = brushed nickel, YY = polished nickel, TT = venetian bronze, VV = satin copper, GG = gold, KM = black titanium, CB = chrome white, KB = matte black white, LB = satin brass white, NB = brushed nickel white, YB = polished nickel white, TB = venetian bronze, VB = satin copper white, GB = gold white

SHOWER VALVES

3/4" THERMOSTATIC

RVA-3404-00-B

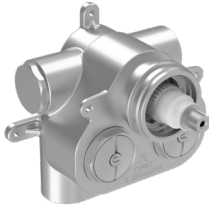

3/4" thermostatic rough valve

- A- 16 gpm - 60 psi
- B- Separate shut-offs or diverter required
- C- Can easily supply 3 accessories
- D- Built-in stop check valves
- E- CAR-3404-00
- F- 3/4" female NPT connections
- G- Reversible check / non-return valves in case of water supply inversion
- H- 1-3/8" decorative extension for thick wall or to correct deep rough-ins: order EXT-3404-00-xx

RVA-3404-00-B

Type T rough - 3/4" female NPT connections

682

B04-9404-00-xx

PETITE

ROUGH & TRIM PACKAGE

CC	KK	LL	BB
1199	1354	1458	1458

TRIM ONLY

T04-9404-00-xx

CC	KK	LL	BB
517	672	776	776

B05-9404-00-xx

REC

ROUGH & TRIM PACKAGE

CC	KK	LL	BB
1243	1411	1523	1523

TRIM ONLY

T05-9404-00-xx

CC	KK	LL	BB
561	729	841	841

B16-9404-00-xx

NAUTICA

ROUGH & TRIM PACKAGE

CC	KK	LL	BB
1243	1411	1524	1524

TRIM ONLY

T16-9404-00-xx

CC	KK	LL	BB
561	729	842	842

B18-9404-00-xx

RALPH

ROUGH & TRIM PACKAGE

CC/CB	KK/KB	LL/LB	BB
1243	1411	1524	1524

TRIM ONLY

T18-9404-00-xx

CC/CB	KK/KB	LL/LB	BB
561	729	842	842

B26-9404-00-xx

HAÜS-D

ROUGH & TRIM PACKAGE

CD
1681

TRIM ONLY

T26-9404-00-xx

CD
999

B27-9404-00-xx

HAÜS-C

ROUGH & TRIM PACKAGE

CC	KK	LL	BB
1370	1576	1714	1714

TRIM ONLY

T27-9404-00-xx

CC	KK	LL	BB
688	894	1032	1032

B28-9404-00-xx

HAÜS-L

ROUGH & TRIM PACKAGE

CC	KK	LL	BB
1370	1576	1714	1714

TRIM ONLY

T28-9404-00-xx

CC	KK	LL	BB
688	894	1032	1032

B45-9404-00-xx

SENS

ROUGH & TRIM PACKAGE

CC	KK	LL	BB
1179	1328	1428	1428

TRIM ONLY

T45-9404-00-xx

CC	KK	LL	BB
497	646	746	746

B46-9404-00-xx

PROFILE

ROUGH & TRIM PACKAGE

CC	KK	LL	BB
1199	1354	1458	1458

TRIM ONLY

T46-9404-00-xx

CC	KK	LL	BB
517	672	776	776

B56-9404-00-xx

ACCENT

ROUGH & TRIM PACKAGE

CC	CB	CF
1323	1323	1323

TRIM ONLY

T56-9404-00-xx

CC	CB	CF
641	641	641

B66-9404-00-xx

ZIP

ROUGH & TRIM PACKAGE

CC	KK	LL	BB
1127	1261	1350	1350

TRIM ONLY

T66-9404-00-xx

CC	KK	LL	BB
445	579	668	668

B71-9404-00-xx

EVA

ROUGH & TRIM PACKAGE

CC	KK	LL	BB
1243	1411	1524	1524

TRIM ONLY

T71-9404-00-xx

CC	KK	LL	BB
561	729	842	842

B72-9404-00-xx

TRADITION

ROUGH & TRIM PACKAGE

CC	KK	LL	BB
1243	1411	1524	1524

TRIM ONLY

T72-9404-00-xx

CC	KK	LL	BB
561	729	842	842

B74-9404-00-xx

VICTOIRE

ROUGH & TRIM PACKAGE

CB	KB	LB	BB
1243	1411	1524	1524

TRIM ONLY

T74-9404-00-xx

CB	KB	LB	BB
561	729	842	842

B80-9401-00-xx

AIR

Available Q3 2023

VALVE WITHOUT HANDLE

CC	KK	LL	BB
1107	1235	1320	1320

TRIM ONLY

T80-9401-00-xx

CC	KK	LL	BB
425	553	638	638

Actual products may differ from pictures. Actual products measures may differ from the measures shown. All USD prices are subject to change without notice. Effective as of August 2023.

RVA-3404-00-B

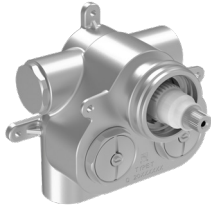

3/4" thermostatic rough valve

- A- 16 gpm - 60 psi
- B- Separate shut-offs or diverter required
- C- Can easily supply 3 accessories
- D- Built-in stop check valves
- E- CAR-3404-00
- F- 3/4" female NPT connections
- G- Reversible check / non-return valves in case of water supply inversion
- H- 1-3/8" decorative extension for thick wall or to correct deep rough-ins: order EXT-3404-00-xx

RVA-3404-00-B

Type T rough - 3/4" female NPT connections

682

B80-9402-00-xx

AIR

Available
Q3 2023



TRIM (WITHOUT HANDLE)

CC	KK	LL	BB
1107	1235	1320	1320

TRIM ONLY

T80-9402-00-xx

CC	KK	LL	BB
425	553	638	638

Finishes:

CC = chrome, CD = chrome diamond, CF = smokey chrome, KK = matte black, LL = satin brass, BB = white, NN = brushed nickel, YY = polished nickel, TT = venetian bronze, VV = satin copper, GG = gold, KM = black titanium, CB = chrome white, KB = matte black white, LB = satin brass white, NB = brushed nickel white, YB = polished nickel white, TB = venetian bronze, VB = satin copper white, GB = gold white

SHOWER VALVES

3/4" THERMOSTATIC

RVA-34B2-00-B

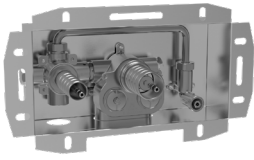

2-way 3/4" thermostatic rough (shared port)

- A- 8 gpm - 60 psi
- B- Easy to install one-piece rough with stainless steel case
- C- 2-way diverter with non-shared port
- D- CAR-3404-00 (temperature)
CAR-9530-03 (diverter)

RVA-34B2-00-B

Type T rough with 2-way diverter - inlet: 3/4" F NPT - outlets: 1/2" F NPT

1725

B35-9320-00-xx

MARIE



ROUGH & TRIM PACKAGE

All finishes

4335

TRIM ONLY

T35-9320-00-xx

All finishes

2610

Actual products may differ from pictures. Actual products measures may differ from the measures shown. All USD prices are subject to change without notice. Effective as of August 2023.

RVA-3453-00-B

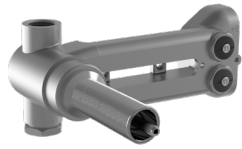

3/4" thermostatic rough valve

- A- 9 gpm - 60 psi
- B- Separate volume control or diverter valve required
- C- Can easily supply 3 accessories
- D- Reversible check / non-return valves in case of water supply inversion
- E- CAR-2661-00
- F- 3/4" female NPT connections

RVA-3453-00-B

Type T rough - 3/4" female NPT connections

649

B04-9453-00-xx

PETITE

ROUGH & TRIM PACKAGE

CC	KK	LL	BB
1166	1321	1425	1425

TRIM ONLY

T04-9453-00-xx

CC	KK	LL	BB
517	672	776	776

B45-9453-00-xx

SENS

ROUGH & TRIM PACKAGE

CC	KK	LL	BB
1146	1295	1395	1395

TRIM ONLY

T45-9453-00-xx

CC	KK	LL	BB
497	646	746	746

B46-9453-00-xx

PROFILE

ROUGH & TRIM PACKAGE

CC	KK	LL	BB
1166	1321	1425	1425

TRIM ONLY

T46-9453-00-xx

CC	KK	LL	BB
517	672	776	776

B47-9453-00-xx

FLORA

ROUGH & TRIM PACKAGE

Cx	Kx	Lx	Bx
1248	1428	1548	1548

TRIM ONLY

T47-9453-00-xx

Cx	Kx	Lx	Bx
599	779	899	899

B66-9453-00-xx

ZIP

ROUGH & TRIM PACKAGE

CC	KK	LL	BB
1094	1228	1317	1317

TRIM ONLY

T66-9453-00-xx

CC	KK	LL	BB
445	579	668	668

B80-9453-00-xx

AIR

Available Q3 2023

VALVE WITHOUT HANDLE

CC	KK	LL	BB
1074	1202	1287	1287

TRIM (WITHOUT HANDLE)

T80-9453-00-xx

CC	KK	LL	BB
425	553	638	638

Finishes:

CC = chrome, CD = chrome diamond, CF = smokey chrome, KK = matte black, LL = satin brass, BB = white, NN = brushed nickel, YY = polished nickel, TT = venetian bronze, VV = satin copper, GG = gold, KM = black titanium, CB = chrome white, KB = matte black white, LB = satin brass white, NB = brushed nickel white, YB = polished nickel white, TB = venetian bronze, VB = satin copper white, GB = gold white

SHOWER VALVES

2-WAY THERMOSTATIC PRESSURE BALANCED

RVA-9521-X0-B

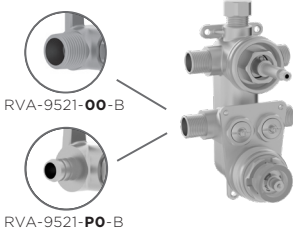

2-way thermostatic pressure balanced rough (shared port)

- A- 1 outlet: 7.9 gpm - 60 psi, 2 outlets: 3.7 gpm - 60 psi
- B- The best solution to minimize temperature fluctuations
- C- 2-way diverter with shared port
- D- Reversible check / non-return valves in case of water supply inversion
- E- CAR-2661-00 (temperature), CAR-3003-36 (diverter)
- F- Large depth adjustment range
- G- 1-3/8" decorative extension for thick wall or to correct deep rough-ins: order EXT-9520-30-xx

RVA-9521-00-B

2-way type TP rough (shared port) - 1/2" male NPT or welded copper connections

685

RVA-9521-P0-B

2-way type TP rough (shared port) - PEX connections

685

B04-9521-00-xx

PETITE



ROUGH & TRIM PACKAGE

CC	KK	LL	BB
1118	1248	1335	1335

TRIM ONLY

T04-9521-00-xx

CC	KK	LL	BB
433	563	650	650

B05-9521-00-xx

REC



ROUGH & TRIM PACKAGE

CC	KK	LL	BB
1153	1293	1387	1387

TRIM ONLY

T05-9521-00-xx

CC	KK	LL	BB
468	608	702	702

B35-9521-00-xx

MARIE



ROUGH & TRIM PACKAGE

Plate - CC	Plate - Others
1731	1948

TRIM ONLY

T35-9521-00-xx

Plate - CC	Plate - Others
1046	1263

B45-9521-00-xx

SENS



ROUGH & TRIM PACKAGE

CC	KK	LL	BB
1081	1200	1279	1279

TRIM ONLY

T45-9521-00-xx

CC	KK	LL	BB
396	515	594	594

B46-9521-00-xx

PROFILE



ROUGH & TRIM PACKAGE

CC	KK	LL	BB
1118	1248	1335	1335

TRIM ONLY

T46-9521-00-xx

CC	KK	LL	BB
433	563	650	650

B51-9521-00-xx

MA



ROUGH & TRIM PACKAGE

CC	CF	KK	BB
1303	1303	1489	1613

TRIM ONLY

T51-9521-00-xx

CC	CF	KK	BB
618	618	804	928

B56-9521-00-xx

ACCENT



ROUGH & TRIM PACKAGE

CC	CB	CF
1303	1303	1303

TRIM ONLY

T56-9521-00-xx

CC	CB	CF
618	618	618

B66-9521-00-xx

ZIP



ROUGH & TRIM PACKAGE

CC	KK	LL	BB
1069	1184	1261	1261

TRIM ONLY

T66-9521-00-xx

CC	KK	LL	BB
384	499	576	576

B80-9521-00-xx

AIR

Available Q3 2023



VALVE WITHOUT HANDLE

CC	KK	LL	BB
1050	1160	1233	1233

TRIM (WITHOUT HANDLE)

T80-9521-00-xx

CC	KK	LL	BB
365	475	548	548

B80-9522-00-xx

AIR

Available Q3 2023



VALVE WITHOUT HANDLE

CC	KK	LL	BB
1050	1160	1233	1233

TRIM (WITHOUT HANDLE)

T80-9522-00-xx

CC	KK	LL	BB
365	475	548	548

Actual products may differ from pictures. Actual products measures may differ from the measures shown. All USD prices are subject to change without notice. Effective as of August 2023.

RVA-9521-XO-NS-B

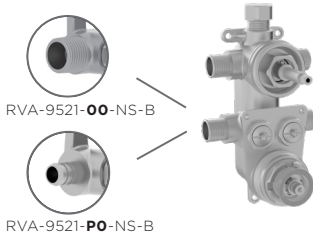

2-way thermostatic pressure balanced rough (non-shared port)

- A- 7.9 gpm - 60 psi
- B- The best solution to minimize temperature fluctuations
- C- 2-way diverter with non-shared port
- D- Reversible check / non-return valves in case of water supply inversion
- E- CAR-2661-00 (temperature), CAR-3003-36-NS (diverter)
- F- Large depth adjustment range
- G- 1-3/8" decorative extension for thick wall or to correct deep rough-ins: order EXT-9520-30-xx

RVA-9521-00-NS-B

2-way type TP rough (non-shared port) - 1/2" male NPT or welded copper connections

685

RVA-9521-PO-NS-B

2-way type TP rough (non-shared port) - PEX connections

685

<p>B04-9521-00-xx-NS</p> <p>PETITE</p> <p>ROUGH & TRIM PACKAGE</p> <table border="1"> <thead> <tr> <th>CC</th> <th>KK</th> <th>LL</th> <th>BB</th> </tr> </thead> <tbody> <tr> <td>1118</td> <td>1248</td> <td>1335</td> <td>1335</td> </tr> </tbody> </table> <p>TRIM ONLY</p> <p>T04-9521-00-xx</p> <table border="1"> <thead> <tr> <th>CC</th> <th>KK</th> <th>LL</th> <th>BB</th> </tr> </thead> <tbody> <tr> <td>433</td> <td>563</td> <td>650</td> <td>650</td> </tr> </tbody> </table>	CC	KK	LL	BB	1118	1248	1335	1335	CC	KK	LL	BB	433	563	650	650	<p>B05-9521-00-xx-NS</p> <p>REC</p> <p>ROUGH & TRIM PACKAGE</p> <table border="1"> <thead> <tr> <th>CC</th> <th>KK</th> <th>LL</th> <th>BB</th> </tr> </thead> <tbody> <tr> <td>1153</td> <td>1293</td> <td>1387</td> <td>1387</td> </tr> </tbody> </table> <p>TRIM ONLY</p> <p>T05-9521-00-xx</p> <table border="1"> <thead> <tr> <th>CC</th> <th>KK</th> <th>LL</th> <th>BB</th> </tr> </thead> <tbody> <tr> <td>468</td> <td>608</td> <td>702</td> <td>702</td> </tr> </tbody> </table>	CC	KK	LL	BB	1153	1293	1387	1387	CC	KK	LL	BB	468	608	702	702	<p>B35-9521-00-xx-NS</p> <p>MARIE</p> <p>ROUGH & TRIM PACKAGE</p> <table border="1"> <thead> <tr> <th>Plate - CC</th> <th>Plate - Others</th> </tr> </thead> <tbody> <tr> <td>1731</td> <td>1948</td> </tr> </tbody> </table> <p>TRIM ONLY</p> <p>T35-9521-00-xx</p> <table border="1"> <thead> <tr> <th>Plate - CC</th> <th>Plate - Others</th> </tr> </thead> <tbody> <tr> <td>1046</td> <td>1263</td> </tr> </tbody> </table>	Plate - CC	Plate - Others	1731	1948	Plate - CC	Plate - Others	1046	1263	<p>B45-9521-00-xx-NS</p> <p>SENS</p> <p>ROUGH & TRIM PACKAGE</p> <table border="1"> <thead> <tr> <th>CC</th> <th>KK</th> <th>LL</th> <th>BB</th> </tr> </thead> <tbody> <tr> <td>1081</td> <td>1200</td> <td>1279</td> <td>1279</td> </tr> </tbody> </table> <p>TRIM ONLY</p> <p>T45-9521-00-xx</p> <table border="1"> <thead> <tr> <th>CC</th> <th>KK</th> <th>LL</th> <th>BB</th> </tr> </thead> <tbody> <tr> <td>396</td> <td>515</td> <td>594</td> <td>594</td> </tr> </tbody> </table>	CC	KK	LL	BB	1081	1200	1279	1279	CC	KK	LL	BB	396	515	594	594	<p>B46-9521-00-xx-NS</p> <p>PROFILE</p> <p>ROUGH & TRIM PACKAGE</p> <table border="1"> <thead> <tr> <th>CC</th> <th>KK</th> <th>LL</th> <th>BB</th> </tr> </thead> <tbody> <tr> <td>1118</td> <td>1248</td> <td>1335</td> <td>1335</td> </tr> </tbody> </table> <p>TRIM ONLY</p> <p>T46-9521-00-xx</p> <table border="1"> <thead> <tr> <th>CC</th> <th>KK</th> <th>LL</th> <th>BB</th> </tr> </thead> <tbody> <tr> <td>433</td> <td>563</td> <td>650</td> <td>650</td> </tr> </tbody> </table>	CC	KK	LL	BB	1118	1248	1335	1335	CC	KK	LL	BB	433	563	650	650				
CC	KK	LL	BB																																																																													
1118	1248	1335	1335																																																																													
CC	KK	LL	BB																																																																													
433	563	650	650																																																																													
CC	KK	LL	BB																																																																													
1153	1293	1387	1387																																																																													
CC	KK	LL	BB																																																																													
468	608	702	702																																																																													
Plate - CC	Plate - Others																																																																															
1731	1948																																																																															
Plate - CC	Plate - Others																																																																															
1046	1263																																																																															
CC	KK	LL	BB																																																																													
1081	1200	1279	1279																																																																													
CC	KK	LL	BB																																																																													
396	515	594	594																																																																													
CC	KK	LL	BB																																																																													
1118	1248	1335	1335																																																																													
CC	KK	LL	BB																																																																													
433	563	650	650																																																																													
<p>B51-9521-00-xx-NS</p> <p>MA</p> <p>ROUGH & TRIM PACKAGE</p> <table border="1"> <thead> <tr> <th>CC</th> <th>CF</th> <th>KK</th> <th>BB</th> </tr> </thead> <tbody> <tr> <td>1303</td> <td>1303</td> <td>1489</td> <td>1613</td> </tr> </tbody> </table> <p>TRIM ONLY</p> <p>T51-9521-00-xx</p> <table border="1"> <thead> <tr> <th>CC</th> <th>CF</th> <th>KK</th> <th>BB</th> </tr> </thead> <tbody> <tr> <td>618</td> <td>618</td> <td>804</td> <td>928</td> </tr> </tbody> </table>	CC	CF	KK	BB	1303	1303	1489	1613	CC	CF	KK	BB	618	618	804	928	<p>B56-9521-00-xx-NS</p> <p>ACCENT</p> <p>ROUGH & TRIM PACKAGE</p> <table border="1"> <thead> <tr> <th>CC</th> <th>CB</th> <th>CF</th> </tr> </thead> <tbody> <tr> <td>1303</td> <td>1303</td> <td>1303</td> </tr> </tbody> </table> <p>TRIM ONLY</p> <p>T56-9521-00-xx</p> <table border="1"> <thead> <tr> <th>CC</th> <th>CB</th> <th>CF</th> </tr> </thead> <tbody> <tr> <td>618</td> <td>618</td> <td>618</td> </tr> </tbody> </table>	CC	CB	CF	1303	1303	1303	CC	CB	CF	618	618	618	<p>B66-9521-00-xx-NS</p> <p>ZIP</p> <p>ROUGH & TRIM PACKAGE</p> <table border="1"> <thead> <tr> <th>CC</th> <th>KK</th> <th>LL</th> <th>BB</th> </tr> </thead> <tbody> <tr> <td>1069</td> <td>1184</td> <td>1261</td> <td>1261</td> </tr> </tbody> </table> <p>TRIM ONLY</p> <p>T66-9521-00-xx</p> <table border="1"> <thead> <tr> <th>CC</th> <th>KK</th> <th>LL</th> <th>BB</th> </tr> </thead> <tbody> <tr> <td>384</td> <td>499</td> <td>576</td> <td>576</td> </tr> </tbody> </table>	CC	KK	LL	BB	1069	1184	1261	1261	CC	KK	LL	BB	384	499	576	576	<p>B80-9521-00-xx-NS</p> <p>AIR</p> <p>Available Q3 2023</p> <p>VALVE WITHOUT HANDLE</p> <table border="1"> <thead> <tr> <th>CC</th> <th>KK</th> <th>LL</th> <th>BB</th> </tr> </thead> <tbody> <tr> <td>1050</td> <td>1160</td> <td>1233</td> <td>1233</td> </tr> </tbody> </table> <p>TRIM (WITHOUT HANDLE)</p> <p>T80-9521-00-xx</p> <table border="1"> <thead> <tr> <th>CC</th> <th>KK</th> <th>LL</th> <th>BB</th> </tr> </thead> <tbody> <tr> <td>365</td> <td>475</td> <td>548</td> <td>548</td> </tr> </tbody> </table>	CC	KK	LL	BB	1050	1160	1233	1233	CC	KK	LL	BB	365	475	548	548	<p>B80-9522-00-xx-NS</p> <p>AIR</p> <p>Available Q3 2023</p> <p>VALVE WITHOUT HANDLE</p> <table border="1"> <thead> <tr> <th>CC</th> <th>KK</th> <th>LL</th> <th>BB</th> </tr> </thead> <tbody> <tr> <td>1050</td> <td>1160</td> <td>1233</td> <td>1233</td> </tr> </tbody> </table> <p>TRIM (WITHOUT HANDLE)</p> <p>T80-9522-00-xx</p> <table border="1"> <thead> <tr> <th>CC</th> <th>KK</th> <th>LL</th> <th>BB</th> </tr> </thead> <tbody> <tr> <td>365</td> <td>475</td> <td>548</td> <td>548</td> </tr> </tbody> </table>	CC	KK	LL	BB	1050	1160	1233	1233	CC	KK	LL	BB	365	475	548	548
CC	CF	KK	BB																																																																													
1303	1303	1489	1613																																																																													
CC	CF	KK	BB																																																																													
618	618	804	928																																																																													
CC	CB	CF																																																																														
1303	1303	1303																																																																														
CC	CB	CF																																																																														
618	618	618																																																																														
CC	KK	LL	BB																																																																													
1069	1184	1261	1261																																																																													
CC	KK	LL	BB																																																																													
384	499	576	576																																																																													
CC	KK	LL	BB																																																																													
1050	1160	1233	1233																																																																													
CC	KK	LL	BB																																																																													
365	475	548	548																																																																													
CC	KK	LL	BB																																																																													
1050	1160	1233	1233																																																																													
CC	KK	LL	BB																																																																													
365	475	548	548																																																																													

Finishes:

CC = chrome, CD = chrome diamond, CF = smokey chrome, KK = matte black, LL = satin brass, BB = white, NN = brushed nickel, YY = polished nickel, TT = venetian bronze, VV = satin copper, GG = gold, KM = black titanium, CB = chrome white, KB = matte black white, LB = satin brass white, NB = brushed nickel white, YB = polished nickel white, TB = venetian bronze, VB = satin copper white, GB = gold white

SHOWER VALVES

3-WAY THERMOSTATIC PRESSURE BALANCED

RVA-9531-X0-B

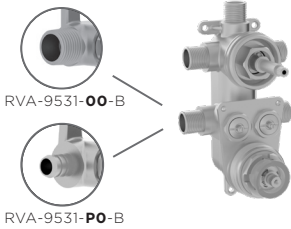

3-way thermostatic pressure balanced rough (shared port)

- A- 1 outlet: 7.9 gpm - 60 psi, 2 outlets: 3.7 gpm - 60 psi
- B- The best solution to minimize temperature fluctuations
- C- 3-way diverter with shared port
- D- Reversible check / non-return valves in case of water supply inversion
- E- CAR-2661-00 (temperature), CAR-9531-03 (diverter)
- F- Large depth adjustment range
- G- 1-3/8" decorative extension for thick wall or to correct deep rough-ins: order EXT-9520-30-xx

RVA-9531-00-B

3-way type TP rough (shared port) - 1/2" male NPT or welded copper connections

795

RVA-9531-P0-B

3-way type TP rough (shared port) - PEX connections

795

B04-9531-00-xx

PETITE



ROUGH & TRIM PACKAGE

CC	KK	LL	BB
1228	1358	1445	1445

TRIM ONLY

T04-9531-00-xx

CC	KK	LL	BB
433	563	650	650

B05-9531-00-xx

REC



ROUGH & TRIM PACKAGE

CC	KK	LL	BB
1263	1403	1497	1497

TRIM ONLY

T05-9531-00-xx

CC	KK	LL	BB
468	608	702	702

B45-9531-00-xx

SENS



ROUGH & TRIM PACKAGE

CC	KK	LL	BB
1191	1310	1389	1389

TRIM ONLY

T45-9531-00-xx

CC	KK	LL	BB
396	515	594	594

B46-9531-00-xx

PROFILE



ROUGH & TRIM PACKAGE

CC	KK	LL	BB
1228	1358	1445	1445

TRIM ONLY

T46-9531-00-xx

CC	KK	LL	BB
433	563	650	650

B51-9531-00-xx

MA



ROUGH & TRIM PACKAGE

CC	CF	KK	BB
1413	1413	1599	1721

TRIM ONLY

T51-9531-00-xx

CC	CF	KK	BB
618	618	804	928

B56-9531-00-xx

ACCENT



ROUGH & TRIM PACKAGE

CC	CB	CF
1413	1413	1413

TRIM ONLY

T56-9531-00-xx

CC	CB	CF
618	618	618

B66-9531-00-xx

ZIP



ROUGH & TRIM PACKAGE

CC	KK	LL	BB
1179	1294	1371	1371

TRIM ONLY

T66-9531-00-xx

CC	KK	LL	BB
384	499	576	576

B80-9531-00-xx

AIR

Available Q3 2023



VALVE WITHOUT HANDLE

CC	KK	LL	BB
1160	1270	1343	1343

TRIM (WITHOUT HANDLE)

T80-9531-00-xx

CC	KK	LL	BB
365	475	548	548

B80-9532-00-xx

AIR

Available Q3 2023



VALVE WITHOUT HANDLE

CC	KK	LL	BB
1160	1270	1343	1343

TRIM (WITHOUT HANDLE)

T80-9532-00-xx

CC	KK	LL	BB
365	475	548	548

Actual products may differ from pictures. Actual products measures may differ from the measures shown. All USD prices are subject to change without notice. Effective as of August 2023.

RVA-9531-XO-NS-B

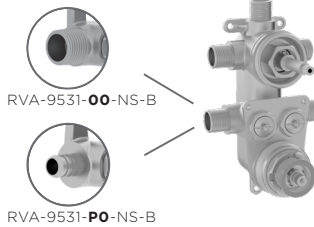

3-way thermostatic pressure balanced rough (non-shared port)

- A- 7.9 gpm - 60 psi
- B- The best solution to minimize temperature fluctuations
- C- 3-way diverter with non-shared port
- D- Reversible check / non-return valves in case of water supply inversion
- E- CAR-2661-00 (temperature), CAR-9531-03-NS (diverter)
- F- Large depth adjustment range
- G- 1-3/8" decorative extension for thick wall or to correct deep rough-ins: order EXT-9520-30-xx

RVA-9531-00-NS-B

3-way type TP rough (non-shared port) - 1/2" male NPT or welded copper connections

795

RVA-9531-PO-NS-B

3-way type TP rough (non-shared port) - PEX connections

795

B04-9531-00-xx-NS

PETITE



ROUGH & TRIM PACKAGE

CC	KK	LL	BB
1228	1358	1445	1445

TRIM ONLY

T04-9531-00-xx

CC	KK	LL	BB
433	563	650	650

B05-9531-00-xx-NS

REC



ROUGH & TRIM PACKAGE

CC	KK	LL	BB
1263	1403	1497	1497

TRIM ONLY

T05-9531-00-xx

CC	KK	LL	BB
468	608	702	702

B45-9531-00-xx-NS

SENS



ROUGH & TRIM PACKAGE

CC	KK	LL	BB
1191	1310	1389	1389

TRIM ONLY

T45-9531-00-xx

CC	KK	LL	BB
396	515	594	594

B46-9531-00-xx-NS

PROFILE



ROUGH & TRIM PACKAGE

CC	KK	LL	BB
1228	1358	1445	1445

TRIM ONLY

T46-9531-00-xx

CC	KK	LL	BB
433	563	650	650

B51-9531-00-xx-NS

MA



ROUGH & TRIM PACKAGE

CC	CF	KK	BB
1413	1413	1599	1721

TRIM ONLY

T51-9531-00-xx

CC	CF	KK	BB
618	618	804	928

B56-9531-00-xx-NS

ACCENT



ROUGH & TRIM PACKAGE

CC	CB	CF
1413	1413	1413

TRIM ONLY

T56-9531-00-xx

CC	CB	CF
618	618	618

B66-9531-00-xx-NS

ZIP



ROUGH & TRIM PACKAGE

CC	KK	LL	BB
1179	1294	1371	1371

TRIM ONLY

T66-9531-00-xx

CC	KK	LL	BB
384	499	576	576

B80-9531-00-xx-NS

AIR

Available Q3 2023



VALVE WITHOUT HANDLE

CC	KK	LL	BB
1160	1270	1343	1343

TRIM (WITHOUT HANDLE)

T80-9531-00-xx

CC	KK	LL	BB
365	475	548	548

B80-9532-00-xx-NS

AIR

Available Q3 2023



VALVE WITHOUT HANDLE

CC	KK	LL	BB
1160	1270	1343	1343

TRIM (WITHOUT HANDLE)

T80-9532-00-xx

CC	KK	LL	BB
365	475	548	548

Finishes:

CC = chrome, CD = chrome diamond, CF = smokey chrome, KK = matte black, LL = satin brass, BB = white, NN = brushed nickel, YY = polished nickel, TT = venetian bronze, VV = satin copper, GG = gold, KM = black titanium, CB = chrome white, KB = matte black white, LB = satin brass white, NB = brushed nickel white, YB = polished nickel white, TB = venetian bronze, VB = satin copper white, GB = gold white

SHOWER VALVES

2-PORT DIVERTER

RVA-9562-00-B



2-port diverter rough valve with off (shared port)

- A- 1 outlet: 10.5 gpm – 60 psi, 2 outlets: 4 gpm – 60 psi
- B- Can replace 2 volume control valves
- C- Up to 2 accessories can be used at the same time
- D- CAR-9525-02
- E- Extra long cartridge for maximum adjustment
- F- 1/2" male NPT or welded copper connections

RVA-9562-00-B

2-port diverter rough (shared port) - 1/2" male NPT or welded copper connections

299

<p>B04-9560-02-xx</p> <p>PETITE</p> <p>ROUGH & TRIM PACKAGE</p> <table border="1"> <thead> <tr> <th>CC</th> <th>KK</th> <th>LL</th> <th>BB</th> </tr> </thead> <tbody> <tr> <td>513</td> <td>577</td> <td>620</td> <td>620</td> </tr> </tbody> </table> <p>TRIM ONLY</p> <p>T04-9560-02-xx</p> <table border="1"> <thead> <tr> <th>CC</th> <th>KK</th> <th>LL</th> <th>BB</th> </tr> </thead> <tbody> <tr> <td>214</td> <td>278</td> <td>321</td> <td>321</td> </tr> </tbody> </table>	CC	KK	LL	BB	513	577	620	620	CC	KK	LL	BB	214	278	321	321	<p>B05-9560-02-xx</p> <p>REC</p> <p>ROUGH & TRIM PACKAGE</p> <table border="1"> <thead> <tr> <th>CC</th> <th>KK</th> <th>LL</th> <th>BB</th> </tr> </thead> <tbody> <tr> <td>543</td> <td>616</td> <td>665</td> <td>665</td> </tr> </tbody> </table> <p>TRIM ONLY</p> <p>T05-9560-02-xx</p> <table border="1"> <thead> <tr> <th>CC</th> <th>KK</th> <th>LL</th> <th>BB</th> </tr> </thead> <tbody> <tr> <td>244</td> <td>317</td> <td>366</td> <td>366</td> </tr> </tbody> </table>	CC	KK	LL	BB	543	616	665	665	CC	KK	LL	BB	244	317	366	366	<p>B16-9560-02-xx</p> <p>NAUTICA</p> <p>ROUGH & TRIM PACKAGE</p> <table border="1"> <thead> <tr> <th>CC</th> <th>KK</th> <th>LL</th> <th>BB</th> </tr> </thead> <tbody> <tr> <td>586</td> <td>672</td> <td>730</td> <td>730</td> </tr> </tbody> </table> <p>TRIM ONLY</p> <p>T16-9560-02-xx</p> <table border="1"> <thead> <tr> <th>CC</th> <th>KK</th> <th>LL</th> <th>BB</th> </tr> </thead> <tbody> <tr> <td>287</td> <td>373</td> <td>431</td> <td>431</td> </tr> </tbody> </table>	CC	KK	LL	BB	586	672	730	730	CC	KK	LL	BB	287	373	431	431	<p>B18-9560-02-xx</p> <p>RALPH</p> <p>ROUGH & TRIM PACKAGE</p> <table border="1"> <thead> <tr> <th>CC/CB</th> <th>KK/KB</th> <th>LL/LB</th> <th>BB</th> </tr> </thead> <tbody> <tr> <td>586</td> <td>672</td> <td>730</td> <td>730</td> </tr> </tbody> </table> <p>TRIM ONLY</p> <p>T18-9560-02-xx</p> <table border="1"> <thead> <tr> <th>CC/CB</th> <th>KK/KB</th> <th>LL/LB</th> <th>BB</th> </tr> </thead> <tbody> <tr> <td>287</td> <td>373</td> <td>431</td> <td>431</td> </tr> </tbody> </table>	CC/CB	KK/KB	LL/LB	BB	586	672	730	730	CC/CB	KK/KB	LL/LB	BB	287	373	431	431	<p>B26-9560-02-xx</p> <p>HAÜS-D</p> <p>ROUGH & TRIM PACKAGE</p> <table border="1"> <thead> <tr> <th>CD</th> </tr> </thead> <tbody> <tr> <td>723</td> </tr> </tbody> </table> <p>TRIM ONLY</p> <p>T26-9560-02-xx</p> <table border="1"> <thead> <tr> <th>CD</th> </tr> </thead> <tbody> <tr> <td>424</td> </tr> </tbody> </table>	CD	723	CD	424												
CC	KK	LL	BB																																																																																	
513	577	620	620																																																																																	
CC	KK	LL	BB																																																																																	
214	278	321	321																																																																																	
CC	KK	LL	BB																																																																																	
543	616	665	665																																																																																	
CC	KK	LL	BB																																																																																	
244	317	366	366																																																																																	
CC	KK	LL	BB																																																																																	
586	672	730	730																																																																																	
CC	KK	LL	BB																																																																																	
287	373	431	431																																																																																	
CC/CB	KK/KB	LL/LB	BB																																																																																	
586	672	730	730																																																																																	
CC/CB	KK/KB	LL/LB	BB																																																																																	
287	373	431	431																																																																																	
CD																																																																																				
723																																																																																				
CD																																																																																				
424																																																																																				
<p>B27-9560-02-xx</p> <p>HAÜS-C</p> <p>ROUGH & TRIM PACKAGE</p> <table border="1"> <thead> <tr> <th>CC</th> <th>KK</th> <th>LL</th> <th>BB</th> </tr> </thead> <tbody> <tr> <td>586</td> <td>672</td> <td>730</td> <td>730</td> </tr> </tbody> </table> <p>TRIM ONLY</p> <p>T27-9560-02-xx</p> <table border="1"> <thead> <tr> <th>CC</th> <th>KK</th> <th>LL</th> <th>BB</th> </tr> </thead> <tbody> <tr> <td>287</td> <td>373</td> <td>431</td> <td>431</td> </tr> </tbody> </table>	CC	KK	LL	BB	586	672	730	730	CC	KK	LL	BB	287	373	431	431	<p>B28-9560-02-xx</p> <p>HAÜS-L</p> <p>ROUGH & TRIM PACKAGE</p> <table border="1"> <thead> <tr> <th>CC</th> <th>KK</th> <th>LL</th> <th>BB</th> </tr> </thead> <tbody> <tr> <td>586</td> <td>672</td> <td>730</td> <td>730</td> </tr> </tbody> </table> <p>TRIM ONLY</p> <p>T28-9560-02-xx</p> <table border="1"> <thead> <tr> <th>CC</th> <th>KK</th> <th>LL</th> <th>BB</th> </tr> </thead> <tbody> <tr> <td>287</td> <td>373</td> <td>431</td> <td>431</td> </tr> </tbody> </table>	CC	KK	LL	BB	586	672	730	730	CC	KK	LL	BB	287	373	431	431	<p>B45-9560-02-xx</p> <p>SENS</p> <p>ROUGH & TRIM PACKAGE</p> <table border="1"> <thead> <tr> <th>CC</th> <th>KK</th> <th>LL</th> <th>BB</th> </tr> </thead> <tbody> <tr> <td>498</td> <td>558</td> <td>598</td> <td>598</td> </tr> </tbody> </table> <p>TRIM ONLY</p> <p>T45-9560-02-xx</p> <table border="1"> <thead> <tr> <th>CC</th> <th>KK</th> <th>LL</th> <th>BB</th> </tr> </thead> <tbody> <tr> <td>199</td> <td>259</td> <td>299</td> <td>299</td> </tr> </tbody> </table>	CC	KK	LL	BB	498	558	598	598	CC	KK	LL	BB	199	259	299	299	<p>B46-9560-02-xx</p> <p>PROFILE</p> <p>ROUGH & TRIM PACKAGE</p> <table border="1"> <thead> <tr> <th>CC</th> <th>KK</th> <th>LL</th> <th>BB</th> </tr> </thead> <tbody> <tr> <td>513</td> <td>577</td> <td>620</td> <td>620</td> </tr> </tbody> </table> <p>TRIM ONLY</p> <p>T46-9560-02-xx</p> <table border="1"> <thead> <tr> <th>CC</th> <th>KK</th> <th>LL</th> <th>BB</th> </tr> </thead> <tbody> <tr> <td>214</td> <td>278</td> <td>321</td> <td>321</td> </tr> </tbody> </table>	CC	KK	LL	BB	513	577	620	620	CC	KK	LL	BB	214	278	321	321	<p>B47-9560-02-xx</p> <p>FLORA</p> <p>ROUGH & TRIM PACKAGE</p> <table border="1"> <thead> <tr> <th>Cx</th> <th>Kx</th> <th>Lx</th> <th>Bx</th> </tr> </thead> <tbody> <tr> <td>616</td> <td>711</td> <td>775</td> <td>775</td> </tr> </tbody> </table> <p>TRIM ONLY</p> <p>T47-9560-02-xx</p> <table border="1"> <thead> <tr> <th>Cx</th> <th>Kx</th> <th>Lx</th> <th>Bx</th> </tr> </thead> <tbody> <tr> <td>317</td> <td>412</td> <td>476</td> <td>476</td> </tr> </tbody> </table>	Cx	Kx	Lx	Bx	616	711	775	775	Cx	Kx	Lx	Bx	317	412	476	476
CC	KK	LL	BB																																																																																	
586	672	730	730																																																																																	
CC	KK	LL	BB																																																																																	
287	373	431	431																																																																																	
CC	KK	LL	BB																																																																																	
586	672	730	730																																																																																	
CC	KK	LL	BB																																																																																	
287	373	431	431																																																																																	
CC	KK	LL	BB																																																																																	
498	558	598	598																																																																																	
CC	KK	LL	BB																																																																																	
199	259	299	299																																																																																	
CC	KK	LL	BB																																																																																	
513	577	620	620																																																																																	
CC	KK	LL	BB																																																																																	
214	278	321	321																																																																																	
Cx	Kx	Lx	Bx																																																																																	
616	711	775	775																																																																																	
Cx	Kx	Lx	Bx																																																																																	
317	412	476	476																																																																																	
<p>B56-9560-02-xx</p> <p>ACCENT</p> <p>ROUGH & TRIM PACKAGE</p> <table border="1"> <thead> <tr> <th>CC</th> <th>CB</th> <th>CF</th> </tr> </thead> <tbody> <tr> <td>596</td> <td>596</td> <td>596</td> </tr> </tbody> </table> <p>TRIM ONLY</p> <p>T56-9560-02-xx</p> <table border="1"> <thead> <tr> <th>CC</th> <th>CB</th> <th>CF</th> </tr> </thead> <tbody> <tr> <td>297</td> <td>297</td> <td>297</td> </tr> </tbody> </table>	CC	CB	CF	596	596	596	CC	CB	CF	297	297	297	<p>B66-9560-02-xx</p> <p>ZIP</p> <p>ROUGH & TRIM PACKAGE</p> <table border="1"> <thead> <tr> <th>CC</th> <th>KK</th> <th>LL</th> <th>BB</th> </tr> </thead> <tbody> <tr> <td>487</td> <td>543</td> <td>581</td> <td>581</td> </tr> </tbody> </table> <p>TRIM ONLY</p> <p>T66-9560-02-xx</p> <table border="1"> <thead> <tr> <th>CC</th> <th>KK</th> <th>LL</th> <th>BB</th> </tr> </thead> <tbody> <tr> <td>188</td> <td>244</td> <td>282</td> <td>282</td> </tr> </tbody> </table>	CC	KK	LL	BB	487	543	581	581	CC	KK	LL	BB	188	244	282	282	<p>B71-9560-02-xx</p> <p>EVA</p> <p>ROUGH & TRIM PACKAGE</p> <table border="1"> <thead> <tr> <th>CC</th> <th>KK</th> <th>LL</th> <th>BB</th> </tr> </thead> <tbody> <tr> <td>586</td> <td>672</td> <td>730</td> <td>730</td> </tr> </tbody> </table> <p>TRIM ONLY</p> <p>T71-9560-02-xx</p> <table border="1"> <thead> <tr> <th>CC</th> <th>KK</th> <th>LL</th> <th>BB</th> </tr> </thead> <tbody> <tr> <td>287</td> <td>373</td> <td>431</td> <td>431</td> </tr> </tbody> </table>	CC	KK	LL	BB	586	672	730	730	CC	KK	LL	BB	287	373	431	431	<p>B72-9560-02-xx</p> <p>TRADITION</p> <p>ROUGH & TRIM PACKAGE</p> <table border="1"> <thead> <tr> <th>CC</th> <th>KK</th> <th>LL</th> <th>BB</th> </tr> </thead> <tbody> <tr> <td>586</td> <td>672</td> <td>730</td> <td>730</td> </tr> </tbody> </table> <p>TRIM ONLY</p> <p>T72-9560-02-xx</p> <table border="1"> <thead> <tr> <th>CC</th> <th>KK</th> <th>LL</th> <th>BB</th> </tr> </thead> <tbody> <tr> <td>287</td> <td>373</td> <td>431</td> <td>431</td> </tr> </tbody> </table>	CC	KK	LL	BB	586	672	730	730	CC	KK	LL	BB	287	373	431	431	<p>B74-9560-02-xx</p> <p>VICTOIRE</p> <p>ROUGH & TRIM PACKAGE</p> <table border="1"> <thead> <tr> <th>CB</th> <th>KB</th> <th>LB</th> <th>BB</th> </tr> </thead> <tbody> <tr> <td>586</td> <td>672</td> <td>730</td> <td>730</td> </tr> </tbody> </table> <p>TRIM ONLY</p> <p>T74-9560-02-xx</p> <table border="1"> <thead> <tr> <th>CB</th> <th>KB</th> <th>LB</th> <th>BB</th> </tr> </thead> <tbody> <tr> <td>287</td> <td>373</td> <td>431</td> <td>431</td> </tr> </tbody> </table>	CB	KB	LB	BB	586	672	730	730	CB	KB	LB	BB	287	373	431	431				
CC	CB	CF																																																																																		
596	596	596																																																																																		
CC	CB	CF																																																																																		
297	297	297																																																																																		
CC	KK	LL	BB																																																																																	
487	543	581	581																																																																																	
CC	KK	LL	BB																																																																																	
188	244	282	282																																																																																	
CC	KK	LL	BB																																																																																	
586	672	730	730																																																																																	
CC	KK	LL	BB																																																																																	
287	373	431	431																																																																																	
CC	KK	LL	BB																																																																																	
586	672	730	730																																																																																	
CC	KK	LL	BB																																																																																	
287	373	431	431																																																																																	
CB	KB	LB	BB																																																																																	
586	672	730	730																																																																																	
CB	KB	LB	BB																																																																																	
287	373	431	431																																																																																	

Actual products may differ from pictures. Actual products measures may differ from the measures shown. All USD prices are subject to change without notice. Effective as of August 2023.

RVA-9562-00-B



2-port diverter rough valve with off (shared port)

- A- 1 outlet: 10.5 gpm - 60 psi, 2 outlets: 4 gpm - 60 psi
- B- Can replace 2 volume control valves
- C- Up to 2 accessories can be used at the same time
- D- CAR-9525-02
- E- Extra long cartridge for maximum adjustment
- F- 1/2" male NPT or welded copper connections

RVA-9562-00-B

2-port diverter rough (shared port) - 1/2" male NPT or welded copper connections

299

B80-9560-02-xx

AIR

Available
Q3 2023



TRIM (WITHOUT HANDLE)

CC	KK	LL	BB
399	429	449	449

TRIM ONLY

T80-9560-02-xx

CC	KK	LL	BB
100	130	150	150

Finishes:

CC = chrome, CD = chrome diamond, CF = smokey chrome, KK = matte black, LL = satin brass, BB = white, NN = brushed nickel, YY = polished nickel, TT = venetian bronze, VV = satin copper, GG = gold, KM = black titanium, CB = chrome white, KB = matte black white, LB = satin brass white, NB = brushed nickel white, YB = polished nickel white, TB = venetian bronze, VB = satin copper white, GB = gold white

SHOWER VALVES

2-PORT DIVERTER

RVA-9562-00-NS-B

















2-port diverter rough valve with off (non-shared port)

- A- 10.5 gpm - 60 psi
- B- Can replace 2 volume control valves
- C- 1 accessory works at a time
- D- CAR-9525-02-NS
- E- Extra long cartridge for maximum adjustment
- F- 1/2" male NPT or welded copper connections

RVA-9562-00-NS-B 2-port diverter rough (non-shared port) - 1/2" male NPT or welded copper connections

299

<p>B04-9560-02-xx-NS</p> <p>PETITE</p>  <p>ROUGH & TRIM PACKAGE</p> <table border="1"> <thead> <tr><th>CC</th><th>KK</th><th>LL</th><th>BB</th></tr> </thead> <tbody> <tr><td>513</td><td>577</td><td>620</td><td>620</td></tr> </tbody> </table> <p>TRIM ONLY</p> <p>T04-9560-02-xx</p> <table border="1"> <thead> <tr><th>CC</th><th>KK</th><th>LL</th><th>BB</th></tr> </thead> <tbody> <tr><td>214</td><td>278</td><td>321</td><td>321</td></tr> </tbody> </table>	CC	KK	LL	BB	513	577	620	620	CC	KK	LL	BB	214	278	321	321	<p>B05-9560-02-xx-NS</p> <p>REC</p>  <p>ROUGH & TRIM PACKAGE</p> <table border="1"> <thead> <tr><th>CC</th><th>KK</th><th>LL</th><th>BB</th></tr> </thead> <tbody> <tr><td>543</td><td>616</td><td>665</td><td>665</td></tr> </tbody> </table> <p>TRIM ONLY</p> <p>T05-9560-02-xx</p> <table border="1"> <thead> <tr><th>CC</th><th>KK</th><th>LL</th><th>BB</th></tr> </thead> <tbody> <tr><td>244</td><td>317</td><td>366</td><td>366</td></tr> </tbody> </table>	CC	KK	LL	BB	543	616	665	665	CC	KK	LL	BB	244	317	366	366	<p>B16-9560-02-xx-NS</p> <p>NAUTICA</p>  <p>ROUGH & TRIM PACKAGE</p> <table border="1"> <thead> <tr><th>CC</th><th>KK</th><th>LL</th><th>BB</th></tr> </thead> <tbody> <tr><td>586</td><td>672</td><td>730</td><td>730</td></tr> </tbody> </table> <p>TRIM ONLY</p> <p>T16-9560-02-xx</p> <table border="1"> <thead> <tr><th>CC</th><th>KK</th><th>LL</th><th>BB</th></tr> </thead> <tbody> <tr><td>287</td><td>373</td><td>431</td><td>431</td></tr> </tbody> </table>	CC	KK	LL	BB	586	672	730	730	CC	KK	LL	BB	287	373	431	431	<p>B18-9560-02-xx-NS</p> <p>RALPH</p>  <p>ROUGH & TRIM PACKAGE</p> <table border="1"> <thead> <tr><th>CC/CB</th><th>KK/KB</th><th>LL/LB</th><th>BB</th></tr> </thead> <tbody> <tr><td>586</td><td>672</td><td>730</td><td>730</td></tr> </tbody> </table> <p>TRIM ONLY</p> <p>T18-9560-02-xx</p> <table border="1"> <thead> <tr><th>CC/CB</th><th>KK/KB</th><th>LL/LB</th><th>BB</th></tr> </thead> <tbody> <tr><td>287</td><td>373</td><td>431</td><td>431</td></tr> </tbody> </table>	CC/CB	KK/KB	LL/LB	BB	586	672	730	730	CC/CB	KK/KB	LL/LB	BB	287	373	431	431	<p>B26-9560-02-xx-NS</p> <p>HAÜS-D</p>  <p>ROUGH & TRIM PACKAGE</p> <table border="1"> <thead> <tr><th>CD</th></tr> </thead> <tbody> <tr><td>723</td></tr> </tbody> </table> <p>TRIM ONLY</p> <p>T26-9560-02-xx</p> <table border="1"> <thead> <tr><th>CD</th></tr> </thead> <tbody> <tr><td>424</td></tr> </tbody> </table>	CD	723	CD	424												
CC	KK	LL	BB																																																																																	
513	577	620	620																																																																																	
CC	KK	LL	BB																																																																																	
214	278	321	321																																																																																	
CC	KK	LL	BB																																																																																	
543	616	665	665																																																																																	
CC	KK	LL	BB																																																																																	
244	317	366	366																																																																																	
CC	KK	LL	BB																																																																																	
586	672	730	730																																																																																	
CC	KK	LL	BB																																																																																	
287	373	431	431																																																																																	
CC/CB	KK/KB	LL/LB	BB																																																																																	
586	672	730	730																																																																																	
CC/CB	KK/KB	LL/LB	BB																																																																																	
287	373	431	431																																																																																	
CD																																																																																				
723																																																																																				
CD																																																																																				
424																																																																																				
<p>B27-9560-02-xx-NS</p> <p>HAÜS-C</p>  <p>ROUGH & TRIM PACKAGE</p> <table border="1"> <thead> <tr><th>CC</th><th>KK</th><th>LL</th><th>BB</th></tr> </thead> <tbody> <tr><td>586</td><td>672</td><td>730</td><td>730</td></tr> </tbody> </table> <p>TRIM ONLY</p> <p>T27-9560-02-xx</p> <table border="1"> <thead> <tr><th>CC</th><th>KK</th><th>LL</th><th>BB</th></tr> </thead> <tbody> <tr><td>287</td><td>373</td><td>431</td><td>431</td></tr> </tbody> </table>	CC	KK	LL	BB	586	672	730	730	CC	KK	LL	BB	287	373	431	431	<p>B28-9560-02-xx-NS</p> <p>HAÜS-L</p>  <p>ROUGH & TRIM PACKAGE</p> <table border="1"> <thead> <tr><th>CC</th><th>KK</th><th>LL</th><th>BB</th></tr> </thead> <tbody> <tr><td>586</td><td>672</td><td>730</td><td>730</td></tr> </tbody> </table> <p>TRIM ONLY</p> <p>T28-9560-02-xx</p> <table border="1"> <thead> <tr><th>CC</th><th>KK</th><th>LL</th><th>BB</th></tr> </thead> <tbody> <tr><td>287</td><td>373</td><td>431</td><td>431</td></tr> </tbody> </table>	CC	KK	LL	BB	586	672	730	730	CC	KK	LL	BB	287	373	431	431	<p>B45-9560-02-xx-NS</p> <p>SENS</p>  <p>ROUGH & TRIM PACKAGE</p> <table border="1"> <thead> <tr><th>CC</th><th>KK</th><th>LL</th><th>BB</th></tr> </thead> <tbody> <tr><td>498</td><td>558</td><td>598</td><td>598</td></tr> </tbody> </table> <p>TRIM ONLY</p> <p>T45-9560-02-xx</p> <table border="1"> <thead> <tr><th>CC</th><th>KK</th><th>LL</th><th>BB</th></tr> </thead> <tbody> <tr><td>199</td><td>259</td><td>299</td><td>299</td></tr> </tbody> </table>	CC	KK	LL	BB	498	558	598	598	CC	KK	LL	BB	199	259	299	299	<p>B46-9560-02-xx-NS</p> <p>PROFILE</p>  <p>ROUGH & TRIM PACKAGE</p> <table border="1"> <thead> <tr><th>CC</th><th>KK</th><th>LL</th><th>BB</th></tr> </thead> <tbody> <tr><td>513</td><td>577</td><td>620</td><td>620</td></tr> </tbody> </table> <p>TRIM ONLY</p> <p>T46-9560-02-xx</p> <table border="1"> <thead> <tr><th>CC</th><th>KK</th><th>LL</th><th>BB</th></tr> </thead> <tbody> <tr><td>214</td><td>278</td><td>321</td><td>321</td></tr> </tbody> </table>	CC	KK	LL	BB	513	577	620	620	CC	KK	LL	BB	214	278	321	321	<p>B47-9560-02-xx-NS</p> <p>FLORA</p>  <p>ROUGH & TRIM PACKAGE</p> <table border="1"> <thead> <tr><th>Cx</th><th>Kx</th><th>Lx</th><th>Bx</th></tr> </thead> <tbody> <tr><td>616</td><td>711</td><td>775</td><td>775</td></tr> </tbody> </table> <p>TRIM ONLY</p> <p>T47-9560-02-xx</p> <table border="1"> <thead> <tr><th>Cx</th><th>Kx</th><th>Lx</th><th>Bx</th></tr> </thead> <tbody> <tr><td>317</td><td>412</td><td>476</td><td>476</td></tr> </tbody> </table>	Cx	Kx	Lx	Bx	616	711	775	775	Cx	Kx	Lx	Bx	317	412	476	476
CC	KK	LL	BB																																																																																	
586	672	730	730																																																																																	
CC	KK	LL	BB																																																																																	
287	373	431	431																																																																																	
CC	KK	LL	BB																																																																																	
586	672	730	730																																																																																	
CC	KK	LL	BB																																																																																	
287	373	431	431																																																																																	
CC	KK	LL	BB																																																																																	
498	558	598	598																																																																																	
CC	KK	LL	BB																																																																																	
199	259	299	299																																																																																	
CC	KK	LL	BB																																																																																	
513	577	620	620																																																																																	
CC	KK	LL	BB																																																																																	
214	278	321	321																																																																																	
Cx	Kx	Lx	Bx																																																																																	
616	711	775	775																																																																																	
Cx	Kx	Lx	Bx																																																																																	
317	412	476	476																																																																																	
<p>B56-9560-02-xx-NS</p> <p>ACCENT</p>  <p>ROUGH & TRIM PACKAGE</p> <table border="1"> <thead> <tr><th>CC</th><th>CB</th><th>CF</th></tr> </thead> <tbody> <tr><td>596</td><td>596</td><td>596</td></tr> </tbody> </table> <p>TRIM ONLY</p> <p>T56-9560-02-xx</p> <table border="1"> <thead> <tr><th>CC</th><th>CB</th><th>CF</th></tr> </thead> <tbody> <tr><td>297</td><td>297</td><td>297</td></tr> </tbody> </table>	CC	CB	CF	596	596	596	CC	CB	CF	297	297	297	<p>B66-9560-02-xx-NS</p> <p>ZIP</p>  <p>ROUGH & TRIM PACKAGE</p> <table border="1"> <thead> <tr><th>CC</th><th>KK</th><th>LL</th><th>BB</th></tr> </thead> <tbody> <tr><td>487</td><td>543</td><td>581</td><td>581</td></tr> </tbody> </table> <p>TRIM ONLY</p> <p>T66-9560-02-xx</p> <table border="1"> <thead> <tr><th>CC</th><th>KK</th><th>LL</th><th>BB</th></tr> </thead> <tbody> <tr><td>188</td><td>244</td><td>282</td><td>282</td></tr> </tbody> </table>	CC	KK	LL	BB	487	543	581	581	CC	KK	LL	BB	188	244	282	282	<p>B71-9560-02-xx-NS</p> <p>EVA</p>  <p>ROUGH & TRIM PACKAGE</p> <table border="1"> <thead> <tr><th>CC</th><th>KK</th><th>LL</th><th>BB</th></tr> </thead> <tbody> <tr><td>586</td><td>672</td><td>730</td><td>730</td></tr> </tbody> </table> <p>TRIM ONLY</p> <p>T71-9560-02-xx</p> <table border="1"> <thead> <tr><th>CC</th><th>KK</th><th>LL</th><th>BB</th></tr> </thead> <tbody> <tr><td>287</td><td>373</td><td>431</td><td>431</td></tr> </tbody> </table>	CC	KK	LL	BB	586	672	730	730	CC	KK	LL	BB	287	373	431	431	<p>B72-9560-02-xx-NS</p> <p>TRADITION</p>  <p>ROUGH & TRIM PACKAGE</p> <table border="1"> <thead> <tr><th>CC</th><th>KK</th><th>LL</th><th>BB</th></tr> </thead> <tbody> <tr><td>586</td><td>672</td><td>730</td><td>730</td></tr> </tbody> </table> <p>TRIM ONLY</p> <p>T72-9560-02-xx</p> <table border="1"> <thead> <tr><th>CC</th><th>KK</th><th>LL</th><th>BB</th></tr> </thead> <tbody> <tr><td>287</td><td>373</td><td>431</td><td>431</td></tr> </tbody> </table>	CC	KK	LL	BB	586	672	730	730	CC	KK	LL	BB	287	373	431	431	<p>B74-9560-02-xx-NS</p> <p>VICTOIRE</p>  <p>ROUGH & TRIM PACKAGE</p> <table border="1"> <thead> <tr><th>CB</th><th>KB</th><th>LB</th><th>BB</th></tr> </thead> <tbody> <tr><td>586</td><td>672</td><td>730</td><td>730</td></tr> </tbody> </table> <p>TRIM ONLY</p> <p>T74-9560-02-xx</p> <table border="1"> <thead> <tr><th>CB</th><th>KB</th><th>LB</th><th>BB</th></tr> </thead> <tbody> <tr><td>287</td><td>373</td><td>431</td><td>431</td></tr> </tbody> </table>	CB	KB	LB	BB	586	672	730	730	CB	KB	LB	BB	287	373	431	431				
CC	CB	CF																																																																																		
596	596	596																																																																																		
CC	CB	CF																																																																																		
297	297	297																																																																																		
CC	KK	LL	BB																																																																																	
487	543	581	581																																																																																	
CC	KK	LL	BB																																																																																	
188	244	282	282																																																																																	
CC	KK	LL	BB																																																																																	
586	672	730	730																																																																																	
CC	KK	LL	BB																																																																																	
287	373	431	431																																																																																	
CC	KK	LL	BB																																																																																	
586	672	730	730																																																																																	
CC	KK	LL	BB																																																																																	
287	373	431	431																																																																																	
CB	KB	LB	BB																																																																																	
586	672	730	730																																																																																	
CB	KB	LB	BB																																																																																	
287	373	431	431																																																																																	

Actual products may differ from pictures. Actual products measures may differ from the measures shown. All USD prices are subject to change without notice. Effective as of August 2023.

RVA-9562-00-NS-B



2-port diverter rough valve with off (non-shared port)

- A- 10.5 gpm - 60 psi
- B- Can replace 2 volume control valves
- C- 1 accessory works at a time
- D- CAR-9525-02-NS
- E- Extra long cartridge for maximum adjustment
- F- 1/2" male NPT or welded copper connections

RVA-9562-00-NS-B 2-port diverter rough (non-shared port) - 1/2" male NPT or welded copper connections

299

B80-9560-02-xx-NS

AIR

Available Q3 2023



VALVE WITHOUT HANDLE

CC	KK	LL	BB
399	429	449	449

TRIM (WITHOUT HANDLE)

T80-9560-02-xx

CC	KK	LL	BB
100	130	150	150

Finishes:

CC = chrome, CD = chrome diamond, CF = smokey chrome, KK = matte black, LL = satin brass, BB = white, NN = brushed nickel, YY = polished nickel, TT = venetian bronze, VV = satin copper, GG = gold, KM = black titanium, CB = chrome white, KB = matte black white, LB = satin brass white, NB = brushed nickel white, YB = polished nickel white, TB = venetian bronze, VB = satin copper white, GB = gold white

SHOWER VALVES

3-PORT DIVERTER

RVA-9563-00-B

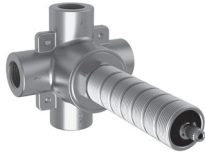















3-port diverter rough valve with off (shared port)

- A- 1 outlet: 9.7 gpm - 60 psi, 2 outlets: 5.2 gpm - 60 psi
- B- Can replace 3 volume control valves
- C- Up to 2 accessories can be used at the same time
- D- CAR-9530-03
- E- Extra long cartridge for maximum adjustment
- F- Inlet: 3/4" F NPT - outlets: 1/2" F NPT

RVA-9563-00-B

3-port diverter rough (shared port) - inlet: 3/4" F NPT - outlets: 1/2" F NPT

381

<div style="border: 1px solid black; padding: 5px;"> <p>B04-9560-03-xx</p> <p>PETITE</p>  <p>ROUGH & TRIM PACKAGE</p> <table border="1"> <thead> <tr><th>CC</th><th>KK</th><th>LL</th><th>BB</th></tr> </thead> <tbody> <tr><td>595</td><td>659</td><td>702</td><td>702</td></tr> </tbody> </table> <p>TRIM ONLY</p> <p>T04-9560-03-xx</p> <table border="1"> <thead> <tr><th>CC</th><th>KK</th><th>LL</th><th>BB</th></tr> </thead> <tbody> <tr><td>214</td><td>278</td><td>321</td><td>321</td></tr> </tbody> </table> </div>	CC	KK	LL	BB	595	659	702	702	CC	KK	LL	BB	214	278	321	321	<div style="border: 1px solid black; padding: 5px;"> <p>B05-9560-03-xx</p> <p>REC</p>  <p>ROUGH & TRIM PACKAGE</p> <table border="1"> <thead> <tr><th>CC</th><th>KK</th><th>LL</th><th>BB</th></tr> </thead> <tbody> <tr><td>625</td><td>698</td><td>747</td><td>747</td></tr> </tbody> </table> <p>TRIM ONLY</p> <p>T05-9560-03-xx</p> <table border="1"> <thead> <tr><th>CC</th><th>KK</th><th>LL</th><th>BB</th></tr> </thead> <tbody> <tr><td>244</td><td>317</td><td>366</td><td>366</td></tr> </tbody> </table> </div>	CC	KK	LL	BB	625	698	747	747	CC	KK	LL	BB	244	317	366	366	<div style="border: 1px solid black; padding: 5px;"> <p>B16-9560-03-xx</p> <p>NAUTICA</p>  <p>ROUGH & TRIM PACKAGE</p> <table border="1"> <thead> <tr><th>CC</th><th>KK</th><th>LL</th><th>BB</th></tr> </thead> <tbody> <tr><td>668</td><td>754</td><td>812</td><td>812</td></tr> </tbody> </table> <p>TRIM ONLY</p> <p>T16-9560-03-xx</p> <table border="1"> <thead> <tr><th>CC</th><th>KK</th><th>LL</th><th>BB</th></tr> </thead> <tbody> <tr><td>287</td><td>373</td><td>431</td><td>431</td></tr> </tbody> </table> </div>	CC	KK	LL	BB	668	754	812	812	CC	KK	LL	BB	287	373	431	431	<div style="border: 1px solid black; padding: 5px;"> <p>B18-9560-03-xx</p> <p>RALPH</p>  <p>ROUGH & TRIM PACKAGE</p> <table border="1"> <thead> <tr><th>CC/CB</th><th>KK/KB</th><th>LL/LB</th><th>BB</th></tr> </thead> <tbody> <tr><td>668</td><td>754</td><td>812</td><td>812</td></tr> </tbody> </table> <p>TRIM ONLY</p> <p>T18-9560-03-xx</p> <table border="1"> <thead> <tr><th>CC/CB</th><th>KK/KB</th><th>LL/LB</th><th>BB</th></tr> </thead> <tbody> <tr><td>287</td><td>373</td><td>431</td><td>431</td></tr> </tbody> </table> </div>	CC/CB	KK/KB	LL/LB	BB	668	754	812	812	CC/CB	KK/KB	LL/LB	BB	287	373	431	431	<div style="border: 1px solid black; padding: 5px;"> <p>B26-9560-03-xx</p> <p>HAÜS-D</p>  <p>ROUGH & TRIM PACKAGE</p> <table border="1"> <thead> <tr><th>CD</th></tr> </thead> <tbody> <tr><td>805</td></tr> </tbody> </table> <p>TRIM ONLY</p> <p>T26-9560-03-xx</p> <table border="1"> <thead> <tr><th>CD</th></tr> </thead> <tbody> <tr><td>424</td></tr> </tbody> </table> </div>	CD	805	CD	424												
CC	KK	LL	BB																																																																																	
595	659	702	702																																																																																	
CC	KK	LL	BB																																																																																	
214	278	321	321																																																																																	
CC	KK	LL	BB																																																																																	
625	698	747	747																																																																																	
CC	KK	LL	BB																																																																																	
244	317	366	366																																																																																	
CC	KK	LL	BB																																																																																	
668	754	812	812																																																																																	
CC	KK	LL	BB																																																																																	
287	373	431	431																																																																																	
CC/CB	KK/KB	LL/LB	BB																																																																																	
668	754	812	812																																																																																	
CC/CB	KK/KB	LL/LB	BB																																																																																	
287	373	431	431																																																																																	
CD																																																																																				
805																																																																																				
CD																																																																																				
424																																																																																				
<div style="border: 1px solid black; padding: 5px;"> <p>B27-9560-03-xx</p> <p>HAÜS-C</p>  <p>ROUGH & TRIM PACKAGE</p> <table border="1"> <thead> <tr><th>CC</th><th>KK</th><th>LL</th><th>BB</th></tr> </thead> <tbody> <tr><td>668</td><td>754</td><td>812</td><td>812</td></tr> </tbody> </table> <p>TRIM ONLY</p> <p>T27-9560-03-xx</p> <table border="1"> <thead> <tr><th>CC</th><th>KK</th><th>LL</th><th>BB</th></tr> </thead> <tbody> <tr><td>287</td><td>373</td><td>431</td><td>431</td></tr> </tbody> </table> </div>	CC	KK	LL	BB	668	754	812	812	CC	KK	LL	BB	287	373	431	431	<div style="border: 1px solid black; padding: 5px;"> <p>B28-9560-03-xx</p> <p>HAÜS-L</p>  <p>ROUGH & TRIM PACKAGE</p> <table border="1"> <thead> <tr><th>CC</th><th>KK</th><th>LL</th><th>BB</th></tr> </thead> <tbody> <tr><td>668</td><td>754</td><td>812</td><td>812</td></tr> </tbody> </table> <p>TRIM ONLY</p> <p>T28-9560-03-xx</p> <table border="1"> <thead> <tr><th>CC</th><th>KK</th><th>LL</th><th>BB</th></tr> </thead> <tbody> <tr><td>287</td><td>373</td><td>431</td><td>431</td></tr> </tbody> </table> </div>	CC	KK	LL	BB	668	754	812	812	CC	KK	LL	BB	287	373	431	431	<div style="border: 1px solid black; padding: 5px;"> <p>B45-9560-03-xx</p> <p>SENS</p>  <p>ROUGH & TRIM PACKAGE</p> <table border="1"> <thead> <tr><th>CC</th><th>KK</th><th>LL</th><th>BB</th></tr> </thead> <tbody> <tr><td>580</td><td>640</td><td>680</td><td>680</td></tr> </tbody> </table> <p>TRIM ONLY</p> <p>T45-9560-03-xx</p> <table border="1"> <thead> <tr><th>CC</th><th>KK</th><th>LL</th><th>BB</th></tr> </thead> <tbody> <tr><td>199</td><td>259</td><td>299</td><td>299</td></tr> </tbody> </table> </div>	CC	KK	LL	BB	580	640	680	680	CC	KK	LL	BB	199	259	299	299	<div style="border: 1px solid black; padding: 5px;"> <p>B46-9560-03-xx</p> <p>PROFILE</p>  <p>ROUGH & TRIM PACKAGE</p> <table border="1"> <thead> <tr><th>CC</th><th>KK</th><th>LL</th><th>BB</th></tr> </thead> <tbody> <tr><td>595</td><td>659</td><td>702</td><td>702</td></tr> </tbody> </table> <p>TRIM ONLY</p> <p>T46-9560-03-xx</p> <table border="1"> <thead> <tr><th>CC</th><th>KK</th><th>LL</th><th>BB</th></tr> </thead> <tbody> <tr><td>214</td><td>278</td><td>321</td><td>321</td></tr> </tbody> </table> </div>	CC	KK	LL	BB	595	659	702	702	CC	KK	LL	BB	214	278	321	321	<div style="border: 1px solid black; padding: 5px;"> <p>B47-9560-03-xx</p> <p>FLORA</p>  <p>ROUGH & TRIM PACKAGE</p> <table border="1"> <thead> <tr><th>Cx</th><th>Kx</th><th>Lx</th><th>Bx</th></tr> </thead> <tbody> <tr><td>698</td><td>793</td><td>857</td><td>857</td></tr> </tbody> </table> <p>TRIM ONLY</p> <p>T47-9560-03-xx</p> <table border="1"> <thead> <tr><th>Cx</th><th>Kx</th><th>Lx</th><th>Bx</th></tr> </thead> <tbody> <tr><td>317</td><td>412</td><td>476</td><td>476</td></tr> </tbody> </table> </div>	Cx	Kx	Lx	Bx	698	793	857	857	Cx	Kx	Lx	Bx	317	412	476	476
CC	KK	LL	BB																																																																																	
668	754	812	812																																																																																	
CC	KK	LL	BB																																																																																	
287	373	431	431																																																																																	
CC	KK	LL	BB																																																																																	
668	754	812	812																																																																																	
CC	KK	LL	BB																																																																																	
287	373	431	431																																																																																	
CC	KK	LL	BB																																																																																	
580	640	680	680																																																																																	
CC	KK	LL	BB																																																																																	
199	259	299	299																																																																																	
CC	KK	LL	BB																																																																																	
595	659	702	702																																																																																	
CC	KK	LL	BB																																																																																	
214	278	321	321																																																																																	
Cx	Kx	Lx	Bx																																																																																	
698	793	857	857																																																																																	
Cx	Kx	Lx	Bx																																																																																	
317	412	476	476																																																																																	
<div style="border: 1px solid black; padding: 5px;"> <p>B56-9560-03-xx</p> <p>ACCENT</p>  <p>ROUGH & TRIM PACKAGE</p> <table border="1"> <thead> <tr><th>CC</th><th>CB</th><th>CF</th></tr> </thead> <tbody> <tr><td>678</td><td>678</td><td>678</td></tr> </tbody> </table> <p>TRIM ONLY</p> <p>T56-9560-03-xx</p> <table border="1"> <thead> <tr><th>CC</th><th>CB</th><th>CF</th></tr> </thead> <tbody> <tr><td>297</td><td>297</td><td>297</td></tr> </tbody> </table> </div>	CC	CB	CF	678	678	678	CC	CB	CF	297	297	297	<div style="border: 1px solid black; padding: 5px;"> <p>B66-9560-03-xx</p> <p>ZIP</p>  <p>ROUGH & TRIM PACKAGE</p> <table border="1"> <thead> <tr><th>CC</th><th>KK</th><th>LL</th><th>BB</th></tr> </thead> <tbody> <tr><td>569</td><td>625</td><td>663</td><td>663</td></tr> </tbody> </table> <p>TRIM ONLY</p> <p>T66-9560-03-xx</p> <table border="1"> <thead> <tr><th>CC</th><th>KK</th><th>LL</th><th>BB</th></tr> </thead> <tbody> <tr><td>188</td><td>244</td><td>282</td><td>282</td></tr> </tbody> </table> </div>	CC	KK	LL	BB	569	625	663	663	CC	KK	LL	BB	188	244	282	282	<div style="border: 1px solid black; padding: 5px;"> <p>B71-9560-03-xx</p> <p>EVA</p>  <p>ROUGH & TRIM PACKAGE</p> <table border="1"> <thead> <tr><th>CC</th><th>KK</th><th>LL</th><th>BB</th></tr> </thead> <tbody> <tr><td>668</td><td>754</td><td>812</td><td>812</td></tr> </tbody> </table> <p>TRIM ONLY</p> <p>T71-9560-03-xx</p> <table border="1"> <thead> <tr><th>CC</th><th>KK</th><th>LL</th><th>BB</th></tr> </thead> <tbody> <tr><td>287</td><td>373</td><td>431</td><td>431</td></tr> </tbody> </table> </div>	CC	KK	LL	BB	668	754	812	812	CC	KK	LL	BB	287	373	431	431	<div style="border: 1px solid black; padding: 5px;"> <p>B72-9560-03-xx</p> <p>TRADITION</p>  <p>ROUGH & TRIM PACKAGE</p> <table border="1"> <thead> <tr><th>CC</th><th>KK</th><th>LL</th><th>BB</th></tr> </thead> <tbody> <tr><td>668</td><td>754</td><td>812</td><td>812</td></tr> </tbody> </table> <p>TRIM ONLY</p> <p>T72-9560-03-xx</p> <table border="1"> <thead> <tr><th>CC</th><th>KK</th><th>LL</th><th>BB</th></tr> </thead> <tbody> <tr><td>287</td><td>373</td><td>431</td><td>431</td></tr> </tbody> </table> </div>	CC	KK	LL	BB	668	754	812	812	CC	KK	LL	BB	287	373	431	431	<div style="border: 1px solid black; padding: 5px;"> <p>B74-9560-03-xx</p> <p>VICTOIRE</p>  <p>ROUGH & TRIM PACKAGE</p> <table border="1"> <thead> <tr><th>CB</th><th>KB</th><th>LB</th><th>BB</th></tr> </thead> <tbody> <tr><td>668</td><td>754</td><td>812</td><td>812</td></tr> </tbody> </table> <p>TRIM ONLY</p> <p>T74-9560-03-xx</p> <table border="1"> <thead> <tr><th>CB</th><th>KB</th><th>LB</th><th>BB</th></tr> </thead> <tbody> <tr><td>287</td><td>373</td><td>431</td><td>431</td></tr> </tbody> </table> </div>	CB	KB	LB	BB	668	754	812	812	CB	KB	LB	BB	287	373	431	431				
CC	CB	CF																																																																																		
678	678	678																																																																																		
CC	CB	CF																																																																																		
297	297	297																																																																																		
CC	KK	LL	BB																																																																																	
569	625	663	663																																																																																	
CC	KK	LL	BB																																																																																	
188	244	282	282																																																																																	
CC	KK	LL	BB																																																																																	
668	754	812	812																																																																																	
CC	KK	LL	BB																																																																																	
287	373	431	431																																																																																	
CC	KK	LL	BB																																																																																	
668	754	812	812																																																																																	
CC	KK	LL	BB																																																																																	
287	373	431	431																																																																																	
CB	KB	LB	BB																																																																																	
668	754	812	812																																																																																	
CB	KB	LB	BB																																																																																	
287	373	431	431																																																																																	

Actual products may differ from pictures. Actual products measures may differ from the measures shown. All USD prices are subject to change without notice. Effective as of August 2023.

RVA-9563-00-B



3-port diverter rough valve with off (shared port)

- A- 1 outlet: 9.7 gpm - 60 psi, 2 outlets: 5.2 gpm - 60 psi
- B- Can replace 3 volume control valves
- C- Up to 2 accessories can be used at the same time
- D- CAR-9530-03
- E- Extra long cartridge for maximum adjustment
- F- Inlet: 3/4" F NPT - outlets: 1/2" F NPT

RVA-9563-00-B

3-port diverter rough (shared port) - inlet: 3/4" F NPT - outlets: 1/2" F NPT

381

B80-9560-03-xx

AIR

Available
Q3 2023



VALVE WITHOUT HANDLE

CC	KK	LL	BB
481	511	531	531

TRIM (WITHOUT HANDLE)

T80-9560-03-xx

CC	KK	LL	BB
100	130	150	150

Finishes:

CC = chrome, CD = chrome diamond, CF = smokey chrome, KK = matte black, LL = satin brass, BB = white, NN = brushed nickel, YY = polished nickel, TT = venetian bronze, VV = satin copper, GG = gold, KM = black titanium, CB = chrome white, KB = matte black white, LB = satin brass white, NB = brushed nickel white, YB = polished nickel white, TB = venetian bronze, VB = satin copper white, GB = gold white

SHOWER VALVES

3-PORT DIVERTER

RVA-9563-00-NS-B



3-port diverter rough valve with off (non-shared port)

- A- 9.7 gpm - 60 psi
- B- Can replace 3 volume control valves
- C- 1 accessory works at a time
- D- CAR-9530-03-NS
- E- Extra long cartridge for maximum adjustment
- F- Inlet: 3/4" F NPT - outlets: 1/2" F NPT

RVA-9563-00-NS-B 3-port diverter rough (non-shared port) - inlet: 3/4" F NPT - outlets: 1/2" F NPT

381

B04-9560-03-xx-NS

PETITE

ROUGH & TRIM PACKAGE

CC	KK	LL	BB
595	659	702	702

TRIM ONLY

T04-9560-03-xx

CC	KK	LL	BB
214	278	321	321

B05-9560-03-xx-NS

REC

ROUGH & TRIM PACKAGE

CC	KK	LL	BB
625	698	747	747

TRIM ONLY

T05-9560-03-xx

CC	KK	LL	BB
244	317	366	366

B16-9560-03-xx-NS

NAUTICA

ROUGH & TRIM PACKAGE

CC	KK	LL	BB
668	754	812	812

TRIM ONLY

T16-9560-03-xx

CC	KK	LL	BB
287	373	431	431

B18-9560-03-xx-NS

RALPH

ROUGH & TRIM PACKAGE

CC/CB	KK/KB	LL/LB	BB
668	754	812	812

TRIM ONLY

T18-9560-03-xx

CC/CB	KK/KB	LL/LB	BB
287	373	431	431

B26-9560-03-xx-NS

HAÜS-D

ROUGH & TRIM PACKAGE

CD
805

TRIM ONLY

T26-9560-03-xx

CD
424

B27-9560-03-xx-NS

HAÜS-C

ROUGH & TRIM PACKAGE

CC	KK	LL	BB
668	754	812	812

TRIM ONLY

T27-9560-03-xx

CC	KK	LL	BB
287	373	431	431

B28-9560-03-xx-NS

HAÜS-L

ROUGH & TRIM PACKAGE

CC	KK	LL	BB
668	754	812	812

TRIM ONLY

T28-9560-03-xx

CC	KK	LL	BB
287	373	431	431

B45-9560-03-xx-NS

SENS

ROUGH & TRIM PACKAGE

CC	KK	LL	BB
580	640	680	680

TRIM ONLY

T45-9560-03-xx

CC	KK	LL	BB
199	259	299	299

B46-9560-03-xx-NS

PROFILE

ROUGH & TRIM PACKAGE

CC	KK	LL	BB
595	659	702	702

TRIM ONLY

T46-9560-03-xx

CC	KK	LL	BB
214	278	321	321

B47-9560-03-xx-NS

FLORA

ROUGH & TRIM PACKAGE

Cx	Kx	Lx	Bx
698	793	857	857

TRIM ONLY

T47-9560-03-xx

Cx	Kx	Lx	Bx
317	412	476	476

B56-9560-03-xx-NS

ACCENT

ROUGH & TRIM PACKAGE

CC	CB	CF
678	678	678

TRIM ONLY

T56-9560-03-xx

CC	CB	CF
297	297	297

B66-9560-03-xx-NS

ZIP

ROUGH & TRIM PACKAGE

CC	KK	LL	BB
569	625	663	663

TRIM ONLY

T66-9560-03-xx

CC	KK	LL	BB
188	244	282	282

B71-9560-03-xx-NS

EVA

ROUGH & TRIM PACKAGE

CC	KK	LL	BB
668	754	812	812

TRIM ONLY

T71-9560-03-xx

CC	KK	LL	BB
287	373	431	431

B72-9560-03-xx-NS

TRADITION

ROUGH & TRIM PACKAGE

CC	KK	LL	BB
668	754	812	812

TRIM ONLY

T72-9560-03-xx

CC	KK	LL	BB
287	373	431	431

B74-9560-03-xx-NS

VICTOIRE

ROUGH & TRIM PACKAGE

CB	KB	LB	BB
668	754	812	812

TRIM ONLY

T74-9560-03-xx

CB	KB	LB	BB
287	373	431	431

RVA-9563-00-NS-B

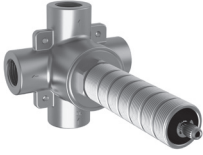

3-port diverter rough valve with off (non-shared port)

- A- 9.7 gpm - 60 psi
- B- Can replace 3 volume control valves
- C- 1 accessory works at a time
- D- CAR-9530-03-NS
- E- Extra long cartridge for maximum adjustment
- F- Inlet: 3/4" F NPT - outlets: 1/2" F NPT

RVA-9563-00-NS-B 3-port diverter rough (non-shared port) - inlet: 3/4" F NPT - outlets: 1/2" F NPT

381

B80-9560-03-xx-NS

AIR

Available Q3 2023



VALVE WITHOUT HANDLE

CC	KK	LL	BB
481	511	531	531

TRIM (WITHOUT HANDLE)

T80-9560-03-xx

CC	KK	LL	BB
100	130	150	150

Finishes:

CC = chrome, CD = chrome diamond, CF = smokey chrome, KK = matte black, LL = satin brass, BB = white, NN = brushed nickel, YY = polished nickel, TT = venetian bronze, VV = satin copper, GG = gold, KM = black titanium, CB = chrome white, KB = matte black white, LB = satin brass white, NB = brushed nickel white, YB = polished nickel white, TB = venetian bronze, VB = satin copper white, GB = gold white

SHOWER VALVES

1/2" VOLUME CONTROL VALVE

RVA-2020-01-B

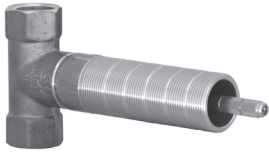













1/2" volume control valve rough

- A- 7.9 gpm - 60 psi
- B- On/off volume control rough valve
- C- CAR-1011-81
- D- Extra long cartridge for maximum adjustment
- E- 1/2" female NPT connections
- F- Extension may be cut to the length required
- G- Counterclockwise opening

RVA-2020-01-B

Volume control valve rough - 1/2" female NPT connections

174

<p>B05-9600-00-xx</p> <p>REC</p>  <p>ROUGH & TRIM PACKAGE</p> <table border="1"> <thead> <tr> <th>CC</th> <th>KK</th> <th>LL</th> <th>BB</th> </tr> </thead> <tbody> <tr> <td>418</td> <td>491</td> <td>540</td> <td>540</td> </tr> </tbody> </table> <p>TRIM ONLY</p> <p>T05-9600-00-xx</p> <table border="1"> <thead> <tr> <th>CC</th> <th>KK</th> <th>LL</th> <th>BB</th> </tr> </thead> <tbody> <tr> <td>244</td> <td>317</td> <td>366</td> <td>366</td> </tr> </tbody> </table>	CC	KK	LL	BB	418	491	540	540	CC	KK	LL	BB	244	317	366	366	<p>B16-9601-00-xx</p> <p>NAUTICA</p>  <p>ROUGH & TRIM PACKAGE</p> <table border="1"> <thead> <tr> <th>CC</th> <th>KK</th> <th>LL</th> <th>BB</th> </tr> </thead> <tbody> <tr> <td>461</td> <td>547</td> <td>605</td> <td>605</td> </tr> </tbody> </table> <p>TRIM ONLY</p> <p>T16-9601-00-xx</p> <table border="1"> <thead> <tr> <th>CC</th> <th>KK</th> <th>LL</th> <th>BB</th> </tr> </thead> <tbody> <tr> <td>287</td> <td>373</td> <td>431</td> <td>431</td> </tr> </tbody> </table>	CC	KK	LL	BB	461	547	605	605	CC	KK	LL	BB	287	373	431	431	<p>B18-9601-00-xx</p> <p>RALPH</p>  <p>ROUGH & TRIM PACKAGE</p> <table border="1"> <thead> <tr> <th>CC/CB</th> <th>KK/KB</th> <th>LL/LB</th> <th>BB</th> </tr> </thead> <tbody> <tr> <td>461</td> <td>547</td> <td>605</td> <td>605</td> </tr> </tbody> </table> <p>TRIM ONLY</p> <p>T18-9601-00-xx</p> <table border="1"> <thead> <tr> <th>CC/CB</th> <th>KK/KB</th> <th>LL/LB</th> <th>BB</th> </tr> </thead> <tbody> <tr> <td>287</td> <td>373</td> <td>431</td> <td>431</td> </tr> </tbody> </table>	CC/CB	KK/KB	LL/LB	BB	461	547	605	605	CC/CB	KK/KB	LL/LB	BB	287	373	431	431	<p>B26-9600-00-xx</p> <p>HAÜS-D</p>  <p>ROUGH & TRIM PACKAGE</p> <table border="1"> <thead> <tr> <th>CD</th> </tr> </thead> <tbody> <tr> <td>598</td> </tr> </tbody> </table> <p>TRIM ONLY</p> <p>T26-9600-00-xx</p> <table border="1"> <thead> <tr> <th>CD</th> </tr> </thead> <tbody> <tr> <td>424</td> </tr> </tbody> </table>	CD	598	CD	424	<p>B27-9600-00-xx</p> <p>HAÜS-C</p>  <p>ROUGH & TRIM PACKAGE</p> <table border="1"> <thead> <tr> <th>CC</th> <th>KK</th> <th>LL</th> <th>BB</th> </tr> </thead> <tbody> <tr> <td>461</td> <td>547</td> <td>605</td> <td>605</td> </tr> </tbody> </table> <p>TRIM ONLY</p> <p>T27-9600-00-xx</p> <table border="1"> <thead> <tr> <th>CC</th> <th>KK</th> <th>LL</th> <th>BB</th> </tr> </thead> <tbody> <tr> <td>287</td> <td>373</td> <td>431</td> <td>431</td> </tr> </tbody> </table>	CC	KK	LL	BB	461	547	605	605	CC	KK	LL	BB	287	373	431	431												
CC	KK	LL	BB																																																																																	
418	491	540	540																																																																																	
CC	KK	LL	BB																																																																																	
244	317	366	366																																																																																	
CC	KK	LL	BB																																																																																	
461	547	605	605																																																																																	
CC	KK	LL	BB																																																																																	
287	373	431	431																																																																																	
CC/CB	KK/KB	LL/LB	BB																																																																																	
461	547	605	605																																																																																	
CC/CB	KK/KB	LL/LB	BB																																																																																	
287	373	431	431																																																																																	
CD																																																																																				
598																																																																																				
CD																																																																																				
424																																																																																				
CC	KK	LL	BB																																																																																	
461	547	605	605																																																																																	
CC	KK	LL	BB																																																																																	
287	373	431	431																																																																																	
<p>B28-9600-00-xx</p> <p>HAÜS-L</p>  <p>ROUGH & TRIM PACKAGE</p> <table border="1"> <thead> <tr> <th>CC</th> <th>KK</th> <th>LL</th> <th>BB</th> </tr> </thead> <tbody> <tr> <td>461</td> <td>547</td> <td>605</td> <td>605</td> </tr> </tbody> </table> <p>TRIM ONLY</p> <p>T28-9600-00-xx</p> <table border="1"> <thead> <tr> <th>CC</th> <th>KK</th> <th>LL</th> <th>BB</th> </tr> </thead> <tbody> <tr> <td>287</td> <td>373</td> <td>431</td> <td>431</td> </tr> </tbody> </table>	CC	KK	LL	BB	461	547	605	605	CC	KK	LL	BB	287	373	431	431	<p>B45-9600-00-xx</p> <p>SENS</p>  <p>ROUGH & TRIM PACKAGE</p> <table border="1"> <thead> <tr> <th>CC</th> <th>KK</th> <th>LL</th> <th>BB</th> </tr> </thead> <tbody> <tr> <td>373</td> <td>433</td> <td>473</td> <td>473</td> </tr> </tbody> </table> <p>TRIM ONLY</p> <p>T45-9600-00-xx</p> <table border="1"> <thead> <tr> <th>CC</th> <th>KK</th> <th>LL</th> <th>BB</th> </tr> </thead> <tbody> <tr> <td>199</td> <td>259</td> <td>299</td> <td>299</td> </tr> </tbody> </table>	CC	KK	LL	BB	373	433	473	473	CC	KK	LL	BB	199	259	299	299	<p>B47-9600-00-xx</p> <p>FLORA</p>  <p>ROUGH & TRIM PACKAGE</p> <table border="1"> <thead> <tr> <th>Cx</th> <th>Kx</th> <th>Lx</th> <th>Bx</th> </tr> </thead> <tbody> <tr> <td>491</td> <td>586</td> <td>650</td> <td>650</td> </tr> </tbody> </table> <p>TRIM ONLY</p> <p>T47-9600-00-xx</p> <table border="1"> <thead> <tr> <th>Cx</th> <th>Kx</th> <th>Lx</th> <th>Bx</th> </tr> </thead> <tbody> <tr> <td>317</td> <td>412</td> <td>476</td> <td>476</td> </tr> </tbody> </table>	Cx	Kx	Lx	Bx	491	586	650	650	Cx	Kx	Lx	Bx	317	412	476	476	<p>B66-9600-00-xx</p> <p>ZIP</p>  <p>ROUGH & TRIM PACKAGE</p> <table border="1"> <thead> <tr> <th>CC</th> <th>KK</th> <th>LL</th> <th>BB</th> </tr> </thead> <tbody> <tr> <td>362</td> <td>418</td> <td>456</td> <td>456</td> </tr> </tbody> </table> <p>TRIM ONLY</p> <p>T66-9600-00-xx</p> <table border="1"> <thead> <tr> <th>CC</th> <th>KK</th> <th>LL</th> <th>BB</th> </tr> </thead> <tbody> <tr> <td>188</td> <td>244</td> <td>282</td> <td>282</td> </tr> </tbody> </table>	CC	KK	LL	BB	362	418	456	456	CC	KK	LL	BB	188	244	282	282	<p>B71-9601-00-xx</p> <p>EVA</p>  <p>ROUGH & TRIM PACKAGE</p> <table border="1"> <thead> <tr> <th>CC</th> <th>KK</th> <th>LL</th> <th>BB</th> </tr> </thead> <tbody> <tr> <td>461</td> <td>547</td> <td>605</td> <td>605</td> </tr> </tbody> </table> <p>TRIM ONLY</p> <p>T71-9601-00-xx</p> <table border="1"> <thead> <tr> <th>CC</th> <th>KK</th> <th>LL</th> <th>BB</th> </tr> </thead> <tbody> <tr> <td>287</td> <td>373</td> <td>431</td> <td>431</td> </tr> </tbody> </table>	CC	KK	LL	BB	461	547	605	605	CC	KK	LL	BB	287	373	431	431
CC	KK	LL	BB																																																																																	
461	547	605	605																																																																																	
CC	KK	LL	BB																																																																																	
287	373	431	431																																																																																	
CC	KK	LL	BB																																																																																	
373	433	473	473																																																																																	
CC	KK	LL	BB																																																																																	
199	259	299	299																																																																																	
Cx	Kx	Lx	Bx																																																																																	
491	586	650	650																																																																																	
Cx	Kx	Lx	Bx																																																																																	
317	412	476	476																																																																																	
CC	KK	LL	BB																																																																																	
362	418	456	456																																																																																	
CC	KK	LL	BB																																																																																	
188	244	282	282																																																																																	
CC	KK	LL	BB																																																																																	
461	547	605	605																																																																																	
CC	KK	LL	BB																																																																																	
287	373	431	431																																																																																	
<p>B72-9601-00-xx</p> <p>TRADITION</p>  <p>ROUGH & TRIM PACKAGE</p> <table border="1"> <thead> <tr> <th>CC</th> <th>KK</th> <th>LL</th> <th>BB</th> </tr> </thead> <tbody> <tr> <td>461</td> <td>547</td> <td>605</td> <td>605</td> </tr> </tbody> </table> <p>TRIM ONLY</p> <p>T72-9601-00-xx</p> <table border="1"> <thead> <tr> <th>CC</th> <th>KK</th> <th>LL</th> <th>BB</th> </tr> </thead> <tbody> <tr> <td>287</td> <td>373</td> <td>431</td> <td>431</td> </tr> </tbody> </table>	CC	KK	LL	BB	461	547	605	605	CC	KK	LL	BB	287	373	431	431	<p>B74-9601-00-xx</p> <p>VICTOIRE</p>  <p>ROUGH & TRIM PACKAGE</p> <table border="1"> <thead> <tr> <th>CB</th> <th>KB</th> <th>LB</th> <th>BB</th> </tr> </thead> <tbody> <tr> <td>461</td> <td>547</td> <td>605</td> <td>605</td> </tr> </tbody> </table> <p>TRIM ONLY</p> <p>T74-9601-00-xx</p> <table border="1"> <thead> <tr> <th>CB</th> <th>KB</th> <th>LB</th> <th>BB</th> </tr> </thead> <tbody> <tr> <td>287</td> <td>373</td> <td>431</td> <td>431</td> </tr> </tbody> </table>	CB	KB	LB	BB	461	547	605	605	CB	KB	LB	BB	287	373	431	431																																																			
CC	KK	LL	BB																																																																																	
461	547	605	605																																																																																	
CC	KK	LL	BB																																																																																	
287	373	431	431																																																																																	
CB	KB	LB	BB																																																																																	
461	547	605	605																																																																																	
CB	KB	LB	BB																																																																																	
287	373	431	431																																																																																	

Actual products may differ from pictures. Actual products measures may differ from the measures shown. All USD prices are subject to change without notice. Effective as of August 2023.

SHOWER VALVES

3/4" VOLUME CONTROL VALVE

RVA-2719-34-B

















3/4" volume control valve rough

- A- 11.1 gpm - 60 psi
- B- On/off volume control rough valve
- C- Offers higher flow
- D- CAR-2719-34
- E- Extra long cartridge for maximum adjustment
- F- 3/4" female NPT connections
- G- Extension may be cut to the length required
- H- Counterclockwise opening

RVA-2719-34-B

Volume control valve rough - 3/4" female NPT connections

235

<p>B04-9649-00-xx</p> <p>PETITE</p>  <p>ROUGH & TRIM PACKAGE</p> <table border="1"> <thead> <tr> <th>CC</th> <th>KK</th> <th>LL</th> <th>BB</th> </tr> </thead> <tbody> <tr> <td>449</td> <td>513</td> <td>556</td> <td>556</td> </tr> </tbody> </table> <p>TRIM ONLY</p> <p>T04-9649-00-xx</p> <table border="1"> <thead> <tr> <th>CC</th> <th>KK</th> <th>LL</th> <th>BB</th> </tr> </thead> <tbody> <tr> <td>214</td> <td>278</td> <td>321</td> <td>321</td> </tr> </tbody> </table>	CC	KK	LL	BB	449	513	556	556	CC	KK	LL	BB	214	278	321	321	<p>B05-9649-00-xx</p> <p>REC</p>  <p>ROUGH & TRIM PACKAGE</p> <table border="1"> <thead> <tr> <th>CC</th> <th>KK</th> <th>LL</th> <th>BB</th> </tr> </thead> <tbody> <tr> <td>479</td> <td>552</td> <td>601</td> <td>601</td> </tr> </tbody> </table> <p>TRIM ONLY</p> <p>T05-9649-00-xx</p> <table border="1"> <thead> <tr> <th>CC</th> <th>KK</th> <th>LL</th> <th>BB</th> </tr> </thead> <tbody> <tr> <td>244</td> <td>317</td> <td>366</td> <td>366</td> </tr> </tbody> </table>	CC	KK	LL	BB	479	552	601	601	CC	KK	LL	BB	244	317	366	366	<p>B16-9641-00-xx</p> <p>NAUTICA</p>  <p>ROUGH & TRIM PACKAGE</p> <table border="1"> <thead> <tr> <th>CC</th> <th>KK</th> <th>LL</th> <th>BB</th> </tr> </thead> <tbody> <tr> <td>522</td> <td>608</td> <td>666</td> <td>666</td> </tr> </tbody> </table> <p>TRIM ONLY</p> <p>T16-9641-00-xx</p> <table border="1"> <thead> <tr> <th>CC</th> <th>KK</th> <th>LL</th> <th>BB</th> </tr> </thead> <tbody> <tr> <td>287</td> <td>373</td> <td>431</td> <td>431</td> </tr> </tbody> </table>	CC	KK	LL	BB	522	608	666	666	CC	KK	LL	BB	287	373	431	431	<p>B18-9641-00-xx</p> <p>RALPH</p>  <p>ROUGH & TRIM PACKAGE</p> <table border="1"> <thead> <tr> <th>CC/CB</th> <th>KK/KB</th> <th>LL/LB</th> <th>BB</th> </tr> </thead> <tbody> <tr> <td>522</td> <td>608</td> <td>666</td> <td>666</td> </tr> </tbody> </table> <p>TRIM ONLY</p> <p>T18-9641-00-xx</p> <table border="1"> <thead> <tr> <th>CC/CB</th> <th>KK/KB</th> <th>LL/LB</th> <th>BB</th> </tr> </thead> <tbody> <tr> <td>287</td> <td>373</td> <td>431</td> <td>431</td> </tr> </tbody> </table>	CC/CB	KK/KB	LL/LB	BB	522	608	666	666	CC/CB	KK/KB	LL/LB	BB	287	373	431	431	<p>B26-9640-00-xx</p> <p>HAÜS-D</p>  <p>ROUGH & TRIM PACKAGE</p> <table border="1"> <thead> <tr> <th>CD</th> </tr> </thead> <tbody> <tr> <td>659</td> </tr> </tbody> </table> <p>TRIM ONLY</p> <p>T26-9640-00-xx</p> <table border="1"> <thead> <tr> <th>CD</th> </tr> </thead> <tbody> <tr> <td>424</td> </tr> </tbody> </table>	CD	659	CD	424												
CC	KK	LL	BB																																																																																	
449	513	556	556																																																																																	
CC	KK	LL	BB																																																																																	
214	278	321	321																																																																																	
CC	KK	LL	BB																																																																																	
479	552	601	601																																																																																	
CC	KK	LL	BB																																																																																	
244	317	366	366																																																																																	
CC	KK	LL	BB																																																																																	
522	608	666	666																																																																																	
CC	KK	LL	BB																																																																																	
287	373	431	431																																																																																	
CC/CB	KK/KB	LL/LB	BB																																																																																	
522	608	666	666																																																																																	
CC/CB	KK/KB	LL/LB	BB																																																																																	
287	373	431	431																																																																																	
CD																																																																																				
659																																																																																				
CD																																																																																				
424																																																																																				
<p>B27-9640-00-xx</p> <p>HAÜS-C</p>  <p>ROUGH & TRIM PACKAGE</p> <table border="1"> <thead> <tr> <th>CC</th> <th>KK</th> <th>LL</th> <th>BB</th> </tr> </thead> <tbody> <tr> <td>522</td> <td>608</td> <td>666</td> <td>666</td> </tr> </tbody> </table> <p>TRIM ONLY</p> <p>T27-9640-00-xx</p> <table border="1"> <thead> <tr> <th>CC</th> <th>KK</th> <th>LL</th> <th>BB</th> </tr> </thead> <tbody> <tr> <td>287</td> <td>373</td> <td>431</td> <td>431</td> </tr> </tbody> </table>	CC	KK	LL	BB	522	608	666	666	CC	KK	LL	BB	287	373	431	431	<p>B28-9640-00-xx</p> <p>HAÜS-L</p>  <p>ROUGH & TRIM PACKAGE</p> <table border="1"> <thead> <tr> <th>CC</th> <th>KK</th> <th>LL</th> <th>BB</th> </tr> </thead> <tbody> <tr> <td>522</td> <td>608</td> <td>666</td> <td>666</td> </tr> </tbody> </table> <p>TRIM ONLY</p> <p>T28-9640-00-xx</p> <table border="1"> <thead> <tr> <th>CC</th> <th>KK</th> <th>LL</th> <th>BB</th> </tr> </thead> <tbody> <tr> <td>287</td> <td>373</td> <td>431</td> <td>431</td> </tr> </tbody> </table>	CC	KK	LL	BB	522	608	666	666	CC	KK	LL	BB	287	373	431	431	<p>B45-9649-00-xx</p> <p>SENS</p>  <p>ROUGH & TRIM PACKAGE</p> <table border="1"> <thead> <tr> <th>CC</th> <th>KK</th> <th>LL</th> <th>BB</th> </tr> </thead> <tbody> <tr> <td>434</td> <td>494</td> <td>534</td> <td>534</td> </tr> </tbody> </table> <p>TRIM ONLY</p> <p>T45-9649-00-xx</p> <table border="1"> <thead> <tr> <th>CC</th> <th>KK</th> <th>LL</th> <th>BB</th> </tr> </thead> <tbody> <tr> <td>199</td> <td>259</td> <td>299</td> <td>299</td> </tr> </tbody> </table>	CC	KK	LL	BB	434	494	534	534	CC	KK	LL	BB	199	259	299	299	<p>B46-9649-00-xx</p> <p>PROFILE</p>  <p>ROUGH & TRIM PACKAGE</p> <table border="1"> <thead> <tr> <th>CC</th> <th>KK</th> <th>LL</th> <th>BB</th> </tr> </thead> <tbody> <tr> <td>449</td> <td>513</td> <td>556</td> <td>556</td> </tr> </tbody> </table> <p>TRIM ONLY</p> <p>T46-9649-00-xx</p> <table border="1"> <thead> <tr> <th>CC</th> <th>KK</th> <th>LL</th> <th>BB</th> </tr> </thead> <tbody> <tr> <td>214</td> <td>278</td> <td>321</td> <td>321</td> </tr> </tbody> </table>	CC	KK	LL	BB	449	513	556	556	CC	KK	LL	BB	214	278	321	321	<p>B47-9649-00-xx</p> <p>FLORA</p>  <p>ROUGH & TRIM PACKAGE</p> <table border="1"> <thead> <tr> <th>Cx</th> <th>Kx</th> <th>Lx</th> <th>Bx</th> </tr> </thead> <tbody> <tr> <td>552</td> <td>647</td> <td>711</td> <td>711</td> </tr> </tbody> </table> <p>TRIM ONLY</p> <p>T47-9649-00-xx</p> <table border="1"> <thead> <tr> <th>Cx</th> <th>Kx</th> <th>Lx</th> <th>Bx</th> </tr> </thead> <tbody> <tr> <td>317</td> <td>412</td> <td>476</td> <td>476</td> </tr> </tbody> </table>	Cx	Kx	Lx	Bx	552	647	711	711	Cx	Kx	Lx	Bx	317	412	476	476
CC	KK	LL	BB																																																																																	
522	608	666	666																																																																																	
CC	KK	LL	BB																																																																																	
287	373	431	431																																																																																	
CC	KK	LL	BB																																																																																	
522	608	666	666																																																																																	
CC	KK	LL	BB																																																																																	
287	373	431	431																																																																																	
CC	KK	LL	BB																																																																																	
434	494	534	534																																																																																	
CC	KK	LL	BB																																																																																	
199	259	299	299																																																																																	
CC	KK	LL	BB																																																																																	
449	513	556	556																																																																																	
CC	KK	LL	BB																																																																																	
214	278	321	321																																																																																	
Cx	Kx	Lx	Bx																																																																																	
552	647	711	711																																																																																	
Cx	Kx	Lx	Bx																																																																																	
317	412	476	476																																																																																	
<p>B56-9649-00-xx</p> <p>ACCENT</p>  <p>ROUGH & TRIM PACKAGE</p> <table border="1"> <thead> <tr> <th>CC</th> <th>CB</th> <th>CF</th> </tr> </thead> <tbody> <tr> <td>532</td> <td>532</td> <td>532</td> </tr> </tbody> </table> <p>TRIM ONLY</p> <p>T56-9649-00-xx</p> <table border="1"> <thead> <tr> <th>CC</th> <th>CB</th> <th>CF</th> </tr> </thead> <tbody> <tr> <td>297</td> <td>297</td> <td>297</td> </tr> </tbody> </table>	CC	CB	CF	532	532	532	CC	CB	CF	297	297	297	<p>B66-9649-00-xx</p> <p>ZIP</p>  <p>ROUGH & TRIM PACKAGE</p> <table border="1"> <thead> <tr> <th>CC</th> <th>KK</th> <th>LL</th> <th>BB</th> </tr> </thead> <tbody> <tr> <td>423</td> <td>479</td> <td>517</td> <td>517</td> </tr> </tbody> </table> <p>TRIM ONLY</p> <p>T66-9649-00-xx</p> <table border="1"> <thead> <tr> <th>CC</th> <th>KK</th> <th>LL</th> <th>BB</th> </tr> </thead> <tbody> <tr> <td>188</td> <td>244</td> <td>282</td> <td>282</td> </tr> </tbody> </table>	CC	KK	LL	BB	423	479	517	517	CC	KK	LL	BB	188	244	282	282	<p>B71-9641-00-xx</p> <p>EVA</p>  <p>ROUGH & TRIM PACKAGE</p> <table border="1"> <thead> <tr> <th>CC</th> <th>KK</th> <th>LL</th> <th>BB</th> </tr> </thead> <tbody> <tr> <td>522</td> <td>608</td> <td>666</td> <td>666</td> </tr> </tbody> </table> <p>TRIM ONLY</p> <p>T71-9641-00-xx</p> <table border="1"> <thead> <tr> <th>CC</th> <th>KK</th> <th>LL</th> <th>BB</th> </tr> </thead> <tbody> <tr> <td>287</td> <td>373</td> <td>431</td> <td>431</td> </tr> </tbody> </table>	CC	KK	LL	BB	522	608	666	666	CC	KK	LL	BB	287	373	431	431	<p>B72-9641-00-xx</p> <p>TRADITION</p>  <p>ROUGH & TRIM PACKAGE</p> <table border="1"> <thead> <tr> <th>CC</th> <th>KK</th> <th>LL</th> <th>BB</th> </tr> </thead> <tbody> <tr> <td>522</td> <td>608</td> <td>666</td> <td>666</td> </tr> </tbody> </table> <p>TRIM ONLY</p> <p>T72-9641-00-xx</p> <table border="1"> <thead> <tr> <th>CC</th> <th>KK</th> <th>LL</th> <th>BB</th> </tr> </thead> <tbody> <tr> <td>287</td> <td>373</td> <td>431</td> <td>431</td> </tr> </tbody> </table>	CC	KK	LL	BB	522	608	666	666	CC	KK	LL	BB	287	373	431	431	<p>B74-9641-00-xx</p> <p>VICTOIRE</p>  <p>ROUGH & TRIM PACKAGE</p> <table border="1"> <thead> <tr> <th>CB</th> <th>KB</th> <th>LB</th> <th>BB</th> </tr> </thead> <tbody> <tr> <td>522</td> <td>608</td> <td>666</td> <td>666</td> </tr> </tbody> </table> <p>TRIM ONLY</p> <p>T74-9641-00-xx</p> <table border="1"> <thead> <tr> <th>CB</th> <th>KB</th> <th>LB</th> <th>BB</th> </tr> </thead> <tbody> <tr> <td>287</td> <td>373</td> <td>431</td> <td>431</td> </tr> </tbody> </table>	CB	KB	LB	BB	522	608	666	666	CB	KB	LB	BB	287	373	431	431				
CC	CB	CF																																																																																		
532	532	532																																																																																		
CC	CB	CF																																																																																		
297	297	297																																																																																		
CC	KK	LL	BB																																																																																	
423	479	517	517																																																																																	
CC	KK	LL	BB																																																																																	
188	244	282	282																																																																																	
CC	KK	LL	BB																																																																																	
522	608	666	666																																																																																	
CC	KK	LL	BB																																																																																	
287	373	431	431																																																																																	
CC	KK	LL	BB																																																																																	
522	608	666	666																																																																																	
CC	KK	LL	BB																																																																																	
287	373	431	431																																																																																	
CB	KB	LB	BB																																																																																	
522	608	666	666																																																																																	
CB	KB	LB	BB																																																																																	
287	373	431	431																																																																																	

Actual products may differ from pictures. Actual products measures may differ from the measures shown. All USD prices are subject to change without notice. Effective as of August 2023.

RVA-2719-34-B



3/4" volume control valve rough

- A- 11.1 gpm - 60 psi
- B- On/off volume control rough valve
- C- Offers higher flow
- D- CAR-2719-34
- E- Extra long cartridge for maximum adjustment
- F- 3/4" female NPT connections
- G- Extension may be cut to the length required
- H- Counterclockwise opening

RVA-2719-34-B

Volume control valve rough - 3/4" female NPT connections

235

B80-9649-00-xx

AIR

Available
Q3 2023



VALVE WITHOUT HANDLE

CC	KK	LL	BB
335	365	385	385

TRIM (WITHOUT HANDLE)

T80-9649-00-xx

CC	KK	LL	BB
100	130	150	150

Finishes:

CC = chrome, CD = chrome diamond, CF = smokey chrome, KK = matte black, LL = satin brass, BB = white, NN = brushed nickel, YY = polished nickel, TT = venetian bronze, VV = satin copper, GG = gold, KM = black titanium, CB = chrome white, KB = matte black white, LB = satin brass white, NB = brushed nickel white, YB = polished nickel white, TB = venetian bronze, VB = satin copper white, GB = gold white

SHOWER VALVES

WALL-MOUNT SUPPLY ELBOW WITH INTEGRATED VOLUME CONTROL

RAC-9201-02-xx



CC	KK	LL	BB
199	259	299	299

RAC-9402-14-xx



CC	KK	LL	BB
224	291	336	336

Wall-mount supply elbow with integrated volume control

- A- 6.9 gpm - 60 psi
- B- Volume control valve
- C- Can be used to replace a volume control valve and a wall-mount supply elbow
- D- CAR-1020-02

VAL-2615-01-xx

CC	NN
850	1104

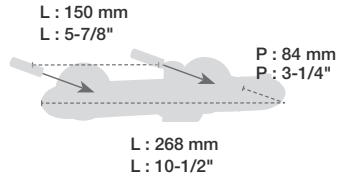

External thermostatic shower valve with spout

- A- 6.6 gpm - 60psi
- B- Volume cartridge: CAR-1020-02
- C- Thermostatic cartridge: CAR-2600-01
- D- Built-in bath spout
- E- To be paired with a sliding shower bar or a hand shower on wall-mounted supply elbow

VAL-2650-00-xx

CC	KK	LL	BB	NN/YY	VV/TT	GG
698	907	1047	1047	907	1117	1536

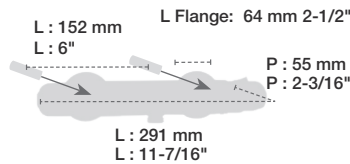

External thermostatic shower valve

- A- 5.4 gpm - 60 psi
- B- Volume cartridge: CAR-1020-02
- C- Thermostatic cartridge: CAR-2660-00
- D- Centred outlet
- E- To be paired with a sliding shower bar or a hand shower on wall-mounted supply elbow

Finishes:

CC = chrome, CD = chrome diamond, CF = smokey chrome, KK = matte black, LL = satin brass, BB = white, NN = brushed nickel, YY = polished nickel, TT = venetian bronze, VV = satin copper, GG = gold, KM = black titanium, CB = chrome white, KB = matte black white, LB = satin brass white, NB = brushed nickel white, YB = polished nickel white, TB = venetian bronze, VB = satin copper white, GB = gold white

SHOWER VALVES

COMPLETE SHOWER KIT ON COLUMN

PRO-1100-16-xx

Complete thermostatic shower kit on column

CC	KK	LL	BB	NN/YY	VV/TT	GG
2495	3244	3743	3743	3244	3992	5489



Features

- A- Max: 2 gpm - 80 psi (per accessory)
- B- 3-spray hand shower
- C- 2 accessories can work together
- D- Temperature handle on the hot water inlet side, allowing the surface temperature to never exceed the shower water temperature
- E- Shower head arm adjustable up to 20" in height
- F- Easy to move metal slider with built-in hook
- G- Thermostatic cartridge: CAR-2660-00
- H- Diverter cartridge: CAR-3003-36

Ecological options <small>CEC</small>	Code	Features are the same, except:
	PRO-1100-16-xx-NS	A- Max: 1.75 gpm - 80 psi (per accessory) C- 1 accessory works at a time H- Diverter cartridge: CAR-3003-36-NS

PRO-1100-53-xx

Complete thermostatic shower kit on column

CC	KK	LL	BB	NN/YY	VV/TT	GG
1775	2308	2663	2663	2308	2840	3905



Features

- A- Max: 2 gpm - 80 psi (per accessory)
- B- 3-spray push-button hand shower
- C- 2 accessories can work together
- D- Temperature handle on the hot water inlet side, allowing the surface temperature to never exceed the shower water temperature
- E- Shower head arm adjustable up to 20" in height
- F- Easy to move metal slider with built-in hook
- G- Thermostatic cartridge: CAR-2661-00
- H- Diverter cartridge: CAR-3003-36

Ecological options <small>CEC</small>	Code	Features are the same, except:
	PRO-1100-53-xx-NS	A- Max: 1.75 gpm - 80 psi (per accessory) C- 1 accessory works at a time H- Diverter cartridge: CAR-3003-36-NS

PRO-1100-71-xx

Complete thermostatic shower kit on column

CC	KK	LL	BB	NN/YY	VV/TT	GG
2495	3244	3743	3743	3244	3992	5489



Features

- A- Max: 2 gpm - 80 psi (per accessory)
- B- 2-spray hand shower
- C- 2 accessories can work together
- D- Temperature handle on the hot water inlet side, allowing the surface temperature to never exceed the shower water temperature
- E- Shower head arm adjustable up to 20" in height
- F- Easy to move metal slider with built-in hook
- G- Thermostatic cartridge: CAR-2660-00
- H- Diverter cartridge: CAR-3003-36

Ecological options <small>CEC</small>	Code	Features are the same, except:
	PRO-1100-71-xx-NS	A- Max: 1.75 gpm - 80 psi (per accessory) C- 1 accessory works at a time H- Diverter cartridge: CAR-3003-36-NS

PRO-1100-74-xx

Complete thermostatic shower kit on column

CC	KK	LL	BB	NN/YY	VV/TT	GG
2495	3244	3743	3743	3244	3992	5489



Features

- A- Max: 2 gpm - 80 psi (per accessory)
- B- 2-spray hand shower
- C- 2 accessories can work together
- D- Temperature handle on the hot water inlet side, allowing the surface temperature to never exceed the shower water temperature
- E- Shower head arm adjustable up to 20" in height
- F- Easy to move metal slider with built-in hook
- G- Thermostatic cartridge: CAR-2661-00
- H- Diverter cartridge: CAR-3003-36

Ecological options <small>CEC</small>	Code	Features are the same, except:
	PRO-1100-74-xx-NS	A- Max: 1.75 gpm - 80 psi (per accessory) C- 1 accessory works at a time H- Diverter cartridge: CAR-3003-36-NS

Actual products may differ from pictures. Actual products measures may differ from the measures shown. All USD prices are subject to change without notice. Effective as of August 2023.

PRO-1101-53-xx

Complete thermostatic shower kit on column

CC	KK	LL	BB	NN/YY	VV/TT	GG
1895	2464	2843	2843	2464	3032	4169

Available Q3 2023



Features

- A- Max: 2 gpm - 80 psi (per accessory)
- B- 3-spray push-button hand shower
- C- 2 accessories can work together
- D- Temperature handle on the hot water inlet side, allowing the surface temperature to never exceed the shower water temperature
- E- Shower head arm adjustable up to 20" in height
- F- Easy to move metal slider with built-in hook
- G- Thermostatic cartridge: CAR-2661-00
- H- Diverter cartridge: CAR-3003-36

Ecological options	CEC	Code	Features are the same, except:
		PRO-1101-53-xx-NS	A- Max: 1.75 gpm - 80 psi (per accessory) C- 1 accessory works at a time H- Diverter cartridge: CAR-3003-36-NS

PRO-1102-53-xx

Complete thermostatic shower kit on column

CC	KK	LL	BB	NN/YY	VV/TT	GG
1995	2594	2993	2993	2594	3192	4389

Available Q3 2023



Features

- A- Max: 2 gpm - 80 psi (per accessory)
- B- 3-spray push-button hand shower
- C- 2 accessories can work together
- D- Temperature handle on the hot water inlet side, allowing the surface temperature to never exceed the shower water temperature
- E- Shower head arm adjustable up to 20" in height
- F- Easy to move metal slider with built-in hook
- G- Thermostatic cartridge: CAR-2661-00
- H- Diverter cartridge: CAR-3003-36

Ecological options	CEC	Code	Features are the same, except:
		PRO-1102-53-xx-NS	A- Max: 1.75 gpm - 80 psi (per accessory) C- 1 accessory works at a time H- Diverter cartridge: CAR-3003-36-NS

PRO-1104-53-xx

Complete thermostatic shower kit on column

CC	KK	LL	BB	NN/YY	VV/TT	GG
1795	2334	2693	2693	2334	2872	3949



Features

- A- Max: 2 gpm - 80 psi (per accessory)
- B- 3-spray push-button hand shower
- C- 2 accessories can work together
- D- Temperature handle on the hot water inlet side, allowing the surface temperature to never exceed the shower water temperature
- E- Shower head arm adjustable up to 20" in height
- F- Easy to move metal slider with built-in hook
- G- Thermostatic cartridge: CAR-2661-00
- H- Diverter cartridge: CAR-3003-36

Ecological options	CEC	Code	Features are the same, except:
		PRO-1104-53-xx-NS	A- Max: 1.75 gpm - 80 psi (per accessory) C- 1 accessory works at a time H- Diverter cartridge: CAR-3003-36-NS

PRO-1401-03-xx

Complete thermostatic shower kit on square column

CC	KK	LL	BB	NN/YY	VV/TT	GG
2245	2919	3368	3368	2919	3592	4939



Features

- A- Max: 2 gpm - 80 psi (per accessory)
- B- 3-spray hand shower
- C- 2 accessories can work together
- D- Temperature handle on the hot water inlet side, allowing the surface temperature to never exceed the shower water temperature
- E- Shower head arm adjustable up to 20" in height
- F- Thermostatic cartridge: CAR-2661-00
- G- Diverter cartridge: CAR-3003-36

Ecological options	CEC	Code	Features are the same, except:
		PRO-1401-03-xx-NS	A- Max: 1.75 gpm - 80 psi (per accessory) C- 1 accessory works at a time G- Diverter cartridge: CAR-3003-36-NS

Finishes:

CC = chrome, KK = matte black, LL = satin brass, BB = white, NN = brushed nickel, YY = polished nickel, TT = venetian bronze, VV = satin copper, GG = gold

Compo- nents

BARIL

COMPONENTS

HAND SHOWER ON WALL-MOUNTED SUPPLY ELBOW

DSP-2555-20-xx

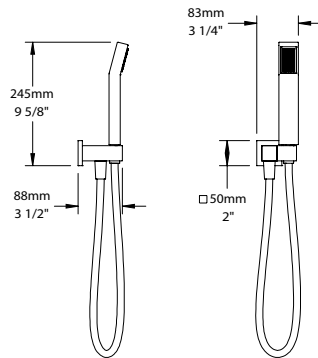

CC	KK	LL	BB	NN/YY	VV/TT	GG
436	567	654	654	567	697	959

1-spray anti-limestone hand shower on wall-mounted supply elbow

Hand shower:

- A- Single spray pattern
- B- Easy-to-clean silicone nozzles
- C- 2 gpm - 80 psi
- D- DOU-2555-01-xx

Wall-mounted supply elbow:

- E- 1/2" F connection
- F- Brass elbow
- G- RAC-9001-20-xx

Hose:

- H- Conical nut 1/2" female
- I- 59" (150 cm) double interlock flexible hose, rotating nut with 2 non-return valves
- J- PVC hose in KK finish or brass for other finishes

Ecological options

Codes	Reduced flow rates
DSP-2555-20-xx-150	1.5 gpm (5.7 l/min) - 80 psi
DSP-2555-20-xx-175	1.75 gpm (6.6 l/min) - 80 psi

CEC

DSP-2561-19-xx

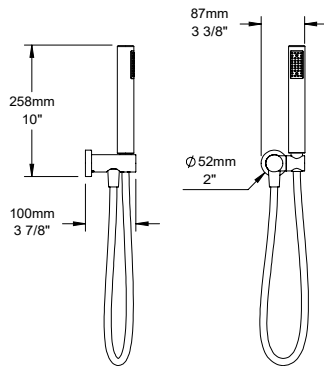

CC	KK
369	480

1-spray anti-limestone hand shower on wall-mounted supply elbow

Hand shower:

- A- Single spray pattern
- B- Easy-to-clean silicone nozzles
- C- 2 gpm - 80 psi
- D- DOU-2561-01-xx

Wall-mounted supply elbow:

- E- 1/2" F connection
- F- Brass elbow
- G- RAC-9001-19-xx

Hose:

- H- Conical nut 1/2" female
- I- 59" (150 cm) double interlock flexible hose, rotating nut with 2 non-return valves
- J- PVC hose in KK finish or brass for other finishes

Ecological options

Codes	Reduced flow rates
DSP-2561-19-xx-150	1.5 gpm (5.7 l/min) - 80 psi
DSP-2561-19-xx-175	1.75 gpm (6.6 l/min) - 80 psi

CEC

DSP-2566-19-xx

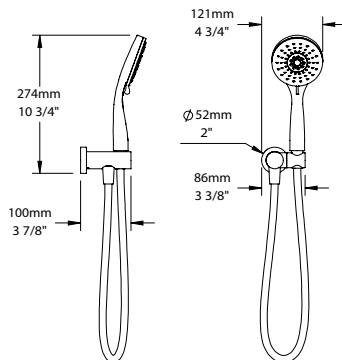

CC	KK	LL	BB	NN/YY	VV/TT	GG
423	550	635	635	550	676	931

3-spray anti-limestone hand shower on wall-mounted supply elbow

Hand shower:

- A- 4" diameter mechanism
- B- 3-spray mechanism: rain, massage and mix of the two
- C- Easy-to-clean silicone nozzles
- D- 2 gpm - 80 psi
- E- DOU-2566-03-xx

Wall-mounted supply elbow:

- F- 1/2" F connection
- G- Brass elbow
- H- RAC-9001-19-xx

Hose:

- I- Conical nut 1/2" female
- J- 59" (150 cm) double interlock flexible hose, rotating nut with 2 non-return valves
- K- PVC hose in KK finish or brass for other finishes

Ecological options

Codes	Reduced flow rates
DSP-2566-19-xx-150	1.5 gpm (5.7 l/min) - 80 psi
DSP-2566-19-xx-175	1.75 gpm (6.6 l/min) - 80 psi

CEC

Actual products may differ from pictures. Actual products measures may differ from the measures shown. All USD prices are subject to change without notice. Effective as of August 2023.

DSP-2574-19-xx

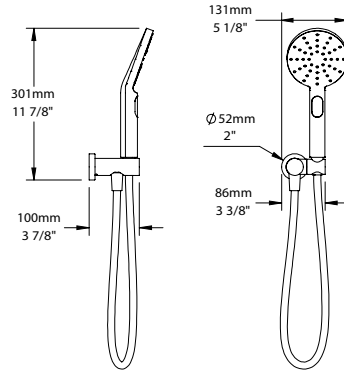

CC	KK	LL	BB	NN/YY	VV/TT	GG
466	606	699	699	606	745	1025

3-spray anti-limestone hand shower on wall-mounted supply elbow

Hand shower:

- A- 4-3/4" diameter mechanism
- B- 3-spray mechanism: rain, mist and mix of the two
- C- Push-button mechanism
- D- Easy-to-clean silicone nozzles
- E- 2 gpm - 80 psi
- F- DOU-2574-03-xx

Wall-mounted supply elbow:

- G- 1/2" F connection
- H- Brass elbow
- I- RAC-9001-19-xx

Hose:

- J- Conical nut 1/2" female
- K- 59" (150 cm) double interlock flexible hose, rotating nut with 2 non-return valves
- L- PVC hose in KK finish or brass for other finishes

Ecological options

Codes	Reduced flow rates
DSP-2574-19-xx-150	1.5 gpm (5.7 l/min) - 80 psi
DSP-2574-19-xx-175	1.75 gpm (6.6 l/min) - 80 psi



DSP-2584-19-xx

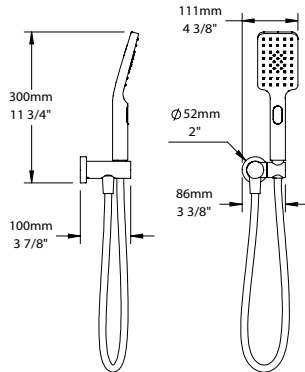

CC	KK	LL	BB	NN/YY	VV/TT	GG
476	619	714	714	619	761	1047

3-spray anti-limestone hand shower on wall-mounted supply elbow

Hand shower:

- A- 3-spray mechanism: rain, mist and mix of the two
- B- Push-button mechanism
- C- Easy-to-clean silicone nozzles
- D- 2 gpm - 80 psi
- E- DOU-2584-03-xx

Wall-mounted supply elbow:

- F- 1/2" F connection
- G- Brass elbow
- H- RAC-9001-19-xx

Hose:

- I- Conical nut 1/2" female
- J- 59" (150 cm) double interlock flexible hose, rotating nut with 2 non-return valves
- K- PVC hose in KK finish or brass for other finishes

Ecological options

Codes	Reduced flow rates
DSP-2584-19-xx-150	1.5 gpm (5.7 l/min) - 80 psi
DSP-2584-19-xx-175	1.75 gpm (6.6 l/min) - 80 psi



DSP-2584-20-xx

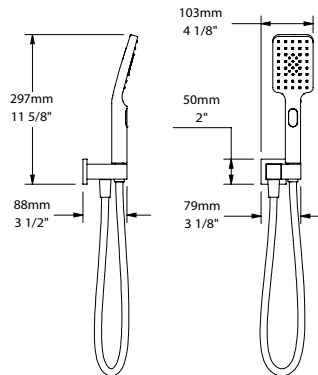

CC	KK	LL	BB	NN/YY	VV/TT	GG
524	682	786	786	682	838	1152

3-spray anti-limestone hand shower on wall-mounted supply elbow

Hand shower:

- A- 3-spray mechanism: rain, mist and mix of the two
- B- Push-button mechanism
- C- Easy-to-clean silicone nozzles
- D- 2 gpm - 80 psi
- E- DOU-2584-03-xx

Wall-mounted supply elbow:

- F- 1/2" F connection
- G- Brass elbow
- H- RAC-9001-20-xx

Hose:

- I- Conical nut 1/2" female
- J- 59" (150 cm) double interlock flexible hose, rotating nut with 2 non-return valves
- K- PVC hose in KK finish or brass for other finishes

Ecological options

Codes	Reduced flow rates
DSP-2584-20-xx-150	1.5 gpm (5.7 l/min) - 80 psi
DSP-2584-20-xx-175	1.75 gpm (6.6 l/min) - 80 psi



Finishes:

CC = chrome, KK = matte black, LL = satin brass, BB = white, NN = brushed nickel, YY = polished nickel, TT = venetian bronze, VV = satin copper, GG = gold

COMPONENTS

HAND SHOWER ON WALL-MOUNTED SUPPLY ELBOW

DSP-2604-19-xx

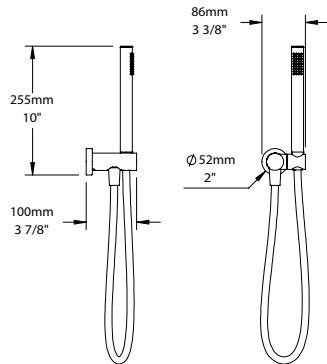

CC	KK	LL	BB	NN/YY	VV/TT	GG
492	639	738	738	639	787	1083

1-spray anti-limestone hand shower on wall-mounted supply elbow

Hand shower:

- A- Single spray pattern
- B- Easy-to-clean silicone nozzles
- C- 2 gpm - 80 psi
- D- Brass construction
- E- DOU-2604-01-xx

Wall-mounted supply elbow:

- F- 1/2" F connection
- G- Brass elbow
- H- RAC-9001-19-xx

Hose:

- I- Conical nut 1/2" female
- J- 59" (150 cm) double interlock flexible hose, rotating nut with 2 non-return valves
- K- PVC hose in KK finish or brass for other finishes

Ecological options

Codes	Reduced flow rates
DSP-2604-19-xx-150	1.5 gpm (5.7 l/min) - 80 psi
DSP-2604-19-xx-175	1.75 gpm (6.6 l/min) - 80 psi

CEC

DSP-2604-21-xx

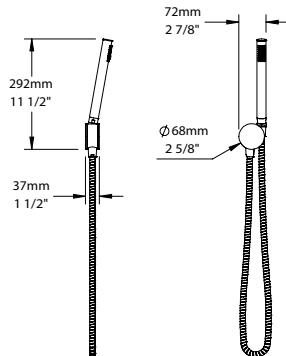

Cx	Kx	Lx	Bx	Nx/Yx	Vx/Tx	Gx
641	833	994	994	833	1026	1443

1-spray anti-limestone hand shower on wall-mounted supply elbow

Hand shower:

- A- Single spray pattern
- B- Easy-to-clean silicone nozzles
- C- 2 gpm - 80 psi
- D- Brass construction
- E- DOU-2604-01-xx

Wall-mounted supply elbow:

- F- 1/2" F connection
- G- Brass elbow
- H- RAC-9001-21-xx

Hose:

- I- Conical nut 1/2" female
- J- 59" (150 cm) double interlock flexible hose, rotating nut with 2 non-return valves
- K- PVC hose in KK finish or brass for other finishes

Ecological options

Codes	Reduced flow rates
DSP-2604-21-xx-150	1.5 gpm (5.7 l/min) - 80 psi
DSP-2604-21-xx-175	1.75 gpm (6.6 l/min) - 80 psi

CEC

DSP-2635-19-xx

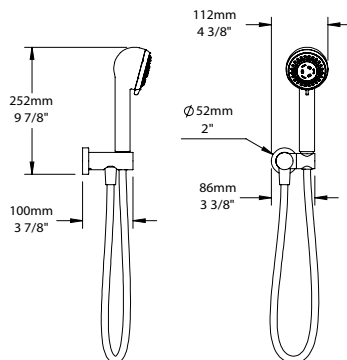

CC	KK	LL	BB	NN/YY	VV/TT	GG
534	694	801	801	694	854	1175

2-spray anti-limestone hand shower on wall-mounted supply elbow

Hand shower:

- A- 3-1/4" diameter mechanism
- B- 2-spray mechanism: rain and massage
- C- Easy-to-clean silicone nozzles
- D- 2 gpm - 80 psi
- E- DOU-2635-02-xx

Wall-mounted supply elbow:

- F- 1/2" F connection
- G- Brass elbow
- H- RAC-9001-19-xx

Hose:

- I- Conical nut 1/2" female
- J- 59" (150 cm) double interlock flexible hose, rotating nut with 2 non-return valves
- K- PVC hose in KK finish or brass for other finishes

Ecological options

Codes	Reduced flow rates
DSP-2635-19-xx-150	1.5 gpm (5.7 l/min) - 80 psi
DSP-2635-19-xx-175	1.75 gpm (6.6 l/min) - 80 psi

CEC

Actual products may differ from pictures. Actual products measures may differ from the measures shown. All USD prices are subject to change without notice. Effective as of August 2023.

DGL-1670-03-xx

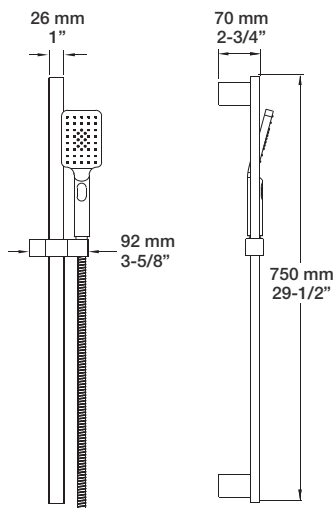

CC	KK	LL	BB	NN/YY	VV/TT	GG
694	902	1041	1041	902	1110	1527

3-spray sliding shower bar

- A- 3-spray push-button anti-limestone hand shower
- B- 3-spray mechanism: rain, mist and mix of the two
- C- Max: 2 gpm - 80 psi
- D- Easy-to-clean silicone nozzles
- E- DOU-2584-03-xx
- F- 59" (150 cm) double interlock flexible hose, rotating nut with 2 non-return valves
- G- PVC hose in KK finish or brass for other finishes

Ecological options

Codes	Reduced flow rates
DGL-1670-03-xx-150	1.5 gpm (5.7 l/min) - 80 psi
DGL-1670-03-xx-175	1.75 gpm (6.6 l/min) - 80 psi

DGL-2070-51-xx

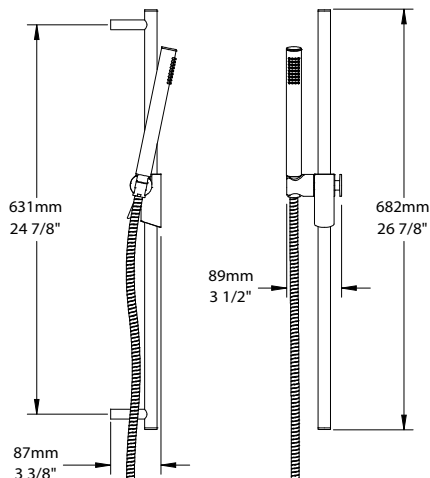

CC	KK	LL	BB	NN/YY	VV/TT	GG
679	883	1019	1019	883	1086	1494

1-spray sliding shower bar

- A- 1-spray anti-limestone hand shower
- B- Single spray pattern
- C- Max: 2 gpm - 80 psi
- D- Easy-to-clean silicone nozzles
- E- DOU-2604-01-xx
- F- Easy to move metal slider
- G- Built-in hook on the slider
- H- 59" (150 cm) double interlock flexible hose, rotating nut with 2 non-return valves
- I- PVC hose in KK finish or brass for other finishes
- J- Ø 2" decorative flange included

Ecological options

Codes	Reduced flow rates
DGL-2070-51-xx-150	1.5 gpm (5.7 l/min) - 80 psi
DGL-2070-51-xx-175	1.75 gpm (6.6 l/min) - 80 psi

DGL-2070-53-xx

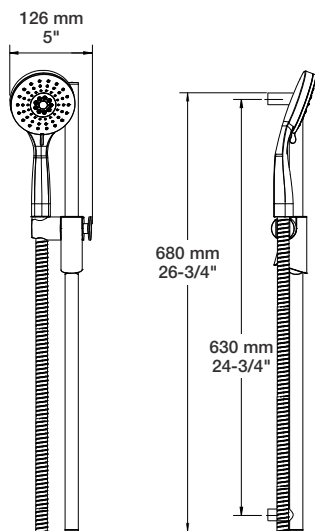

CC	KK	LL	BB	NN/YY	VV/TT	GG
548	712	822	822	712	877	1206

3-spray sliding shower bar

- A- 3-spray anti-limestone hand shower
- B- 4" diameter mechanism
- C- 3-spray mechanism: rain, massage and mix of the two
- D- Max: 2 gpm - 80 psi
- E- Easy-to-clean nozzles for all functions
- F- DOU-2566-03-xx
- G- Easy to move metal slider
- H- Built-in hook on the slider
- I- 59" (150 cm) double interlock flexible hose, rotating nut with 2 non-return valves
- J- PVC hose in KK finish or brass for other finishes
- K- Ø 2" decorative flange included

Ecological options

Codes	Reduced flow rates
DGL-2070-53-xx-150	1.5 gpm (5.7 l/min) - 80 psi
DGL-2070-53-xx-175	1.75 gpm (6.6 l/min) - 80 psi

Finishes:

CC = chrome, KK = matte black, LL = satin brass, BB = white, NN = brushed nickel, YY = polished nickel, TT = venetian bronze, VV = satin copper, GG = gold

COMPONENTS

SLIDING SHOWER BARS

DGL-2070-57-xx

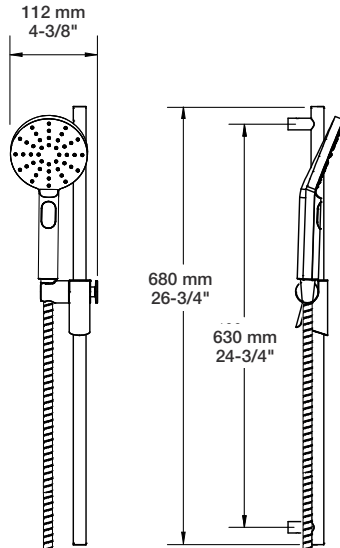

CC	KK	LL	BB	NN/YY	VV/TT	GG
594	772	891	891	772	950	1307

3-spray sliding shower bar

- A- 3-spray push-button anti-limestone hand shower
- B- 4-3/4" diameter mechanism
- C- 3-spray mechanism: rain, mist and mix of the two
- D- Max: 2 gpm - 80 psi
- E- Easy-to-clean nozzles for all functions
- F- DOU-2574-03-xx
- G- Easy to move metal slider
- H- Built-in hook on the slider
- I- 59" (150 cm) double interlock flexible hose, rotating nut with 2 non-return valves
- J- PVC hose in KK finish or brass for other finishes
- K- Ø 2" decorative flange included

Ecological options

Codes	Reduced flow rates
DGL-2070-57-xx-150	1.5 gpm (5.7 l/min) - 80 psi
DGL-2070-57-xx-175	1.75 gpm (6.6 l/min) - 80 psi



DGL-2070-62-xx

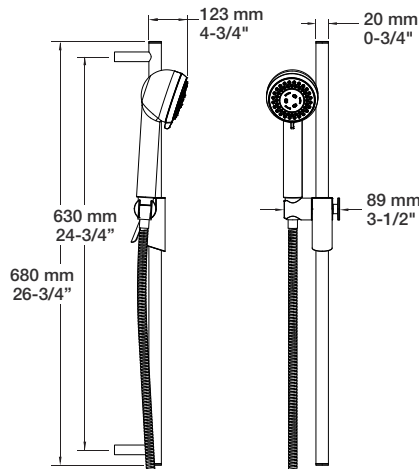

CC	CI	CK	KK	KI	LL	BB	NN/YY	VV/TT	GG
798	958	958	1037	1080	1197	1197	1037	1277	1756

2-spray sliding shower bar

- A- 2-spray push-button anti-limestone hand shower
- B- 3-1/4" diameter mechanism
- C- 2-spray mechanism: rain, mist
- D- Max: 2 gpm - 80 psi
- E- Easy-to-clean nozzles
- F- DOU-2635-02-xx
- G- Easy to move metal slider
- H- Built-in hook on the slider
- I- 59" (150 cm) double interlock flexible hose, rotating nut with 2 non-return valves
- J- PVC hose in KK finish or brass for other finishes
- K- Ø 2" decorative flange included

Ecological options

Codes	Reduced flow rates
DGL-2070-62-xx-150	1.5 gpm (5.7 l/min) - 80 psi
DGL-2070-62-xx-175	1.75 gpm (6.6 l/min) - 80 psi



DGL-2160-04-xx

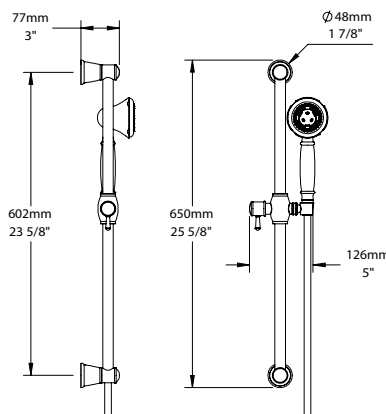

CC	KK	LL	BB	NN/YY	VV/TT	GG
798	1037	1197	1197	1037	1277	1756

4-spray sliding shower bar

- A- 4-spray anti-limestone hand shower
- B- 2-1/2" diameter mechanism
- C- 4-spray mechanism: rain, hard rain, mix of the two and massage
- D- Max: 2 gpm - 80 psi
- E- Easy-to-clean nozzles for all functions
- F- DOU-2535-04-xx
- G- 59" (150 cm) double interlock flexible hose, rotating nut with 2 non-return valves
- H- PVC hose in KK finish or brass for other finishes

Ecological options

Codes	Reduced flow rates
DGL-2160-04-xx-150	1.5 gpm (5.7 l/min) - 80 psi
DGL-2160-04-xx-175	1.75 gpm (6.6 l/min) - 80 psi



Actual products may differ from pictures. Actual products measures may differ from the measures shown. All USD prices are subject to change without notice. Effective as of August 2023.

DGL-2170-63-xx

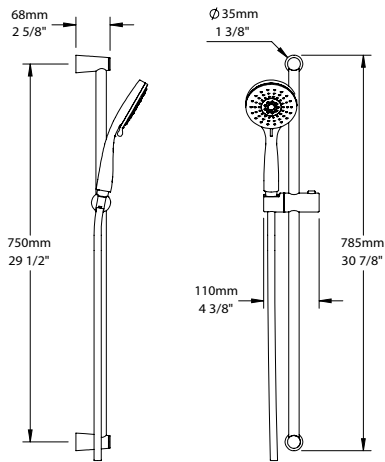

CC	KK	LL	BB	NN/YY	VV/TT	GG
449	584	674	674	584	718	988

3-spray sliding shower bar

- A- 3-spray anti-limestone hand shower
- B- 4" diameter mechanism
- C- 3-spray mechanism: rain, massage and mix of the two
- D- Max: 2 gpm - 80 psi
- E- Easy-to-clean nozzles for all functions
- F- DOU-2566-03-xx
- G- 59" (150 cm) double interlock flexible hose, rotating nut with 2 non-return valves
- H- PVC hose in KK finish or brass for other finishes

Ecological options

Codes	Reduced flow rates
DGL-2170-63-xx-150	1.5 gpm (5.7 l/min) - 80 psi
DGL-2170-63-xx-175	1.75 gpm (6.6 l/min) - 80 psi

DGL-2175-52-xx

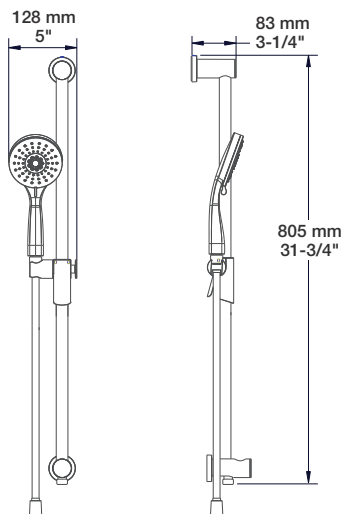

CC	KK	LL	BB	NN/YY	VV/TT	GG
543	706	815	815	706	869	1195

3-spray sliding shower bar with built-in supply elbow

- A- 3-spray anti-limestone hand shower
- B- 4" diameter mechanism
- C- 3-spray mechanism: rain, massage and mix of the two
- D- Max: 2 gpm - 80 psi
- E- Easy-to-clean nozzles for all functions
- F- DOU-2566-03-xx
- G- Easy to move metal slider
- H- Built-in hook on the slider
- I- Built-in wall supply elbow (1/2" F connection)
- J- 59" (150 cm) double interlock flexible hose, rotating nut with 2 non-return valves
- K- PVC hose in KK finish or brass for other finishes

Ecological options

Codes	Reduced flow rates
DGL-2175-52-xx-150	1.5 gpm (5.7 l/min) - 80 psi
DGL-2175-52-xx-175	1.75 gpm (6.6 l/min) - 80 psi

THE ESSENTIALS

DGL-2175-53-xx

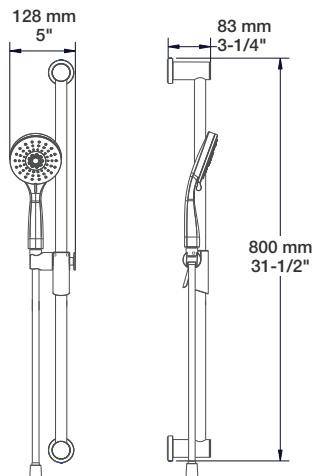

CC	KK	LL	BB	NN/YY	VV/TT	GG
468	608	702	702	608	749	1030

3-spray sliding shower bar

- A- 3-spray anti-limestone hand shower
- B- 4" diameter mechanism
- C- 3-spray mechanism: rain, massage and mix of the two
- D- Max: 2 gpm - 80 psi
- E- Easy-to-clean nozzles for all functions
- F- DOU-2566-03-xx
- G- Easy to move metal slider
- H- Built-in hook on the slider
- I- 59" (150 cm) double interlock flexible hose, rotating nut with 2 non-return valves
- J- PVC hose in KK finish or brass for other finishes

Ecological options

Codes	Reduced flow rates
DGL-2175-53-xx-150	1.5 gpm (5.7 l/min) - 80 psi
DGL-2175-53-xx-175	1.75 gpm (6.6 l/min) - 80 psi

Finishes:

CC = chrome, KK = matte black, LL = satin brass, BB = white, CI = chrome mist, CK = chrome matte black, KI = matte black mist, NN = brushed nickel, YY = polished nickel, TT = venetian bronze, VV = satin copper, GG = gold

COMPONENTS

SLIDING SHOWER BARS

DGL-2580-53-xx

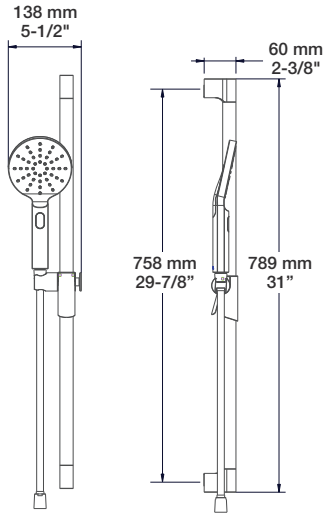

THE ESSENTIALS

CC	KK	LL	BB	NN/YY	VV/TT	GG
594	772	891	891	772	950	1307

3-spray sliding shower bar

- A- 3-spray push-button anti-limestone hand shower
- B- 4-3/4" diameter mechanism
- C- 3-spray mechanism: rain, mist and mix of the two
- D- Max: 2 gpm - 80 psi
- E- Easy-to-clean silicone nozzles
- F- DOU-2574-03-xx
- G- Easy to move metal slider
- H- Built-in hook on the slider
- I- 59" (150 cm) double interlock flexible hose, rotating nut with 2 non-return valves
- J- PVC hose in KK finish or brass for other finishes

Ecological options

Codes	Reduced flow rates
DGL-2580-53-xx-150	1.5 gpm (5.7 l/min) - 80 psi
DGL-2580-53-xx-175	1.75 gpm (6.6 l/min) - 80 psi

CEC

DGL-2584-53-xx

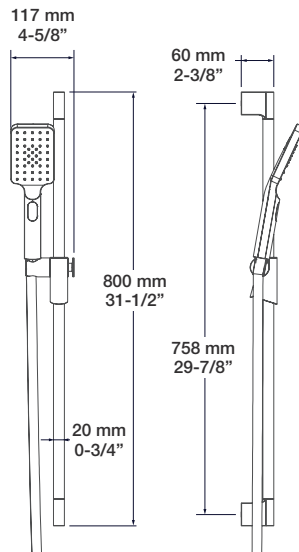

THE ESSENTIALS

CC	KK	LL	BB	NN/YY	VV/TT	KM	GG
604	785	906	906	785	966	966	1329

3-spray sliding shower bar

- A- 3-spray push-button anti-limestone hand shower
- B- 3-spray mechanism: rain, mist and mix of the two
- C- Max: 2 gpm - 80 psi
- D- Easy-to-clean silicone nozzles
- E- DOU-2584-03-xx
- F- Easy to move metal slider
- G- Built-in hook on the slider
- H- 59" (150 cm) double interlock flexible hose, rotating nut with 2 non-return valves
- I- PVC hose in KK finish or brass for other finishes

Ecological options

Codes	Reduced flow rates
DGL-2584-53-xx-150	1.5 gpm (5.7 l/min) - 80 psi
DGL-2584-53-xx-175	1.75 gpm (6.6 l/min) - 80 psi

CEC

DGL-3070-53-xx

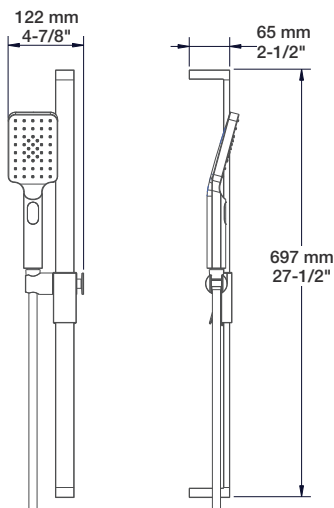

CC	KK	LL	BB	NN/YY	VV/TT	GG
629	818	944	944	818	1006	1384

3-spray sliding shower bar

- A- 3-spray push-button anti-limestone hand shower
- B- 3-spray mechanism: rain, mist and mix of the two
- C- Max: 2 gpm - 80 psi
- D- Easy-to-clean silicone nozzles
- E- DOU-2584-03-xx
- F- Easy to move metal slider
- G- Built-in hook on the slider
- H- 59" (150 cm) double interlock flexible hose, rotating nut with 2 non-return valves
- I- PVC hose in KK finish or brass for other finishes

Ecological options

Codes	Reduced flow rates
DGL-3070-53-xx-150	1.5 gpm (5.7 l/min) - 80 psi
DGL-3070-53-xx-175	1.75 gpm (6.6 l/min) - 80 psi

CEC

Actual products may differ from pictures. Actual products measures may differ from the measures shown. All USD prices are subject to change without notice. Effective as of August 2023.

DGL-3080-73-xx

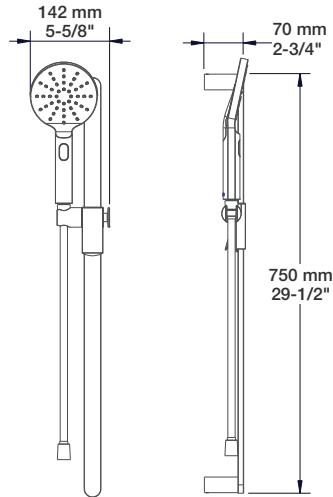

CC	KK	LL	BB	NN/YY	VV/TT	GG
749	974	1124	1124	974	1198	1648

3-spray sliding shower bar

- A- 3-spray push-button anti-limestone hand shower
- B- 4-3/4" diameter mechanism
- C- 3-spray mechanism: rain, mist and mix of the two
- D- Max: 2 gpm - 80 psi
- E- Easy-to-clean silicone nozzles
- F- DOU-2574-03-xx
- G- Easy to move metal slider
- H- Built-in hook on the slider
- I- 59" (150 cm) flexible hose, rotating nut with 2 non-return valves
- J- PVC hose in CC and KK finishes or brass for other finishes

Ecological options

Codes	Reduced flow rates
DGL-3080-73-xx-150	1.5 gpm (5.7 l/min) - 80 psi
DGL-3080-73-xx-175	1.75 gpm (6.6 l/min) - 80 psi

DGL-3080-83-xx

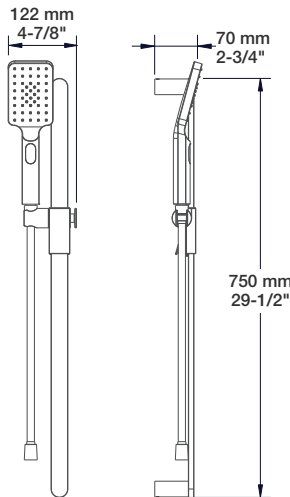

CC	KK	LL	BB	NN/YY	VV/TT	GG
759	987	1139	1139	987	1214	1670

3-spray sliding shower bar

- A- 3-spray push-button anti-limestone hand shower
- B- 3-spray mechanism: rain, mist and mix of the two
- C- Max: 2 gpm - 80 psi
- D- Easy-to-clean silicone nozzles
- E- DOU-2584-03-xx
- F- Easy to move metal slider
- G- Built-in hook on the slider
- H- 59" (150 cm) flexible hose, rotating nut with 2 non-return valves
- I- PVC hose in CC and KK finishes or brass for other finishes

Ecological options

Codes	Reduced flow rates
DGL-3080-83-xx-150	1.5 gpm (5.7 l/min) - 80 psi
DGL-3080-83-xx-175	1.75 gpm (6.6 l/min) - 80 psi

DGL-3097-73-xx

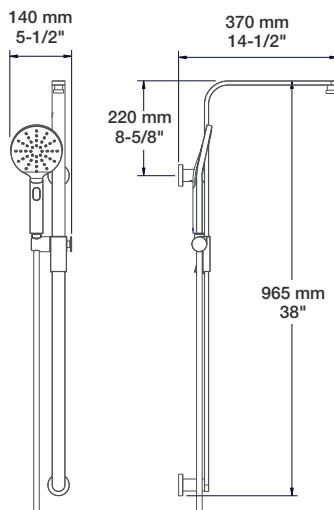

CC	KK	LL	BB	NN/YY	VV/TT	GG
999	1299	1499	1499	1299	1598	2198

Shower column, shower head not included

- A- 3-spray push-button anti-limestone hand shower
- B- 4-3/4" diameter mechanism
- C- 3-spray mechanism: rain, mist and mix of the two
- D- Max: 2 gpm - 80 psi
- E- Easy-to-clean silicone nozzles
- F- DOU-2574-03-xx
- G- Easy to move metal slider
- H- Built-in hook on the slider
- I- 1/2" F NPT connection to supply the shower head
- J- Separate volume control valves or diverter required to operate the shower head and hand shower
- K- Please order a wall-mount supply elbow for the hand shower hose
- L- 59" (150 cm) flexible hose, rotating nut with 2 non-return valves
- M- PVC hose in KK finish or brass for other finishes

Ecological options

Codes	Reduced flow rates
DGL-3097-73-xx-150	1.5 gpm (5.7 l/min) - 80 psi
DGL-3097-73-xx-175	1.75 gpm (6.6 l/min) - 80 psi

Finishes:

CC = chrome, KK = matte black, LL = satin brass, BB = white, NN = brushed nickel, YY = polished nickel, TT = venetian bronze, VV = satin copper, KM = black titanium, GG = gold

COMPONENTS

SLIDING SHOWER BARS

DGL-4880-03-xx

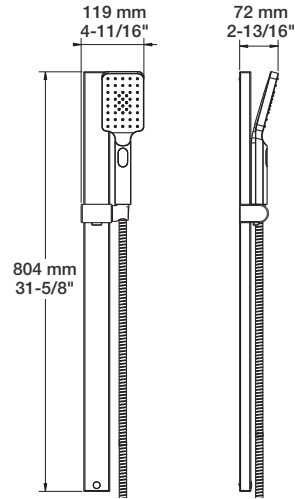
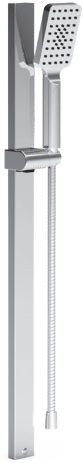

CC	KK	LL	BB	NN/YY	VV/TT	GG
849	1104	1274	1274	1104	1358	1868

3-spray sliding shower bar

- A- 3-spray push-button anti-limestone hand shower
- B- 3-spray mechanism: rain, mist and mix of the two
- C- Max: 2 gpm - 80 psi
- D- Easy-to-clean silicone nozzles
- E- DOU-2584-03-xx
- F- 59" (150 cm) double interlock flexible hose, rotating nut with 2 non-return valves
- G- PVC hose in KK finish or brass for other finishes

Ecological options

Codes	Reduced flow rates
DGL-4880-03-xx-150	1.5 gpm (5.7 l/min) - 80 psi
DGL-4880-03-xx-175	1.75 gpm (6.6 l/min) - 80 psi

CEC

Actual products may differ from pictures. Actual products measures may differ from the measures shown. All USD prices are subject to change without notice. Effective as of August 2023.

BGL-1670-00-xx

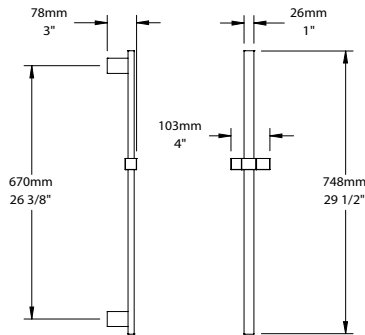

CC	KK	LL	BB	NN/YY	VV/TT	GG
625	812	937	937	812	999	1374

Shower bar with slider

BGL-2070-50-xx

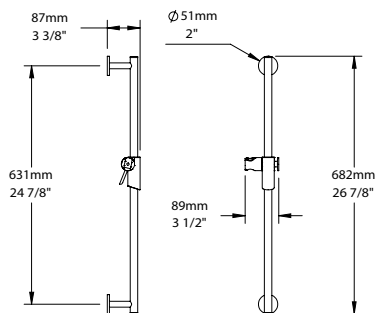

CC	KK	LL	BB	NN/YY	VV/TT	GG
535	695	802	802	695	855	1176

Shower bar with slider

- A- Easy to move metal slider
- B- Built-in hook on the slider
- C- Ø 2" decorative flange included

BGL-2160-00-xx

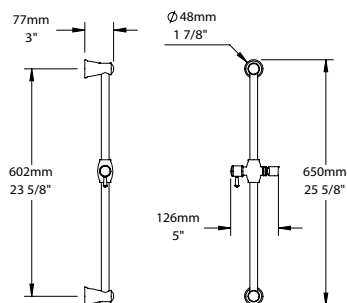

CC	KK	LL	BB	NN/YY	VV/TT	GG
718	933	1077	1077	933	1149	1580

Shower bar with slider

BGL-2175-50-xx

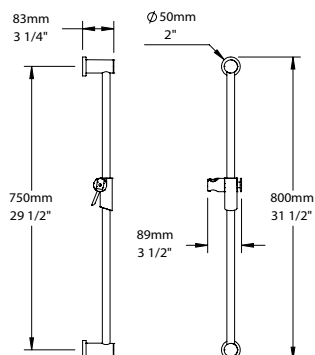

CC	KK	LL	BB	NN/YY	VV/TT	GG
421	547	632	632	547	674	927

Shower bar with slider

- A- Easy to move metal slider
- B- Built-in hook on the slider

Finishes:

CC = chrome, KK = matte black, LL = satin brass, BB = white, NN = brushed nickel, YY = polished nickel, TT = venetian bronze, VV = satin copper, GG = gold

COMPONENTS

SHOWER BARS WITH SLIDER

BGL-2175-70-xx

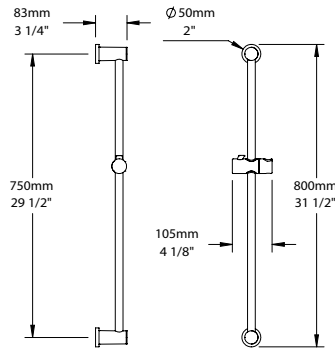

CC	KK	LL	BB	NN/YY	VV/TT	GG
404	526	607	607	526	646	889

Shower bar with slider

BGL-2175-90-xx

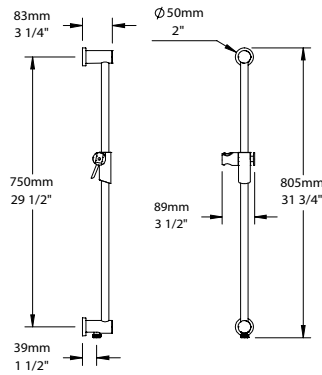

CC	KK	LL	BB	NN/YY	VV/TT	GG
489	635	734	734	635	782	1076

Shower bar with slider

- A- Easy to move metal slider
- B- Built-in hook on the slider
- C- Built-in wall supply elbow (1/2" F connection)

BGL-2580-50-xx

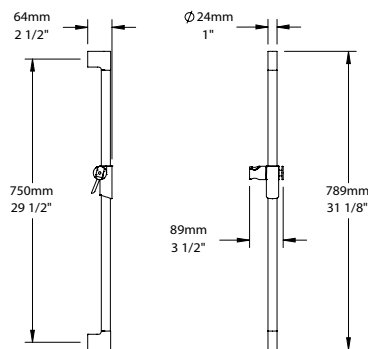

CC	KK	LL	BB	NN/YY	VV/TT	GG
535	695	802	802	695	855	1176

Shower bar with slider

- A- Easy to move metal slider
- B- Built-in hook on the slider

BGL-3070-50-xx

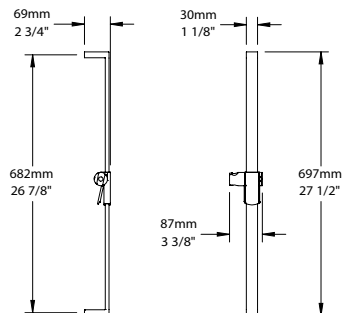

CC	KK	LL	BB	NN/YY	VV/TT	GG
566	736	850	850	736	905	1246

Shower bar with slider

- A- Easy to move metal slider
- B- Built-in hook on the slider

Actual products may differ from pictures. Actual products measures may differ from the measures shown. All USD prices are subject to change without notice. Effective as of August 2023.

BGL-3080-50-xx

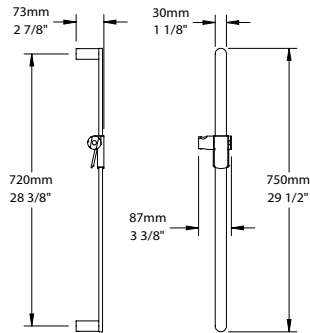

CC	KK	LL	BB	NN/YY	VV/TT	GG
674	877	1012	1012	877	1078	1483

Shower bar with slider

- A- Easy to move metal slider
- B- Built-in hook on the slider

BGL-3097-50-xx

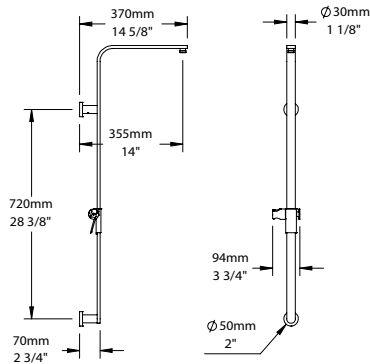

CC	KK	LL	BB	NN/YY	VV/TT	GG
899	1169	1349	1349	1169	1438	1978

Shower column with slider

- A- Easy to move metal slider
- B- Built-in hook on the slider
- C- 1/2" F NPT connection to supply the shower head

BGL-4880-00-xx

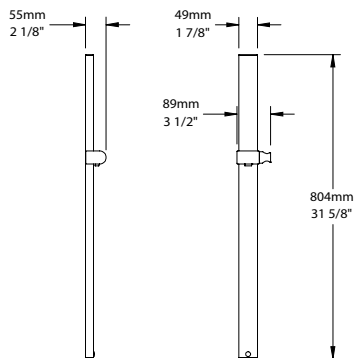

CC	KK	LL	BB	NN/YY	VV/TT	GG
764	994	1147	1147	994	1222	1681

Shower bar with slider

Finishes:

CC = chrome, KK = matte black, LL = satin brass, BB = white, NN = brushed nickel, YY = polished nickel, TT = venetian bronze, VV = satin copper, GG = gold

COMPONENTS

HAND SHOWERS

DOU-1219-01-xx



CC	KK	LL	BB	NN/YY	VV/TT	GG
129	168	194	194	168	206	284

1-spray hand shower

- A- Single spray pattern
- B- 2 gpm - 80 psi
- C- Brass construction

Ecological options

Codes	Reduced flow rates
DOU-1219-01-xx-150	1.5 gpm (5.7 l/min) - 80 psi
DOU-1219-01-xx-175	1.75 gpm (6.6 l/min) - 80 psi

CEC

DOU-1455-02-xx



CC	KK	LL	BB	NN/YY	VV/TT	GG
234	304	351	351	304	374	515

1-spray anti-limestone brass hand shower with elbow and conical nut included

- A- Single spray pattern
- B- Easy-to-clean silicone nozzles
- C- 2 gpm - 80 psi
- D- Conical nut included
- E- 1/2 M or 15x1 F connection

Ecological options

Codes	Reduced flow rates
DOU-1455-02-xx-150	1.5 gpm (5.7 l/min) - 80 psi
DOU-1455-02-xx-175	1.75 gpm (6.6 l/min) - 80 psi

CEC

DOU-2515-04-xx



CC	KK	LL	BB	NN/YY	VV/TT	GG
399	519	599	599	519	639	878

4-spray anti-limestone hand shower

- A- 2-1/2" diameter mechanism
- B- 4-spray mechanism: rain, hard rain, mix of the two and massage
- C- Easy-to-clean nozzles for all functions
- D- 2 gpm - 80 psi

Ecological options

Codes	Reduced flow rates
DOU-2515-04-xx-150	1.5 gpm (5.7 l/min) - 80 psi
DOU-2515-04-xx-175	1.75 gpm (6.6 l/min) - 80 psi

CEC

DOU-2535-04-xx



CC	KK	LL	BB	NN/YY	VV/TT	GG
396	515	594	594	515	634	871

4-spray anti-limestone hand shower

- A- 2-1/2" diameter mechanism
- B- 4-spray mechanism: rain, hard rain, mix of the two and massage
- C- Easy-to-clean nozzles for all functions
- D- 2 gpm - 80 psi

Ecological options

Codes	Reduced flow rates
DOU-2535-04-xx-150	1.5 gpm (5.7 l/min) - 80 psi
DOU-2535-04-xx-175	1.75 gpm (6.6 l/min) - 80 psi

CEC

Actual products may differ from pictures. Actual products measures may differ from the measures shown. All USD prices are subject to change without notice. Effective as of August 2023.

DOU-2550-01-xx



CC	KK	LL	BB	NN/YY	VV/TT	GG
198	257	297	297	257	317	436

1-spray anti-limestone hand shower

- A- Single spray pattern
- B- Easy-to-clean silicone nozzles
- C- 2 gpm - 80 psi

Ecological options

Codes	Reduced flow rates
DOU-2550-01-xx-150	1.5 gpm (5.7 l/min) - 80 psi
DOU-2550-01-xx-175	1.75 gpm (6.6 l/min) - 80 psi



DOU-2551-03-xx



CC	KK	LL	BB	NN/YY	VV/TT	GG
124	161	186	186	161	198	273

3-spray hand shower

- A- 4" diameter mechanism
- B- 3-spray mechanism: rain, massage and mix of the two
- C- Easy-to-clean nozzles for all functions
- D- 2 gpm - 80 psi

Ecological options

Codes	Reduced flow rates
DOU-2551-03-xx-150	1.5 gpm (5.7 l/min) - 80 psi
DOU-2551-03-xx-175	1.75 gpm (6.6 l/min) - 80 psi



DOU-2553-04-xx



CC	KK	LL	BB	NN/YY	VV/TT	GG
285	371	428	428	371	456	627

4-spray anti-limestone hand shower

- A- 2-1/2" diameter mechanism
- B- 4-spray mechanism: rain, hard rain, mix of the two and massage
- C- Easy-to-clean nozzles for all functions
- D- 2 gpm - 80 psi

Ecological options

Codes	Reduced flow rates
DOU-2553-04-xx-150	1.5 gpm (5.7 l/min) - 80 psi
DOU-2553-04-xx-175	1.75 gpm (6.6 l/min) - 80 psi



DOU-2555-01-xx



CC	KK	LL	BB	NN/YY	VV/TT	GG
94	122	141	141	122	150	207

1-spray anti-limestone hand shower

- A- Single spray pattern
- B- Easy-to-clean silicone nozzles
- C- 2 gpm - 80 psi

Ecological options

Codes	Reduced flow rates
DOU-2555-01-xx-150	1.5 gpm (5.7 l/min) - 80 psi
DOU-2555-01-xx-175	1.75 gpm (6.6 l/min) - 80 psi



Finishes:

CC = chrome, KK = matte black, LL = satin brass, BB = white, NN = brushed nickel, YY = polished nickel, TT = venetian bronze, VV = satin copper, GG = gold

COMPONENTS

HAND SHOWERS

DOU-2561-01-xx



CC	KK
75	98

1-spray anti-limestone hand shower

- A- Single spray pattern
- B- Easy-to-clean silicone nozzles
- C- 2 gpm - 80 psi

Ecological options

Codes	Reduced flow rates
DOU-2561-01-xx-150	1.5 gpm (5.7 l/min) - 80 psi
DOU-2561-01-xx-175	1.75 gpm (6.6 l/min) - 80 psi

CEC

DOU-2566-03-xx



CC	KK	LL	BB	NN/YY	VV/TT	GG
129	168	194	194	168	206	284

3-spray anti-limestone hand shower

- A- 4" diameter mechanism
- B- 3-spray mechanism: rain, massage and mix of the two
- C- Easy-to-clean silicone nozzles
- D- 2 gpm - 80 psi

Ecological options

Codes	Reduced flow rates
DOU-2566-03-xx-150	1.5 gpm (5.7 l/min) - 80 psi
DOU-2566-03-xx-175	1.75 gpm (6.6 l/min) - 80 psi

CEC

DOU-2574-03-xx



CC	KK	LL	BB	NN/YY	VV/TT	GG
172	224	258	258	224	275	378

3-spray anti-limestone hand shower

- A- 4-3/4" diameter mechanism
- B- 3-spray mechanism: rain, mist and mix of the two
- C- Push-button mechanism
- D- Easy-to-clean silicone nozzles
- E- 2 gpm - 80 psi

Ecological options

Codes	Reduced flow rates
DOU-2574-03-xx-150	1.5 gpm (5.7 l/min) - 80 psi
DOU-2574-03-xx-175	1.75 gpm (6.6 l/min) - 80 psi

CEC

DOU-2584-03-xx



CC	KK	LL	BB	NN/YY	VV/TT	KM	GG
182	237	273	273	237	291	291	400

3-spray anti-limestone hand shower

- A- 3-spray mechanism: rain, mist and mix of the two
- B- Push-button mechanism
- C- Easy-to-clean silicone nozzles
- D- 2 gpm - 80 psi

Ecological options

Codes	Reduced flow rates
DOU-2584-03-xx-150	1.5 gpm (5.7 l/min) - 80 psi
DOU-2584-03-xx-175	1.75 gpm (6.6 l/min) - 80 psi

CEC

Actual products may differ from pictures. Actual products measures may differ from the measures shown. All USD prices are subject to change without notice. Effective as of August 2023.

DOU-2604-01-xx



CC	KK	LL	BB	NN/YY	VV/TT	KM	GG
198	257	297	297	257	317	317	436

1-spray anti-limestone hand shower

- A- Single spray pattern
- B- Easy-to-clean silicone nozzles
- C- 2 gpm - 80 psi
- D- Brass construction

Ecological options

Codes	Reduced flow rates
DOU-2604-01-xx-150	1.5 gpm (5.7 l/min) - 80 psi
DOU-2604-01-xx-175	1.75 gpm (6.6 l/min) - 80 psi

CEC

DOU-2635-02-xx



CC	KK	LL	BB	II	NN/YY	VV/TT	GG
240	312	360	360	316	312	384	528

2-spray anti-limestone hand shower

- A- 3-1/4" diameter mechanism
- B- 2-spray mechanism: rain, massage
- C- Easy-to-clean silicone nozzles
- D- 2 gpm - 80 psi

Ecological options

Codes	Reduced flow rates
DOU-2635-02-xx-150	1.5 gpm (5.7 l/min) - 80 psi
DOU-2635-02-xx-175	1.75 gpm (6.6 l/min) - 80 psi

CEC

DOU-2652-01-xx

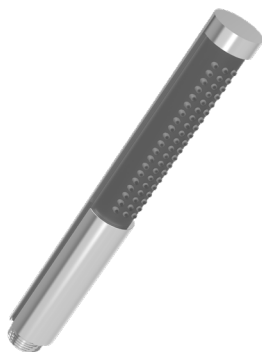

CF
209

1-spray anti-limestone hand shower

- A- Single spray pattern
- B- Easy-to-clean silicone nozzles
- C- 2 gpm - 80 psi

Ecological options

Codes	Reduced flow rates
DOU-2652-01-xx-150	1.5 gpm (5.7 l/min) - 80 psi
DOU-2652-01-xx-175	1.75 gpm (6.6 l/min) - 80 psi

CEC

Finishes:

CC = chrome, CF = smokey chrome, KK = matte black, LL = satin brass, BB = white, NN = brushed nickel, YY = polished nickel, TT = venetian bronze, VV = satin copper, II = mist, KM = black titanium, GG = gold

COMPONENTS

HAND SHOWER HOSES

BOY-2012-01-xx

CC	NN
150	195

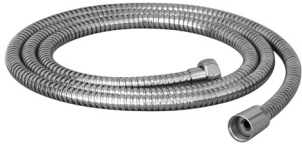

79" (200 cm) hand shower hose

- A- Conical nut 1/2" female
- B- 79" (200 cm) double interlock flexible hose, rotating nut with 2 non-return valves

BOY-2700-00-xx

CC	KK	LL	BB	NN/YY	VV/TT	II	KM	GG
120	156	180	180	156	192	180	192	264

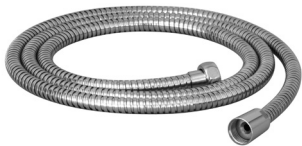

59" (150 cm) hand shower hose

- A- Conical nut 1/2" female
- B- 59" (150 cm) double interlock flexible hose, rotating nut with 2 non-return valves

Ecological options

Codes	Reduced flow rates
BOY-2700-00-xx-150	1.5 gpm (5.7 l/min) - 80 psi
BOY-2700-00-xx-175	1.75 gpm (6.6 l/min) - 80 psi

CEC

BOY-2800-00-xx

CC	KK
120	156



59" (150 cm) PVC hand shower hose

- A- Conical nut 1/2" female
- B- 59" (150 cm) flexible hose, rotating nut with 2 non-return valves

Ecological options

Codes	Reduced flow rates
BOY-2800-00-xx-150	1.5 gpm (5.7 l/min) - 80 psi
BOY-2800-00-xx-175	1.75 gpm (6.6 l/min) - 80 psi

CEC

Actual products may differ from pictures. Actual products measures may differ from the measures shown. All USD prices are subject to change without notice. Effective as of August 2023.

RAC-9001-13-xx

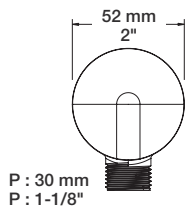

CC	KK	LL	BB	NN/YY	VV/TT	GG
88	114	132	132	114	141	194

Wall-mounted supply elbow

- A- 1/2" F NPT connection
- B- Brass elbow
- C- G 1/2" male water outlet

THE ESSENTIALS

RAC-9001-16-xx

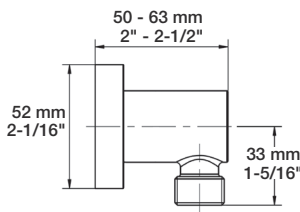

CC	KK	LL	BB	NN/YY	VV/TT	KM	GG
124	161	186	186	161	198	198	273

Wall-mounted supply elbow

- A- 1/2" F NPT connection
- B- Brass elbow
- C- G 1/2" male water outlet
- D- Adjustable depth

RAC-9001-18-xx

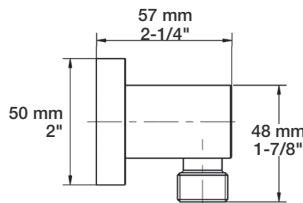

CC	KK	LL	BB	NN/YY	VV/TT	GG
144	187	216	216	187	230	317

Square wall-mounted supply elbow

- A- 1/2" F NPT connection
- B- Brass elbow
- C- G 1/2" male water outlet
- D- Adjustable depth

RAC-9001-19-xx

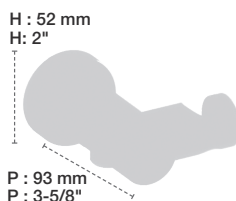
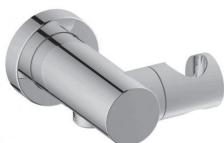

CC	KK	LL	BB	NN/YY	VV/TT	GG
174	226	261	261	226	278	383

Wall-mounted hand shower holder and supply elbow

- A- 1/2" F NPT connection
- B- Brass elbow
- C- Adjustable depth

RAC-9001-20-xx

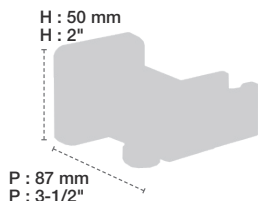
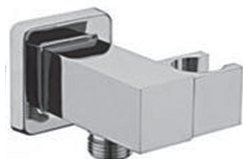

CC	KK	LL	BB	NN/YY	VV/TT	GG
222	289	333	333	289	355	488

Wall-mounted hand shower holder and supply elbow

- A- 1/2" F NPT connection
- B- Brass elbow
- C- Adjustable depth

RAC-9001-21-xx

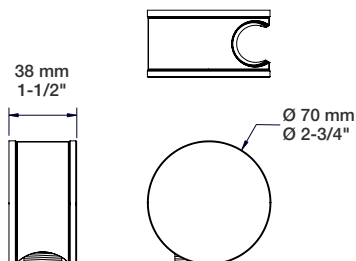

Cx	Kx	Lx	Bx	Nx/Yx	Vx/Tx	Gx
323	420	517	517	420	517	743

Wall-mounted hand shower holder and supply elbow

- A- 1/2" F NPT connection
- B- Brass elbow

x= color accent, see Flora B47 collection
Product shown here in CF

Finishes:

CC = chrome, KK = matte black, LL = satin brass, BB = white, NN = brushed nickel, YY = polished nickel, TT = venetian bronze, VV = satin copper, II = mist, KM = black titanium, GG = gold

COMPONENTS

WALL-MOUNTED SUPPLY ELBOW

THE ESSENTIALS

RAC-9001-26-xx

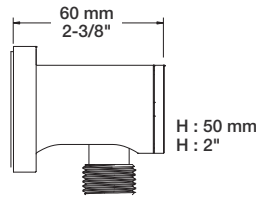

CC	KK
60	78

Wall-mounted 1/2" F supply elbow
A- Adjustable depth

RAC-9001-28-xx

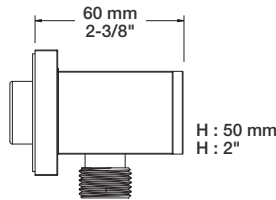
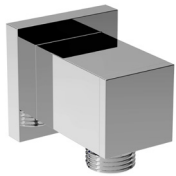

CC	KK
66	86

Square wall-mounted 1/2" F supply elbow
A- Adjustable depth

RAC-9201-02-xx

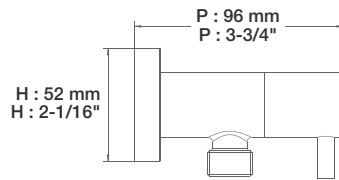

CC	KK	LL	BB	NN/YY	VV/TT	GG
199	259	299	299	259	318	438

Wall-mounted 1/2" F supply elbow with integrated volume control
A- 6.9 gpm - 60 psi
B- Volume control valve
C- Brass elbow
D- Can be used to replace a volume control valve and a wall-mounted supply elbow
E- CAR-1020-02

RAC-9402-14-xx

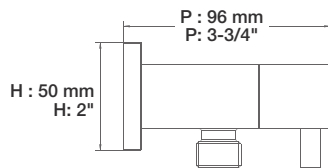
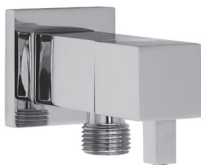

CC	KK	LL	BB	NN/YY	VV/TT	GG
224	291	336	336	291	358	493

Square wall-mounted 1/2" F supply elbow with integrated volume control
A- 6.9 gpm - 60 psi
B- Volume control valve
C- Brass elbow
D- Can be used to replace a volume control valve and a wall-mounted supply elbow
E- CAR-1020-02

SUP-1015-14-xx



CC	KK	LL	BB	NN/YY	VV/TT	GG
149	194	224	224	194	238	328

Wall-mounted hand shower support
A- Made of solid brass
B- Swivel hand shower bracket

Actual products may differ from pictures. Actual products measures may differ from the measures shown. All USD prices are subject to change without notice. Effective as of August 2023.

TET-0304-05-xx

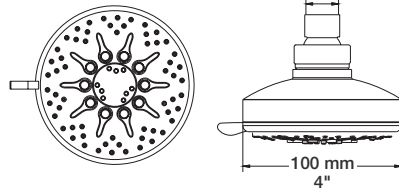

CC	KK	LL	BB	NN/YY	VV/TT	GG
129	168	194	194	168	206	284

5-spray anti-limestone modern shower head
A- 2 gpm - 80 psi

Ecological options

Codes	Reduced flow rates
TET-0304-05-xx-150	1.5 gpm (5.7 l/min) - 80 psi
TET-0304-05-xx-175	1.75 gpm (6.6 l/min) - 80 psi



THE ESSENTIALS

TET-0810-01-xx

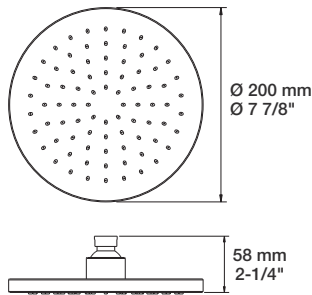

CC	KK	LL	BB	NN/YY	VV/TT	GG
445	579	668	668	579	712	979

Round 8" anti-limestone shower head
A- 2 gpm - 80 psi
B- Brass shower head

Ecological options

Codes	Reduced flow rates
TET-0810-01-xx-150	1.5 gpm (5.7 l/min) - 80 psi
TET-0810-01-xx-175	1.75 gpm (6.6 l/min) - 80 psi



TET-0811-02-xx

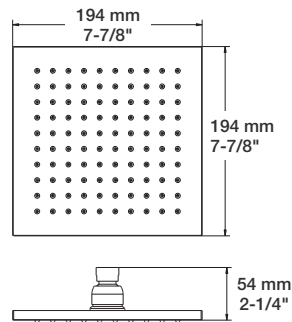

CC	KK	LL	BB	NN/YY	VV/TT	GG
460	598	690	690	598	736	1012

Square 8" anti-limestone shower head
A- 2 gpm - 80 psi
B- Brass shower head

Ecological options

Codes	Reduced flow rates
TET-0811-02-xx-150	1.5 gpm (5.7 l/min) - 80 psi
TET-0811-02-xx-175	1.75 gpm (6.6 l/min) - 80 psi



TET-0812-03-xx

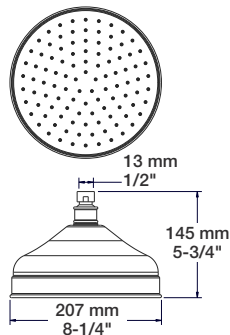

CC	KK	LL	BB	NN/YY	VV/TT	GG
495	644	743	743	644	792	1089

Sunflower 8" shower head
A- 2 gpm - 80 psi
B- Brass shower head

Ecological options

Codes	Reduced flow rates
TET-0812-03-xx-150	1.5 gpm (5.7 l/min) - 80 psi
TET-0812-03-xx-175	1.75 gpm (6.6 l/min) - 80 psi



TET-0813-01-xx

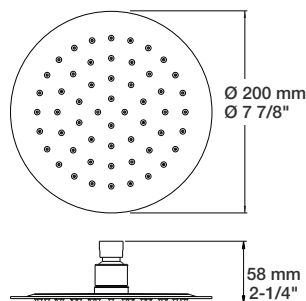

CC
310

Round 8" anti-limestone shower head
A- 2 gpm - 80 psi
B- Polished stainless steel thin shower head

Ecological options

Codes	Reduced flow rates
TET-0813-01-xx-150	1.5 gpm (5.7 l/min) - 80 psi
TET-0813-01-xx-175	1.75 gpm (6.6 l/min) - 80 psi



Finishes:

CC = chrome, KK = matte black, LL = satin brass, BB = white, NN = brushed nickel, YY = polished nickel, TT = venetian bronze, VV = satin copper, GG = gold

TET-0814-01-xx

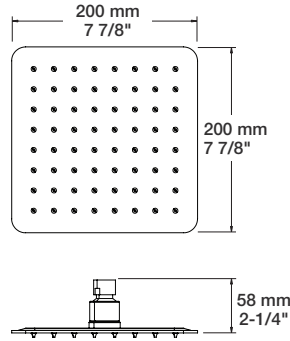
CC
330

Square 8" anti-limestone shower head

A- 2 gpm - 80 psi

B- Polished stainless steel thin shower head

Ecological options

Codes	Reduced flow rates
TET-0814-01-xx-150	1.5 gpm (5.7 l/min) - 80 psi
TET-0814-01-xx-175	1.75 gpm (6.6 l/min) - 80 psi

CEC
THE ESSENTIALS

CC	KK	LL	BB	NN/YY	VV/TT	KM	GG
460	598	690	690	598	736	736	1012

Rounded square 8" anti-limestone shower head

A- 2 gpm - 80 psi

B- Brass shower head

Ecological options

Codes	Reduced flow rates
TET-0815-01-xx-150	1.5 gpm (5.7 l/min) - 80 psi
TET-0815-01-xx-175	1.75 gpm (6.6 l/min) - 80 psi

CEC

TET-0815-01-xx

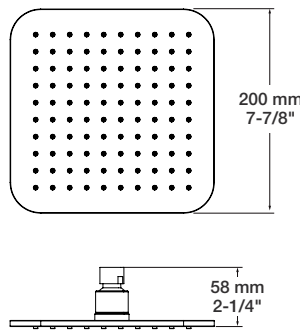

TET-1010-01-xx

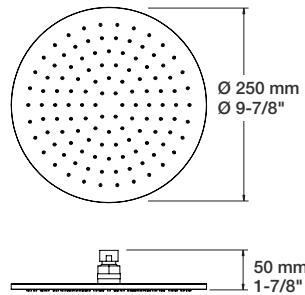

CC	KK	LL	BB	NN/YY	VV/TT	GG
575	748	863	863	748	920	1265

Round 10" anti-limestone shower head

A- 2 gpm - 80 psi

B- Brass shower head

Ecological options

Codes	Reduced flow rates
TET-1010-01-xx-150	1.5 gpm (5.7 l/min) - 80 psi
TET-1010-01-xx-175	1.75 gpm (6.6 l/min) - 80 psi

CEC

TET-1010-47-xx

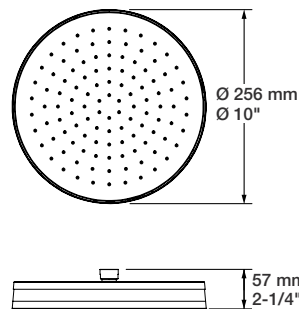
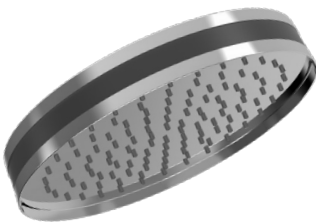

Cx	Kx	Lx	Bx	Nx/Yx	Vx/Tx	Gx
999	1299	1499	1499	1299	1598	2298

Flora round 10" anti-limestone shower head

A- 2 gpm - 80 psi

B- Brass shower head

Ecological options

Codes	Reduced flow rates
TET-1010-47-xx-150	1.5 gpm (5.7 l/min) - 80 psi
TET-1010-47-xx-175	1.75 gpm (6.6 l/min) - 80 psi

CEC

x= color accent, see Flora B47 collection
Product shown here in CF

TET-1011-01-xx

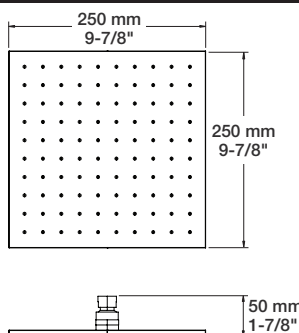
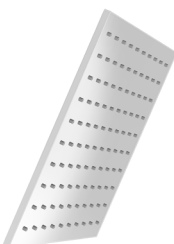

CC	KK	LL	BB	NN/YY	VV/TT	GG
630	819	945	945	819	1008	1387

Square 10" anti-limestone shower head

A- 2 gpm - 80 psi

B- Brass shower head

Ecological options

Codes	Reduced flow rates
TET-1011-01-xx-150	1.5 gpm (5.7 l/min) - 80 psi
TET-1011-01-xx-175	1.75 gpm (6.6 l/min) - 80 psi

CEC

Actual products may differ from pictures. Actual products measures may differ from the measures shown. All USD prices are subject to change without notice. Effective as of August 2023.

TET-1013-01-xx

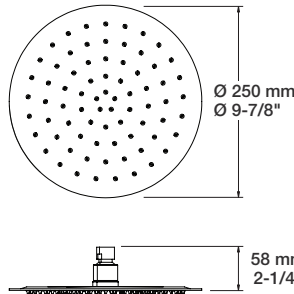

CC	KK
416	541

Round 10" anti-limestone shower head

A- 2 gpm - 80 psi
B- Polished stainless steel thin shower head

Ecological options

Codes	Reduced flow rates
TET-1013-01-xx-150	1.5 gpm (5.7 l/min) - 80 psi
TET-1013-01-xx-175	1.75 gpm (6.6 l/min) - 80 psi

TET-1014-01-xx

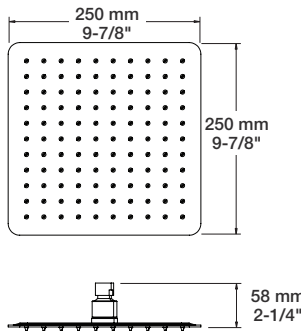
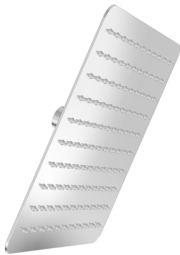

CC
439

Square 10" anti-limestone shower head

A- 2 gpm - 80 psi
B- Polished stainless steel thin shower head

Ecological options

Codes	Reduced flow rates
TET-1014-01-xx-150	1.5 gpm (5.7 l/min) - 80 psi
TET-1014-01-xx-175	1.75 gpm (6.6 l/min) - 80 psi

TET-1208-01-xx

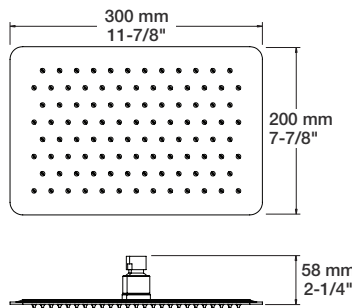

CC	KK
462	601

Rectangular 12" x 8" anti-limestone shower head

A- 2 gpm - 80 psi
B- Polished stainless steel thin shower head

Ecological options

Codes	Reduced flow rates
TET-1208-01-xx-150	1.5 gpm (5.7 l/min) - 80 psi
TET-1208-01-xx-175	1.75 gpm (6.6 l/min) - 80 psi

TET-1210-01-xx

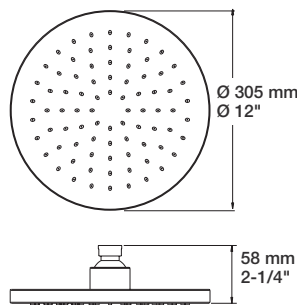

CC	KK	LL	BB	NN/YY	VV/TT	GG
750	975	1125	1125	975	1200	1650

Round 12" anti-limestone shower head

A- 2 gpm - 80 psi
B- Brass shower head

Ecological option

Code	Reduced flow rate
TET-1210-01-xx-175	1.75 gpm (6.6 l/min) - 80 psi

TET-1212-04-xx

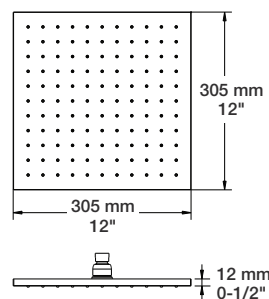
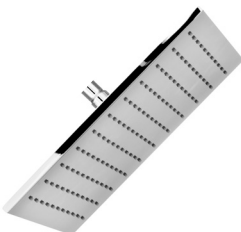

CC	KK	LL	BB	NN/YY	VV/TT	GG
825	1073	1238	1238	1073	1320	1815

Square 12" anti-limestone shower head

A- 2 gpm - 80 psi
B- Brass shower head

Ecological option

Code	Reduced flow rate
TET-1212-04-xx-175	1.75 gpm (6.6 l/min) - 80 psi

Finishes:

CC = chrome, KK = matte black, LL = satin brass, BB = white, NN = brushed nickel, YY = polished nickel, TT = venetian bronze, VV = satin copper, KM = black titanium, GG = gold

COMPONENTS

SHOWER HEADS

TET-1213-01-xx

CC

572

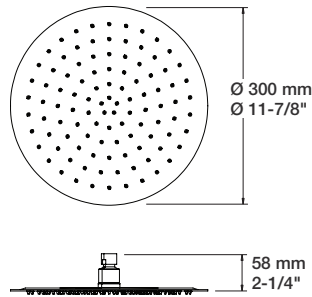

Round 12" anti-limestone shower head

- A- 2 gpm - 80 psi
- B- Polished stainless steel thin shower head

Ecological option

Code	Reduced flow rate
TET-1213-01-xx-175	1.75 gpm (6.6 l/min) - 80 psi

CEC

TET-1214-01-xx

CC

595

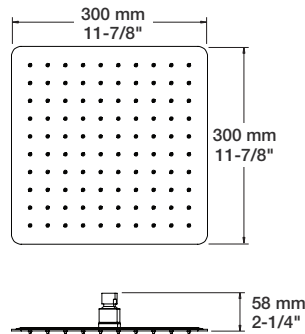
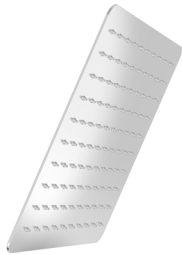

Square 12" anti-limestone shower head

- A- 2 gpm - 80 psi
- B- Polished stainless steel thin shower head

Ecological option

Code	Reduced flow rate
TET-1214-01-xx-175	1.75 gpm (6.6 l/min) - 80 psi

CEC

TET-1214-91-xx

CC

763

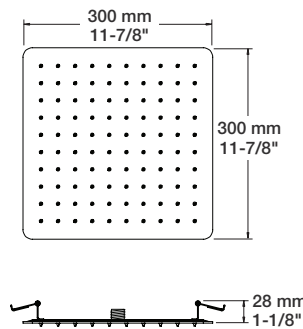

Square 12" anti-limestone built-in shower head

- A- 2 gpm - 80 psi
- B- Polished stainless steel thin shower head

Ecological option

Code	Reduced flow rate
TET-1214-91-xx-175	1.75 gpm (6.6 l/min) - 80 psi

CEC

TET-1613-01-xx

CC

809

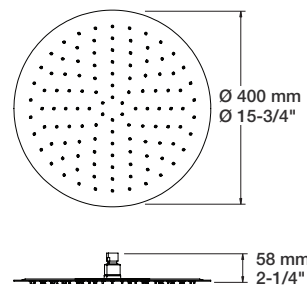

Round 16" anti-limestone shower head

- A- 2 gpm - 80 psi
- B- Polished stainless steel thin shower head
- C- Install with a straight ceiling mount only

Ecological option

Code	Reduced flow rate
TET-1613-01-xx-175	1.75 gpm (6.6 l/min) - 80 psi

CEC

TET-1614-01-xx

CC

832

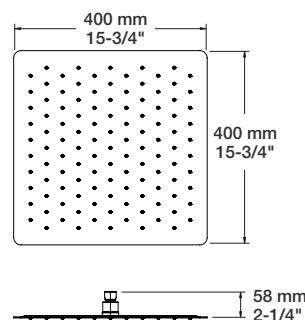
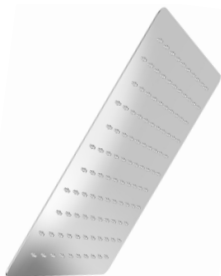

Square 16" anti-limestone shower head

- A- 2 gpm - 80 psi
- B- Polished stainless steel thin shower head
- C- Install with a straight ceiling mount only

Ecological option

Code	Reduced flow rate
TET-1614-01-xx-175	1.75 gpm (6.6 l/min) - 80 psi

CEC

Actual products may differ from pictures. Actual products measures may differ from the measures shown. All USD prices are subject to change without notice. Effective as of August 2023.

TET-1614-91-xx

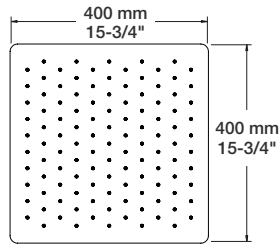

CC
1006

Square 16" anti-limestone built-in shower head
A- 2 gpm - 80 psi
B- Polished stainless steel thin shower head

Ecological option

Code	Reduced flow rate
TET-1614-91-xx-175	1.75 gpm (6.6 l/min) - 80 psi

TET-1616-01-xx

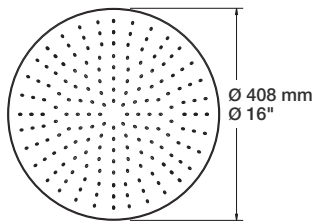

CC	KK	LL	BB	NN/YY	VV/TT	GG
1195	1554	1793	1793	1554	1912	2629

Round 16" anti-limestone shower head
A- 2 gpm - 80 psi
B- Brass shower head
C- Install with a straight ceiling mount only

Ecological option

Code	Reduced flow rate
TET-1616-01-xx-175	1.75 gpm (6.6 l/min) - 80 psi

TET-1616-02-xx

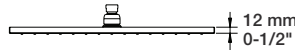
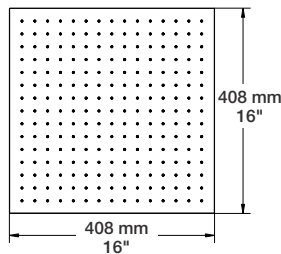
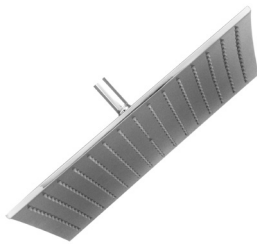

CC	KK	LL	BB	NN/YY	VV/TT	GG
1295	1684	1943	1943	1684	2072	2849

Square 16" anti-limestone shower head
A- 2.5 gpm - 80 psi
B- Brass shower head
C- Install with a straight ceiling mount only

TET-2012-01-xx

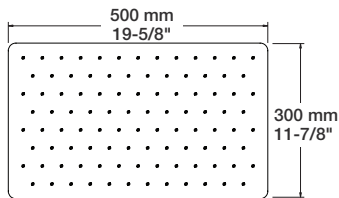
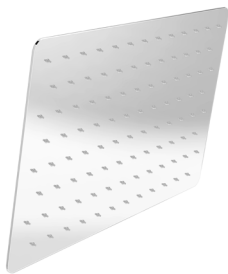

CC
965

Rectangular 20" x 12" anti-limestone shower head
A- 2 gpm - 80 psi
B- Polished stainless steel thin shower head

Ecological option

Code	Reduced flow rate
TET-2012-01-xx-175	1.75 gpm (6.6 l/min) - 80 psi

TET-3018-01-xx

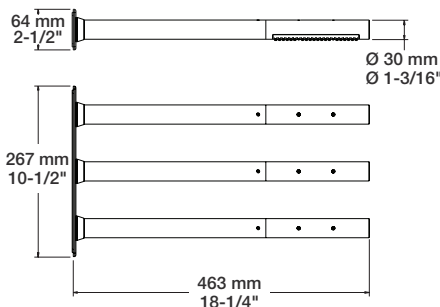

CC/CF	KK	LL	BB	NN/YY	VV/TT	GG
1395	1814	2093	2093	1814	2232	3069

Adjustable 3-stem shower head
A- 3 adjustable brass shower heads
B- 2 gpm - 80 psi
C- Wall plate for shower heads included
D- 2 choices of installation: with or without wall plate

Ecological option

Code	Reduced flow rate
TET-3018-01-xx-175	1.75 gpm (6.6 l/min) - 80 psi

Finishes:

CC = chrome, CF = smokey chrome, KK = matte black, LL = satin brass, BB = white, NN = brushed nickel, YY = polished nickel, TT = venetian bronze, VV = satin copper, GG = gold

COMPONENTS

SHOWER ARMS

BRA-0612-02-xx

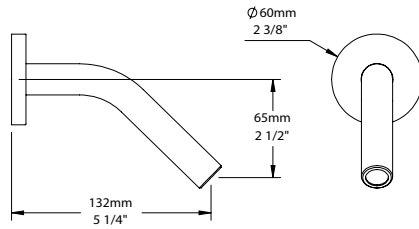

CC	KK	LL	BB	NN/YY	VV/TT	GG
61	79	92	92	79	98	134

6" wall-mounted shower arm
A- 1/2" M NPT connection

BRA-0612-14-xx

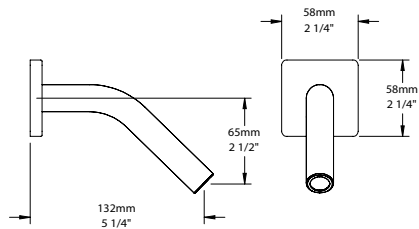

CC	KK	LL	BB	NN/YY	VV/TT	GG
91	118	137	137	118	146	200

6" wall-mounted shower arm, square flange
A- 1/2" M NPT connection

BRA-1212-02-xx

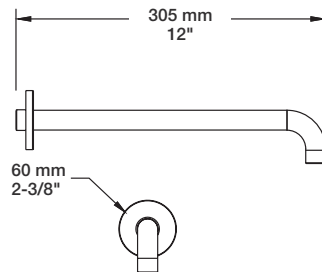

CC	KK	LL	BB	NN/YY	VV/TT	GG
124	161	186	186	161	198	273

12" wall-mounted shower arm
A- 1/2" M NPT connection

BRA-1212-14-xx

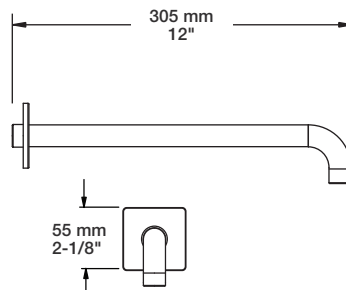

CC	KK	LL	BB	NN/YY	VV/TT	GG
154	200	231	231	200	246	339

12" wall-mounted shower arm, square flange
A- 1/2" M NPT connection

BRA-1409-02-xx

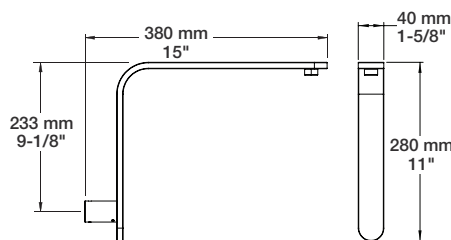

CC	KK	LL	BB	NN/YY	VV/TT	GG
314	408	471	471	408	502	691

15" L-shaped wall-mounted shower arm
A- 1/2" F NPT connection
B- Ø 2" optional round flange

Actual products may differ from pictures. Actual products measures may differ from the measures shown. All USD prices are subject to change without notice. Effective as of August 2023.

BRA-1608-00-xx

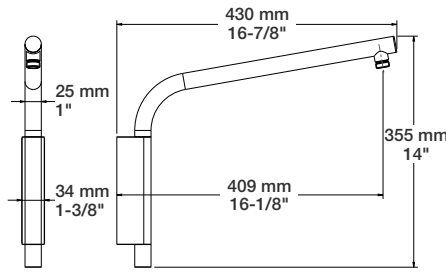

CC	KK	LL	BB	NN/YY	VV/TT	GG
368	478	552	552	478	589	810

17" L-shaped wall-mounted shower arm
A- 1/2" F NPT connection

BRA-1612-44-xx

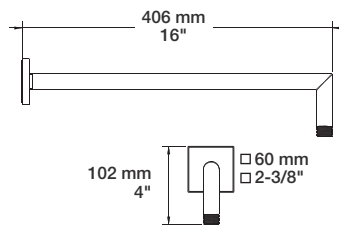

CC	KK	LL	BB	NN/YY	VV/TT	GG
199	259	299	299	259	318	438

16" wall-mounted shower arm, square flange
A- 1/2" M NPT connection

BRA-1612-66-xx

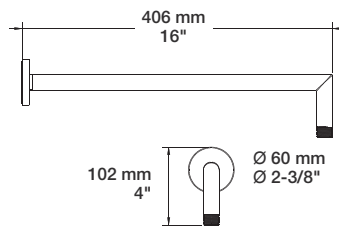

CC	KK	LL	BB	NN/YY	VV/TT	KM	GG
179	233	269	269	233	286	286	394

16" wall-mounted shower arm
A- 1/2" M NPT connection

BRA-1614-04-xx

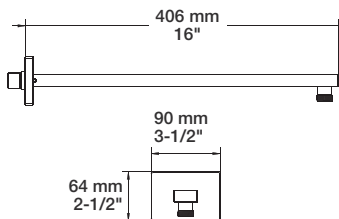

CC	KK	LL	BB	NN/YY	VV/TT	GG
324	421	486	486	421	518	713

16" rectangular wall-mounted shower arm
A- 1/2" F NPT connection

BRA-1812-02-xx

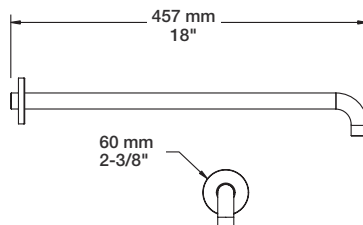

CC	KK	LL	BB	NN/YY	VV/TT	GG
168	218	252	252	218	269	370

18" wall-mounted shower arm
A- 1/2" M NPT connection

Finishes:

CC = chrome, KK = matte black, LL = satin brass, BB = white, NN = brushed nickel, YY = polished nickel, TT = venetian bronze, VV = satin copper, KM = black titanium, GG = gold

COMPONENTS

SHOWER ARMS

BRA-1812-14-xx

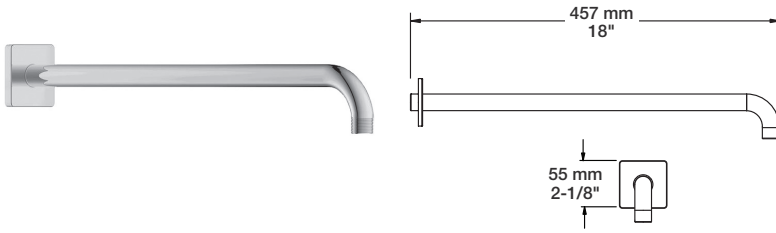

CC	KK	LL	BB	NN/YY	VV/TT	GG
188	244	282	282	244	301	414

18" wall-mounted shower arm, square flange
A- 1/2" M NPT connection

BRA-1815-02-xx

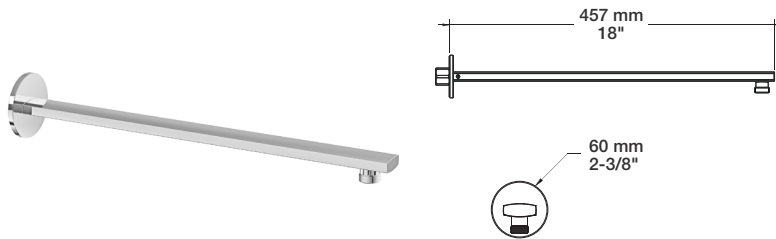

CC	KK	LL	BB	NN/YY	VV/TT	GG
325	423	488	488	423	520	715

18" wall mounted shower arm
A- 1/2" F NPT connection

BRA-1816-02-xx

Available
Q3 2023

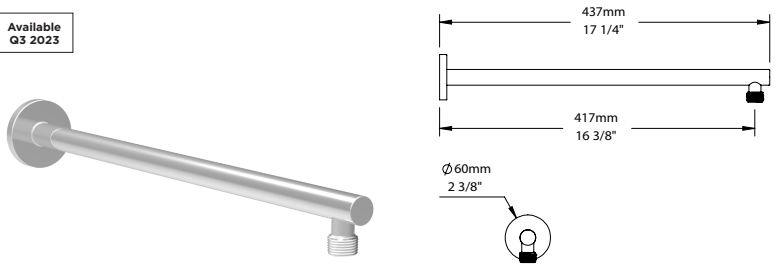

CC	KK	LL	BB	NN/YY	VV/TT	GG
225	293	338	338	293	360	495

18" wall mounted shower arm
A- 1/2" M NPT connection

Actual products may differ from pictures. Actual products measures may differ from the measures shown. All USD prices are subject to change without notice. Effective as of August 2023.

RAC-0318-02-xx

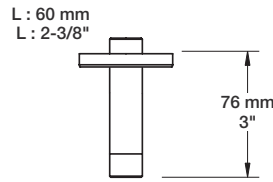

CC	KK	LL	BB	NN/YY	VV/TT	GG
58	75	87	87	75	93	145

3" ceiling mounted shower arm
A- 1/2" M NPT connection

RAC-0318-14-xx

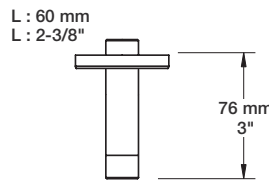

CC	KK	LL	BB	NN/YY	VV/TT	GG
98	127	147	147	127	157	216

3" ceiling mounted shower arm, square flange
A- 1/2" M NPT connection

RAC-0618-02-xx

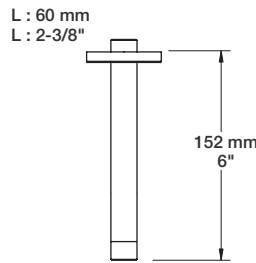

CC	KK	LL	BB	NN/YY	VV/TT	KM	GG
68	88	102	102	88	109	109	170

6" ceiling mounted shower arm
A- 1/2" M NPT connection

RAC-0618-14-xx

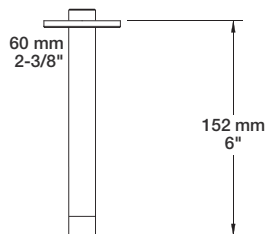

CC	KK	LL	BB	NN/YY	VV/TT	GG
108	140	162	162	140	173	238

6" ceiling mounted shower arm, square flange
A- 1/2" M NPT connection

RAC-0918-02-xx

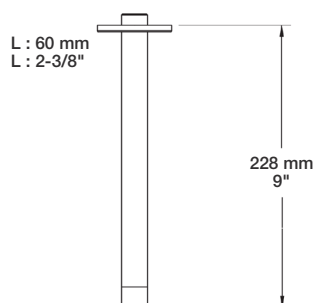

CC	KK	LL	BB	NN/YY	VV/TT	GG
99	129	149	149	129	158	218

9" ceiling mounted shower arm
A- 1/2" M NPT connection

Finishes:

CC = chrome, KK = matte black, LL = satin brass, BB = white, NN = brushed nickel, YY = polished nickel, TT = venetian bronze, VV = satin copper, KM = black titanium, GG = gold

COMPONENTS

CONNECTORS

RAC-0918-14-xx

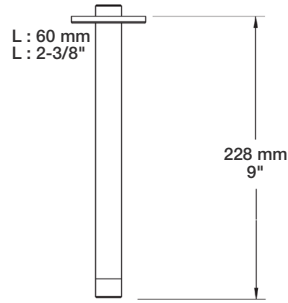

CC	KK	LL	BB	NN/YY	VV/TT	GG
149	194	224	224	194	238	328

9" ceiling mounted shower arm, square flange
A- 1/2" M NPT connection

RAC-1218-02-xx

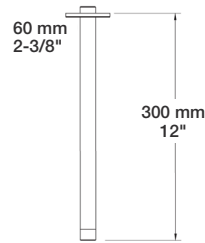

CC	KK	LL	BB	NN/YY	VV/TT	GG
134	174	201	201	174	214	295

12" ceiling mounted shower arm
A- 1/2" M NPT connection

RAC-1218-14-xx

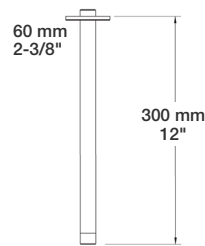

CC	KK	LL	BB	NN/YY	VV/TT	GG
174	226	261	261	226	278	383

12" ceiling mounted shower arm, square flange
A- 1/2" M NPT connection

Actual products may differ from pictures. Actual products measures may differ from the measures shown. All USD prices are subject to change without notice. Effective as of August 2023.

BEC-0520-22-xx

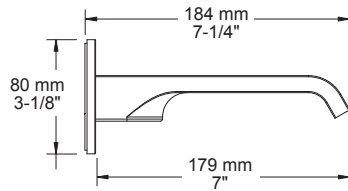

CC	KK	LL	BB	NN/YY	VV/TT	GG
312	406	468	468	406	499	686

Cascade-type tub spout without diverter

A- Slip-on installation
B- Cascade stream

BEC-0520-26-xx

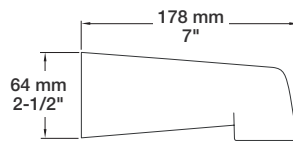

CC	KK	LL	BB	NN/YY	VV/TT	GG
99	129	149	149	129	158	218

7" tub spout without diverter

A- Slip-on installation
B- Cascade stream

THE ESSENTIALS

BEC-0520-37-xx

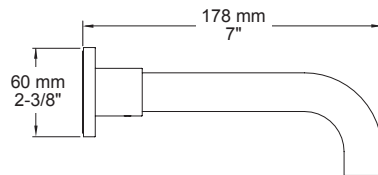

CC	KK	LL	BB	NN/YY	VV/TT	GG
219	285	329	329	285	350	482

Round modern tub spout without diverter 1/2" F

A- Cascade stream
B- 1/2" F NPT connection

BEC-0520-39-xx

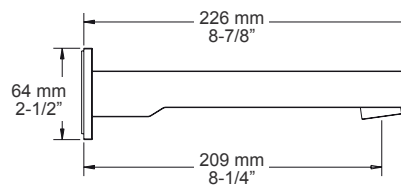

CC	KK	LL	BB	NN/YY	VV/TT	GG
359	467	539	539	467	574	790

Square modern tub spout without diverter

A- Slip-on installation
B- Laminar stream

THE ESSENTIALS

BEC-0520-45-xx

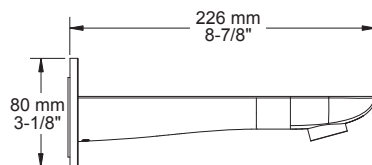

CC	KK	LL	BB	NN/YY	VV/TT	GG
424	551	636	636	551	678	933

Sens tub spout without diverter

A- Slip-on installation
B- Laminar stream

Finishes:

CC = chrome, KK = matte black, LL = satin brass, BB = white, NN = brushed nickel, YY = polished nickel, TT = venetian bronze, VV = satin copper, GG = gold

COMPONENTS

TUB SPOUTS

THE ESSENTIALS

BEC-0520-46-xx

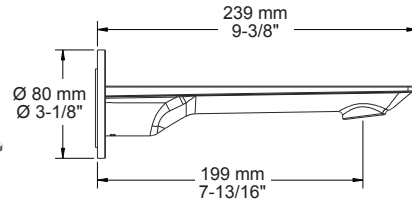
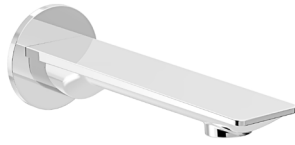

CC	KK	LL	BB	NN/YY	VV/TT	KM	GG
434	564	651	651	564	694	694	955

Profile tub spout without diverter

- A- Slip-on installation
- B- Laminar stream

BEC-0520-51-xx

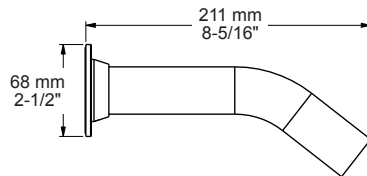

CC/CF	KK	LL	BB	NN/YY	VV/TT	GG
319	415	479	479	415	510	702

MA tub spout without diverter

- A- Slip-on installation
- B- Laminar stream

BEC-0520-73-xx

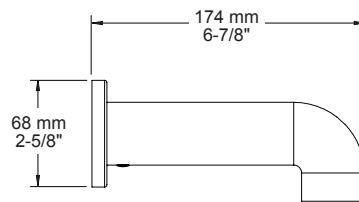

CC	KK	LL	BB	NN/YY	VV/TT	KM	GG
168	218	252	252	218	269	269	370

Round 7" tub spout without diverter

- A- Slip-on installation
- B- Laminar stream

BEC-0520-74-xx

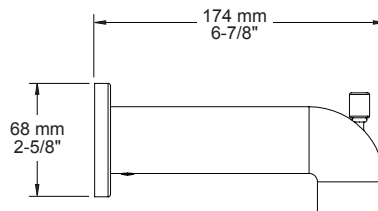

CC	KK	LL	BB	NN/YY	VV/TT	GG
198	257	297	297	257	317	436

Round 7" tub spout with diverter

- A- Slip-on installation
- B- Laminar stream

BEC-0520-83-xx

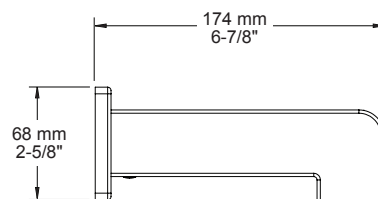
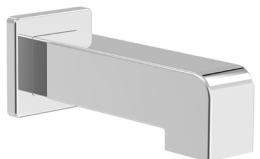

CC	KK	LL	BB	NN/YY	VV/TT	GG
198	257	297	297	257	317	436

Square 7" tub spout without diverter

- A- Slip-on installation
- B- Laminar stream

Actual products may differ from pictures. Actual products measures may differ from the measures shown. All USD prices are subject to change without notice. Effective as of August 2023.

BEC-0520-84-xx

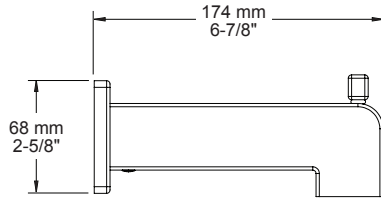
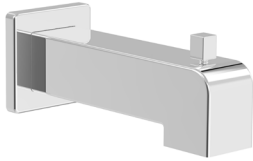

CC	KK	LL	BB	NN/YY	VV/TT	GG
228	296	342	342	296	365	502

Square 7" tub spout with diverter

- A- Slip-on installation
- B- Laminar stream

Finishes:

CC = chrome, CF = smokey chrome, KK = matte black, LL = satin brass, BB = white, NN = brushed nickel, YY = polished nickel, TT = venetian bronze, VV = satin copper, KM = black titanium, GG = gold

COMPONENTS

BODY JETS

BOD-5001-00-xx

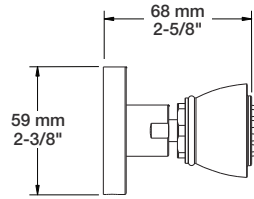

CC	KK	LL	BB	NN/YY	VV/TT	GG
139	181	209	209	181	222	306

Lateral body jet

A- 2 gpm - 80 psi
B- Swivel body jet

Ecological options

Codes	Reduced flow rates
BOD-5001-00-xx-150	1.5 gpm (5.7 l/min) - 80 psi
BOD-5001-00-xx-175	1.75 gpm (6.6 l/min) - 80 psi

BOD-5002-01-xx

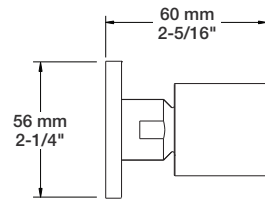

CC	KK	LL	BB	NN/YY	VV/TT	GG
199	259	299	299	259	318	438

Cylindrical lateral body jet

A- 2 gpm - 80 psi
B- Swivel body jet

Ecological options

Codes	Reduced flow rates
BOD-5002-01-xx-150	1.5 gpm (5.7 l/min) - 80 psi
BOD-5002-01-xx-175	1.75 gpm (6.6 l/min) - 80 psi

BOD-5004-02-xx

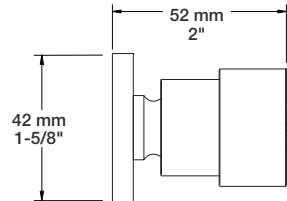

CC	KK	LL	BB	NN/YY	VV/TT	GG
248	322	372	372	322	397	546

Square lateral body jet

A- 2 gpm - 80 psi
B- Swivel body jet

Ecological options

Codes	Reduced flow rates
BOD-5004-02-xx-150	1.5 gpm (5.7 l/min) - 80 psi
BOD-5004-02-xx-175	1.75 gpm (6.6 l/min) - 80 psi

BOD-5006-01-xx

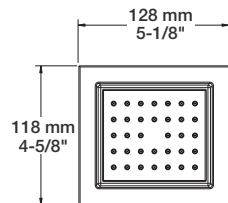
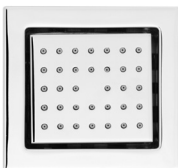

CC	KK	LL	BB	NN/YY	VV/TT	GG
350	455	525	525	455	560	770

Square built-in lateral body jet

A- 2 gpm - 80 psi
B- Swivel body jet

Ecological options

Codes	Reduced flow rates
BOD-5006-01-xx-175	1.75 gpm (6.6 l/min) - 80 psi

BOD-5007-01-xx

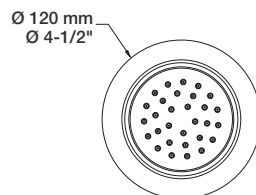

CC	KK	LL	BB	NN/YY	VV/TT	GG
325	423	488	488	423	520	715

Round built-in lateral body jet

A- 2 gpm - 80 psi
B- Swivel body jet

Ecological options

Codes	Reduced flow rates
BOD-5007-01-xx-150	1.5 gpm (5.7 l/min) - 80 psi
BOD-5007-01-xx-175	1.75 gpm (6.6 l/min) - 80 psi

Actual products may differ from pictures. Actual products measures may differ from the measures shown. All USD prices are subject to change without notice. Effective as of August 2023.

EXT-2600-01

102



Fittings for external thermostatic valve

A- Extension may be cut to the required length
B- 1/2" F NPT connection

EXT-3404-00-xx



CC	KK	LL	BB	NN/YY	VV/TT	GG
160	208	240	240	208	256	352

1-3/8" decorative extension for thick wall or to correct deep rough-ins

A- For rough valve RVA-3404-00-B only

EXT-9520-30-xx



CC	KK	LL	BB	NN/YY	VV/TT	GG
299	389	449	449	389	478	658

1-3/8" decorative extension for thick wall or to correct deep rough-ins

A- For the following rough valves:
RVA-9521-x0-B, RVA-9521-x0-NS-B,
RVA-9531-x0-B, RVA-9531-x0-NS-B

KIT-9034-12-xx

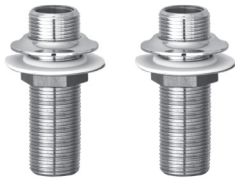

CC	KK	LL	BB	NN/YY	VV/TT	GG
168	218	252	252	218	269	370

Wall fixture kit

A- Can be used when installing an external thermostatic valve if the fixation wall is thin
B- 1/2" F NPT connection

Finishes:

CC = chrome, KK = matte black, LL = satin brass, BB = white, NN = brushed nickel, YY = polished nickel, TT = venetian bronze, VV = satin copper, GG = gold

General Information

Authorized retailer for BARIL

To be an authorized retailer for BARIL, a retailer must:

- Be in a non protected territory
- Have a showroom that represents BARIL's standards
- Be accepted as an authorized retailer by BARIL's management
- Present a minimum of 20 BARIL products in the showroom
- Obtain credit approval
- Present the image and visual of BARIL
- Offer an acceptable discount to its customers

Terms and conditions

Price: The prices are subject to change without notice. Taxes will be added if applicable.

Terms of payment: Payment terms are net 30 days. An interest charge of 2% per month (24% per year) will be charged on late payments. No delivery will be made to clients who don't comply with the terms of payment.

Delivery: Prices are F.O.B. from our warehouses. BARIL's responsibility ends when the merchandise is given to the carrier. Shipping claims must be made by the retailer.

Merchandise return:

- Merchandise can't be returned without BARIL's authorization
- BARIL reserves the right to refuse a merchandise return at all times
- A 25% return fee will be charged to the client
- Merchandise must be returned in its original packaging
- Merchandise must not be damaged
- Parts with a manufacturing defect will be replaced at no charge
- BARIL will replace or repair the defective part at its discretion

Recommendations:

BARIL recommends the use of services offered by a professional plumber for any installation or repair work. BARIL recommends that products be wiped dry after each use with a soft dry cloth to prevent water-spotting and mineral build-up.

Do not allow water to come into prolonged contact with faucet's surface, wipe down after each use. Do not allow water to accumulate at base of faucet.

BARIL recommends that products be cleaned with a mild, non-abrasive liquid soap, warm water and soft cloth.

Never use abrasive products, chemicals, corrosives that are very strong or in powder form, including toothpaste, detergents, scouring products, window cleaners and disinfectants.

Failure to give the faucet the proper care may void the warranty.

Care Instructions

To keep your BARIL faucet looking its best, please follow these simple care instructions:

Do:

1. Rinse the faucet with clear water.
2. Dry the faucet with a soft cotton cloth.

Regular and routine cleaning will allow you to maintain your faucet in good condition. Wipe dry after each use with a soft dry cotton cloth to prevent water-spotting and mineral build-up.

If heavy cleaning is required, the following procedures are recommended:

1. Remove surface dirt and film using clear water and a soft cotton cloth.
2. To remove tough surface film and build-up dirt, use a non-acidic, non-abrasive gentle liquid soap without detergent.
3. Once clean, rinse faucet with clear water to thoroughly remove cleaner and blot dry with a soft cotton cloth.

While all BARIL finishes are designed for maximum durability, failure to give your faucet the proper care may void the warranty. As a result, here are a few helpful tips:

Do not:

1. Use abrasive cloths, cleaning pads or paper towels.
2. Use any abrasive cleansers (like Vim®, etc.).
3. Use any cleaning agents containing acids, polish, waxes, alcohol, ammonia, bleach, solvents or any other corrosive or harsh chemical cleansers.
4. Allow water to come into prolonged contact with faucet surface or to accumulate at base of faucet: preferably wipe down after each use.

Special finishes:

24K gold is a precious and soft finish, which must be treated gently, like you would treat fine jewelry.

The other special finishes like nickel, copper, bronze, matte black, etc. are unique handcrafted finishes, created so no two finishes look exactly alike. They are living finishes, and you will be able to admire their unique look and nice aging over time.

Follow all the recommendations listed above and make sure to wipe dry after each use with a soft dry cotton cloth.

Thanks to proper care, you will enjoy the glance of BARIL faucets for years.

Warranty

BARIL offers a limited lifetime warranty on all of its products¹ against any defect affecting materials or any manufacturing defect. This warranty is offered and will benefit only the original purchaser of the product, for as long as such person remains the owner of the residence of the original installation and of the product. This warranty covers residential and multi-residential projects².

The BARIL warranty covers all finishes as long as the product has been used under normal conditions and by strictly applying the maintenance conditions described on the website at barildesign.com/maintenance.

Proof of purchase or the original purchase invoice must accompany any claim submitted to BARIL.

BARIL agrees, following its analysis, to provide as a replacement, as the case may be, one or more spare parts or the same product (or, if it is no longer available, a comparable product of equivalent value).

BARIL recommends retaining the services of a professional installer, competent and able to carry out the installation strictly and only according to the instructions provided by the manufacturer.

The owner-user is responsible for access to the residence for the installation or repair of the product. BARIL's aggregate obligation under this warranty shall in no event exceed the original purchase price of the faucet.

*Limitations:

- This warranty is limited to original BARIL products purchased from an **authorized BARIL retailer**.
- **All electrical and/or electronic parts and/or components are covered by a limited five (5) year warranty.** Batteries are excluded from any BARIL's warranty.

- The warranty period for any product installed as part of a **hospitality project (hotel, restaurant, spa, gym) is (1) one year** from the original purchase date from an authorized BARIL retailer/distributor.
- This warranty is **not transferable**.

*The warranty does not cover:

- Any BARIL product cleaned with abrasive, irritating or corrosive products or more generally any product not specifically recommended for cleaning faucets;
- Any BARIL product that has **not been installed in accordance with the manufacturer's instructions and the applicable laws and codes** in force;
- Normal wear of components and finishes;
- Any **application and/or use of an industrial, institutional or commercial type not expressly mentioned above³**;
- Damage caused by or originating from:
 - The presence of hard water, lime deposits or sediment;
 - The storage of any cleaning product - household or industrial - regardless of its chemical composition or content, in the immediate environment of the BARIL product, including cabinets and vanities located under the sink and plumbing fixtures, these cleaning products may attack and corrupt the integrity of the plumbing fixtures, including their various components;
 - A disaster, natural or not, such as fire, flood, earthquake, thunder, electrical storm or any other phenomenon of the same nature;
 - Hot water with a temperature above 158°F (70°C) and/or water pressure at the tap exceeding 5.5 bars (80 psi);
 - Freezing and/or clogging of supply pipes;
 - Any other case resulting from a lack of use, negligent or abusive, or maintenance of BARIL products;

- Installation error, negligence or abusive use.
- Any BARIL product installed **outdoors** (outside a residence);
- Any BARIL products installed **outside of North America**;
- Any claim including false information, false and/or misleading statements, or voluntary or involuntary omissions about the context of the claim and/or installation of the product;
- BARIL is not responsible for any damages, losses, injuries, or costs of any kind, indirect, incidental, or consequential, including, but not limited to, loss of use, related to parts and/or products from BARIL.

Notes and definitions:

¹ The BARIL PRO line of products is covered by a separate warranty available at barilpro.com/warranty.

² "RESIDENTIAL AND MULTI-RESIDENTIAL" define and include:

- Owner-occupied houses and condos;
- Rental condos and apartments with a long-term lease of 12 months;
- Residential rental apartments for elderly people, excluding common and public areas, as well as kitchen and dining areas.

³ "INDUSTRIAL, INSTITUTIONAL AND COMMERCIAL" define and include:

- Buildings or establishments for commercial use, where transactions are carried out with clients;
- Health network establishments (hospitals, CLSCs, medical clinics, health professionals' offices);
- Industrial establishments (e.g. warehouses, distribution centres, production plants, etc.);
- Office buildings;
- Any other public area using sanitary facilities.

Legal provisions:

This warranty excludes all other warranties, including, but not limited to, any mandatory warranties that relate to merchantability or fitness for use. This warranty and its limitations and exclusions may not apply to you or may apply in addition to other rights and remedies due to legal provisions applicable in certain states, provinces or countries.

Notwithstanding any provision of this warranty, BARIL shall not be liable for any punitive, special, incidental or consequential damages arising out of or in any way related to BARIL products, whether under contract, warranty, tort, statute or otherwise. Excluded damages include, but are not limited to, damages for loss of use, loss of time, inconvenience, impairment or any other loss howsoever arising. THE EXCLUSION OF INCIDENTAL AND CONSEQUENTIAL DAMAGES PROVIDED HEREIN SHALL APPLY NOTWITHSTANDING ANY OTHER TERMS OF THIS WARRANTY AND SHALL APPLY TO ALL WARRANTIES, REMEDIES AND OTHER TERMS OF THIS WARRANTY. This disclaimer shall not be construed as affecting in any way BARIL's obligations, if any, with respect to third-party claims for property damage, personal injury or death. This warranty shall not be construed as conferring any rights with respect to the foregoing.

BARIL accepts no responsibility for any labor or shipping costs as well as any damage in whole or in part caused by the improper installation of the product, its removal, its reinstallation or its repair or caused to the product as a result of the use of one or more spare parts other than BARIL's original parts. BARIL is not responsible for costs related to an installation that does not comply with the laws and codes in force at the place of installation.

The owner-user will remain solely responsible for all claims, damages, losses, liabilities, obligations and judgments, of whatever nature, including all costs and expenses, including costs and reasonable attorneys' fees relating thereto (hereinafter, collectively, "claims"), related to the BARIL product, which arises on or after the original date of purchase (including, but not limited to, any replacement parts) and during the period during which the owner-user remains the owner of the BARIL product and the residence of the original installation, and which derives directly or indirectly, in any way, from (a) the ownership of the BARIL product by the owner-user or after it, or (b) the use, possession, dispossession, repossession, control, operation or location of the BARIL product by the user owner or by a third party on the original date of purchase or after it, or (c) any condition or defect in the BARIL product, whether concealed or not, regardless of when such defect is discovered, but only with respect to claims for material damage or bodily injury are not actionable prior to the original date of purchase, to the extent such condition arose, or was discovered or reported, on or after the original date of purchase. The foregoing indemnity applies to all claims for which the owner-user is liable under the preceding sentence, whether such claims are in tort (including, but not limited to, strict liability).

Customer Service Policies

After more than 35 years in the industry, BARIL is well known for the quality of its products and the excellence of its after-sale customer service.

Technical support

BARIL endorses the quality of its products. If you are facing any difficulties, you can call us at 1.800.463.3871 or write us at info@barildesign.com and it will be our pleasure to help you find solutions. Indeed, for any questions on our products, on installation, on different technical problems you may encounter, etc., our experts will be happy to help you. Our customer service team is trained by our products' experts who conceived those products. They know how to support you and provide you with an excellent service.

Parts box

BARIL's authorized retailers can receive a parts box. It will be personalized according to your purchases and will provide you the most needed parts. The replacement parts are distributed free of charge to enable you to offer an excellent after-sale service to your customers.

For parts replacement, BARIL's sales representative will make sure to take back the defective parts and replace them if needed. All defective parts will be exchanged free of charge.

It is important to keep, at all times, the defective parts returned by your customer. Only parts with manufacturing defect will be replaced free of charge.

Service call policy

In order to offer you the best after-sale service possible, here is how to proceed when making a service call. We remind you that BARIL is only responsible for the cost of the parts and does not cover fees related to products being installed and/or uninstalled.

Not only do you have the support of our representatives, but our technical service is always ready to help you with the installation or repair of a product. To make sure you get a quick answer, here is how to proceed when making a service call:

1. For each service call, please fill out the service call form with as much details as possible concerning the problem, diagnosis or solution;
2. Send the form by fax at the following number: 1.877.693.3005 or by e-mail at the following address: info@barildesign.com and remember to give us all the necessary information;
3. Please send your customer's invoice with the exact product's code as well as the exact date of purchase along with the form;
4. Our employee will take the dispositions needed to accommodate your client. If the situation needs an immediate action, please specify it on the document. All service calls will be answered within 48 hours, from Monday to Friday;
5. If a replacement part is needed, it will be sent to the distributor under the name of the consumer;
6. If necessary, we will contact the consumer directly in order to help him solve his problem;
7. In the most extreme cases, a BARIL representative could go on site to evaluate the situation. If this happens and the problem is not due to a manufacturing defect of a BARIL product, the client will be charged a 50\$ fee;
8. If requested, the form will be returned to you with the confirmation of the repairs being done and the closing of the file.

For any other information, you can contact our technical department at 1.800.463.3871 or at info@barildesign.com.

With the desire to keep a strong partnership with our privileged clients, we know this procedure will assure you a quality after-sale service.

**Thank you for your trust,
BARIL**

Service Call Form

Customer

Store

.....
Name

.....
Name

.....
Address

.....
Address

.....
Phone

.....
Phone

.....
Fax

.....
Fax

.....
Contact

.....
Contact

.....
BARIL can contact the
end user

Yes

No

.....
Emergency

.....
Problem
description

Following the validation of the situation, the fees related will be charged directly to the end user if BARIL is not responsible.

BARIL will not cover the following situations:

- 1. Commercial use
- 2. Abuse of the product
- 3. Error in installation
- 4. Improper use

Instructions

Send to BARIL with:

- 1. Customer service call form
- 2. Customer's invoice

Email:
info@barildesign.com

Fax:
1.877.693.3005

.....
Please note this situation has been resolved on:

Date:

.....
By:

.....
Comment:

.....
.....
.....
.....
.....
.....
.....
.....
.....
.....

BARIL's technical team proposes you different examples.

When a customer enters your store, you must be ready to answer all questions on our faucets.

01 How long does the faucet warranty last?

The faucets have a lifetime warranty against all manufacturing defects. BARIL will replace free of charge any defective part upon presentation of the invoice of purchase showing the product code and the date of purchase. A manufacturing defect usually appears during the first few months of usage.

02 What is covered by the warranty?

Any defective part is covered by the warranty. BARIL will replace the faulty part free of charge. An original or similar replacement part will be sent to you. The warranty does not cover shipping and handling or labor fees. Warranty is void if the installation does not comply with the rules and regulations in effect or the manufacturer's instructions. The warranty does not cover damages that occurred during installation, transport or any other accidental or indirect damage.

03 What is the difference between manufacture defects from the normal use of a product?

The time of purchase is a determinant factor in diagnosing a defect. Our experience taught us that a manufacture defect occurs within a year of purchase in most products. Hand sprays, shower heads, finishes and all plastic parts show defects in the first 12 months of usage. As for diverter or seal, the defect can appear within 36

months of usage. The ceramic and thermostatic cartridges should be functional for a few years. Although, you should note that after 8 years of daily usage and hard water, etc., it is reasonable to consider it of normal use and it's possible for the customer to replace its cartridge. This can be done easily and at low costs. Finishes should last for many years if you use a gentle cleaning product. All parts not under warranty can be ordered at BARIL. They will be treated as a regular order and retail price will be applied.

04 How to order replacement parts?

You should have the original date of purchase and the product code. This information will help you find the code of the part you need as listed in our products file on our website; www.BARILdesign.com. You can also find the numerated parts in the instruction manual provided in the product packaging. Regarding discontinued products, or if you have questions, problems or any other requests, you can reach BARIL's customer service. They can help you find a part code or explain what is not working properly. Once you have the part code (or the date of purchase and product code), you can send your request by fax: 1.877.693.3005, by e-mail: info@barildesign.com, or by phone: 1.800.463.3871. The parts under warranty are free and the parts that are not under warranty will be charged which is why it is important to provide us the date of purchase along with your order.

05 How do I care for the faucets?

We recommend washing your faucets with warm water and a gentle, non-abrasive liquid soap. Wipe with a soft cotton cloth. Never use products that are abrasive, corrosive, or contain chemicals, powder cleaners or heavy-duty products such as tooth paste, detergents, scouring products, window cleaners and disinfectants. Cartridges can be cleaned with a small brush under running warm water. Limestone on hand spray can be removed by letting it soak in water with a drop of vinegar. As for the anti-limestone hand spray, you can use your fingers to wipe off excess sediment. Taking good care of your faucets will keep them working for many years.

06 Why is ceramic the best material to make cartridges?

Ceramic is strong, tear proof and able to adjust thus providing waterproofness. Ceramic discs are made to assure maximal pressure of your faucets. Their construction allows you to turn the water on and off with a 1/4 turn movement making it user friendly.

07 Do you offer after-sale services?

After more than 35 years in the faucet industry, BARIL is known for its expertise and the quality of its after-sale service. For any questions regarding our products, installation, various technical problems you may encounter during installation or if you have any requests regarding

the use of our products, our faucet professionals will be happy to help. The members of our customer service team are trained by our products experts and designers of the BARIL faucets. We also have a Quality department in charge of limiting as much as possible faucet related problems. From design to sales, the Quality department assures the liability of the BARIL products.

08 Can I install the faucets myself?

BARIL recommends you to hire a professional to install all our products. This will assure you the best installation possible. For instance, making sure a sufficient water flow reaches your faucet (depending on the floor level, the various appliances connected to the water line, etc.), making sure the connections are strong and waterproof, offering you a labor warranty on the installation, etc. In short, by hiring a professional, you will avoid all kinds of problems that could occur during installation and while using your faucets. Also, the installation will be made according to the norms in effect. An installation made according to the rules and regulations insures you the warranty will be honored, if ever needed.

09 Is there a system within these faucets for water saving?

BARIL is sensitive to the environment and offers many eco-friendly solutions. The majority of the BARIL lavatory and kitchen faucets offer the eco-friendly option of a 1.5 gpm flow instead of the usual 2.2 gpm, this means 30 % of water saving. Shower reducers are also available to gain even more efficiency and help gain the LEED certification.

10 Can I replace my faucets by new ones?

It is reasonable to think that all faucets are standard. It is usually possible to update your faucets with existing connections. Make sure to get new faucets that can fill the void left by the old ones. The installation of new faucets requires access to the rough and connections. You will find a variety of options in the complementary parts that will help you install new faucets on existing sinks, basins or bathtubs. You will find decorative plates, small columns for old fashioned bathtubs, etc. The majority of the BARIL products are made so the rough and the trim are installed at the same time. It is not necessary or possible to adapt the BARIL trim to the rough product of another manufacturer. If you change your mind and wish to choose a different trim offered in the BARIL collection, it is possible to interchange some collections due to the standard settings of the rough faucet. You can contact the customer service of BARIL, if needed.

What questions have we forgotten?

Send us your questions and we will add them in our next catalogue edition.

info@barildesign.com

Price Index

BARIL

PRICE INDEX

CODE	PAGE	PRIX
A04-1029-00-BB	294	296
A04-1029-00-CC	294	197
A04-1029-00-GG	294	433
A04-1029-00-KK	294	256
A04-1029-00-KM	294	394
A04-1029-00-LL	294	296
A04-1029-00-NN	294	256
A04-1029-00-TT	294	315
A04-1029-00-VV	294	315
A04-1029-00-YY	294	256
A04-1069-00-BB	294	138
A04-1069-00-CC	294	92
A04-1069-00-GG	294	202
A04-1069-00-KK	294	120
A04-1069-00-KM	294	184
A04-1069-00-LL	294	138
A04-1069-00-NN	294	120
A04-1069-00-TT	294	147
A04-1069-00-VV	294	147
A04-1069-00-YY	294	120
A04-6012-00-BB	294	368
A04-6012-00-CC	294	245
A04-6012-00-GG	294	539
A04-6012-00-KK	294	319
A04-6012-00-KM	294	490
A04-6012-00-LL	294	368
A04-6012-00-NN	294	319
A04-6012-00-TT	294	392
A04-6012-00-VV	294	392
A04-6012-00-YY	294	319
A04-6018-00-BB	294	413
A04-6018-00-CC	294	275
A04-6018-00-GG	294	605
A04-6018-00-KK	294	358
A04-6018-00-KM	294	550
A04-6018-00-LL	294	413
A04-6018-00-NN	294	358
A04-6018-00-TT	294	440
A04-6018-00-VV	294	440
A04-6018-00-YY	294	358
A04-6024-00-BB	294	458
A04-6024-00-CC	294	305
A04-6024-00-GG	294	671
A04-6024-00-KK	294	397
A04-6024-00-KM	294	610
A04-6024-00-LL	294	458
A04-6024-00-NN	294	397
A04-6024-00-TT	294	488
A04-6024-00-VV	294	488
A04-6024-00-YY	294	397
A04-6030-00-BB	295	578
A04-6030-00-CC	295	385
A04-6030-00-GG	295	847
A04-6030-00-KK	295	501
A04-6030-00-KM	295	770
A04-6030-00-LL	295	578
A04-6030-00-NN	295	501
A04-6030-00-TT	295	616

CODE	PAGE	PRIX
A04-6030-00-VV	295	616
A04-6030-00-YY	295	501
A44-1029-00-BB	296	216
A44-1029-00-CC	296	144
A44-1029-00-GG	296	317
A44-1029-00-KK	296	187
A44-1029-00-LL	296	216
A44-1029-00-NN	296	187
A44-1029-00-TT	296	230
A44-1029-00-VV	296	230
A44-1029-00-YY	296	187
A44-1069-00-BB	296	135
A44-1069-00-CC	296	90
A44-1069-00-GG	296	198
A44-1069-00-KK	296	117
A44-1069-00-LL	296	135
A44-1069-00-NN	296	117
A44-1069-00-TT	296	144
A44-1069-00-VV	296	144
A44-1069-00-YY	296	117
A44-6017-00-BB	296	372
A44-6017-00-CC	296	248
A44-6017-00-GG	296	546
A44-6017-00-KK	296	323
A44-6017-00-LL	296	372
A44-6017-00-NN	296	323
A44-6017-00-TT	296	397
A44-6017-00-VV	296	397
A44-6017-00-YY	296	323
A44-6027-00-BB	296	447
A44-6027-00-CC	296	298
A44-6027-00-GG	296	656
A44-6027-00-KK	296	387
A44-6027-00-LL	296	447
A44-6027-00-NN	296	387
A44-6027-00-TT	296	477
A44-6027-00-VV	296	477
A44-6027-00-YY	296	387
A46-1029-00-BB	297	339
A46-1029-00-CC	297	226
A46-1029-00-CF	297	226
A46-1029-00-GG	297	497
A46-1029-00-KK	297	294
A46-1029-00-LL	297	339
A46-1029-00-NN	297	294
A46-1029-00-TT	297	361
A46-1029-00-VV	297	361
A46-1029-00-YY	297	294
A46-1069-00-BB	297	189
A46-1069-00-CC	297	126
A46-1069-00-CF	297	126
A46-1069-00-GG	297	277
A46-1069-00-KK	297	164
A46-1069-00-LL	297	189
A46-1069-00-NN	297	164
A46-1069-00-TT	297	202
A46-1069-00-VV	297	202
A46-1069-00-YY	297	164

CODE	PAGE	PRIX
A46-6012-00-BB	297	438
A46-6012-00-CC	297	292
A46-6012-00-CF	297	292
A46-6012-00-GG	297	642
A46-6012-00-KK	297	380
A46-6012-00-LL	297	438
A46-6012-00-NN	297	380
A46-6012-00-TT	297	467
A46-6012-00-VV	297	467
A46-6012-00-YY	297	380
A46-6018-00-BB	297	483
A46-6018-00-CC	297	322
A46-6018-00-CF	297	322
A46-6018-00-GG	297	708
A46-6018-00-KK	297	419
A46-6018-00-LL	297	483
A46-6018-00-NN	297	419
A46-6018-00-TT	297	515
A46-6018-00-VV	297	515
A46-6018-00-YY	297	419
A46-6024-00-BB	297	546
A46-6024-00-CC	297	364
A46-6024-00-CF	297	364
A46-6024-00-GG	297	800
A46-6024-00-KK	297	473
A46-6024-00-LL	297	546
A46-6024-00-NN	297	473
A46-6024-00-TT	297	582
A46-6024-00-VV	297	582
A46-6024-00-YY	297	473
A46-6030-00-BB	298	658
A46-6030-00-CC	298	439
A46-6030-00-CF	298	439
A46-6030-00-GG	298	965
A46-6030-00-KK	298	570
A46-6030-00-LL	298	658
A46-6030-00-NN	298	570
A46-6030-00-TT	298	702
A46-6030-00-VV	298	702
A46-6030-00-YY	298	570
A47-1069-00-Bx	298	329
A47-1069-00-Cx	298	219
A47-1069-00-Gx	298	482
A47-1069-00-Kx	298	285
A47-1069-00-Lx	298	329
A47-1069-00-Nx	298	285
A47-1069-00-Tx	298	350
A47-1069-00-Vx	298	350
A47-1069-00-Yx	298	285
A56-1029-00-BB	299	339
A56-1029-00-CC	299	226
A56-1029-00-GG	299	497
A56-1029-00-KK	299	294
A56-1029-00-LL	299	339
A56-1029-00-NN	299	294
A56-1029-00-TT	299	361
A56-1029-00-VV	299	361
A56-1029-00-YY	299	294

Actual products may differ from pictures. Actual products measures may differ from the measures shown. All USD prices are subject to change without notice. Effective as of August 2023.

PRICE INDEX

CODE	PAGE	PRICE
A56-1069-00-BB	299	174
A56-1069-00-CC	299	116
A56-1069-00-GG	299	255
A56-1069-00-KK	299	151
A56-1069-00-LL	299	174
A56-1069-00-NN	299	151
A56-1069-00-TT	299	186
A56-1069-00-VV	299	186
A56-1069-00-YY	299	151
A56-6018-00-BB	299	438
A56-6018-00-CC	299	292
A56-6018-00-GG	299	642
A56-6018-00-KK	299	380
A56-6018-00-LL	299	438
A56-6018-00-NN	299	380
A56-6018-00-TT	299	467
A56-6018-00-VV	299	467
A56-6018-00-YY	299	380
A56-6024-00-BB	299	510
A56-6024-00-CC	299	340
A56-6024-00-GG	299	748
A56-6024-00-KK	299	442
A56-6024-00-LL	299	510
A56-6024-00-NN	299	442
A56-6024-00-TT	299	544
A56-6024-00-VV	299	544
A56-6024-00-YY	299	442
A56-6028-00-BB	299	615
A56-6028-00-CC	299	410
A56-6028-00-GG	299	902
A56-6028-00-KK	299	533
A56-6028-00-LL	299	615
A56-6028-00-NN	299	533
A56-6028-00-TT	299	656
A56-6028-00-VV	299	656
A56-6028-00-YY	299	533
A66-1029-01-BB	300	296
A66-1029-01-CC	300	197
A66-1029-01-GG	300	433
A66-1029-01-KK	300	256
A66-1029-01-LL	300	296
A66-1029-01-NN	300	256
A66-1029-01-TT	300	315
A66-1029-01-VV	300	315
A66-1029-01-YY	300	256
A66-1069-01-BB	300	149
A66-1069-01-CC	300	99
A66-1069-01-GG	300	218
A66-1069-01-KK	300	129
A66-1069-01-LL	300	149
A66-1069-01-NN	300	129
A66-1069-01-TT	300	158
A66-1069-01-VV	300	158
A66-1069-01-YY	300	129
A66-1079-00-BB	300	119
A66-1079-00-CC	300	79
A66-1079-00-GG	300	174
A66-1079-00-KK	300	103

CODE	PAGE	PRICE
A66-1079-00-LL	300	119
A66-1079-00-NN	300	103
A66-1079-00-TT	300	126
A66-1079-00-VV	300	126
A66-1079-00-YY	300	103
A66-6018-00-BB	300	449
A66-6018-00-CC	300	299
A66-6018-00-GG	300	658
A66-6018-00-KK	300	389
A66-6018-00-LL	300	449
A66-6018-00-NN	300	389
A66-6018-00-TT	300	478
A66-6018-00-VV	300	478
A66-6018-00-YY	300	389
A66-6024-00-BB	300	485
A66-6024-00-CC	300	323
A66-6024-00-GG	300	711
A66-6024-00-KK	300	420
A66-6024-00-LL	300	485
A66-6024-00-NN	300	420
A66-6024-00-TT	300	517
A66-6024-00-VV	300	517
A66-6024-00-YY	300	420
A66-6030-00-BB	301	571
A66-6030-00-CC	301	381
A66-6030-00-GG	301	838
A66-6030-00-KK	301	495
A66-6030-00-LL	301	571
A66-6030-00-NN	301	495
A66-6030-00-TT	301	609
A66-6030-00-VV	301	609
A66-6030-00-YY	301	495
A66-6315-00-BB	301	599
A66-6315-00-CC	301	399
A66-6315-00-GG	301	878
A66-6315-00-KK	301	519
A66-6315-00-LL	301	599
A66-6315-00-NN	301	519
A66-6315-00-TT	301	638
A66-6315-00-VV	301	638
A66-6315-00-YY	301	519
A80-1069-00-Bx	292	338
A80-1069-00-Cx	292	225
A80-1069-00-Gx	292	495
A80-1069-00-Kx	292	293
A80-1069-00-Lx	292	338
A80-1069-00-Nx	292	293
A80-1069-00-Tx	292	360
A80-1069-00-Vx	292	360
A80-1069-00-Yx	292	293
A84-1069-00-BB	302	198
A84-1069-00-CC	302	132
A84-1069-00-GG	302	290
A84-1069-00-KK	302	172
A84-1069-00-LL	302	198
A84-1069-00-NN	302	172
A84-1069-00-TT	302	211
A84-1069-00-VV	302	211

CODE	PAGE	PRICE
A84-1069-00-YY	302	172
A85-2009-40-CC	303	523
A85-2059-00-CC	303	248
A85-2059-40-CC	303	298
A85-3179-00-CC	303	173
A85-3189-00-CC	303	118
A85-9000-00-CC	304	564
A85-9019-00-CC	304	121
A85-9077-00-CC	304	248
A85-9088-00-CC	304	298
A86-2019-00-FR	305	58
A86-2029-00-FR	305	58
A86-2039-00-CC	305	118
A86-6018-00-BB	305	747
A86-6018-00-CC	305	498
A86-6018-00-GG	305	1096
A86-6018-00-KK	305	647
A86-6018-00-LL	305	747
A86-6018-00-NN	305	647
A86-6018-00-TT	305	797
A86-6018-00-VV	305	797
A86-6018-00-YY	305	647
B04-1005-00L-BB	70	693
B04-1005-00L-CC	70	462
B04-1005-00L-GG	70	1011
B04-1005-00L-KK	70	600
B04-1005-00L-KM	70	739
B04-1005-00L-LL	70	693
B04-1005-00L-NN	70	600
B04-1005-00L-TT	70	739
B04-1005-00L-VV	70	739
B04-1005-00L-YY	70	600
B04-1005-1PL-BB	70	765
B04-1005-1PL-CC	70	510
B04-1005-1PL-GG	70	1122
B04-1005-1PL-KK	70	663
B04-1005-1PL-KM	70	816
B04-1005-1PL-LL	70	765
B04-1005-1PL-NN	70	663
B04-1005-1PL-TT	70	816
B04-1005-1PL-VV	70	816
B04-1005-1PL-YY	70	663
B04-1020-00L-BB	70	1135
B04-1020-00L-CC	70	756
B04-1020-00L-GG	70	1664
B04-1020-00L-KK	70	983
B04-1020-00L-KM	70	1210
B04-1020-00L-LL	70	1135
B04-1020-00L-NN	70	983
B04-1020-00L-TT	70	1210
B04-1020-00L-VV	70	1210
B04-1020-00L-YY	70	983
B04-1100-00-BB	72	3423
B04-1100-00-CC	72	2282
B04-1100-00-GG	72	5021
B04-1100-00-KK	72	2739
B04-1100-00-KM	72	3652
B04-1100-00-LL	72	3423

Finishes:

CC = chrome, CD = chrome diamond, CF = smokey chrome, KK = matte black, LL = satin brass, BB = white, NN = brushed nickel, YY = polished nickel, TT = venetian bronze, VV = satin copper, GG = gold, KM = black titanium, CB = chrome white, KB = matte black white, LB = satin brass white, NB = brushed nickel white, YB = polished nickel white, TB = venetian bronze, VB = satin copper white, GB = gold white

PRICE INDEX

CODE	PAGE	PRICE
B04-1100-00-NN	72	2967
B04-1100-00-TT	72	3652
B04-1100-00-VV	72	3652
B04-1100-00-YY	72	2967
B04-1249-00-BB	72	1725
B04-1249-00-CC	72	1150
B04-1249-00-GG	72	2531
B04-1249-00-KK	72	1495
B04-1249-00-KM	72	1840
B04-1249-00-LL	72	1725
B04-1249-00-NN	72	1495
B04-1249-00-TT	72	1840
B04-1249-00-VV	72	1840
B04-1249-00-YY	72	1495
B04-8009-00L-BB	70	1276
B04-8009-00L-CC	70	851
B04-8009-00L-GG	70	1871
B04-8009-00L-KK	70	1106
B04-8009-00L-KM	70	1361
B04-8009-00L-LL	70	1276
B04-8009-00L-NN	70	1106
B04-8009-00L-TT	70	1361
B04-8009-00L-VV	70	1361
B04-8009-00L-YY	70	1106
B04-8100-00L-BB	71	1221
B04-8100-00L-CC	71	814
B04-8100-00L-GG	71	1791
B04-8100-00L-KK	71	977
B04-8100-00L-KM	71	1302
B04-8100-00L-LL	71	1221
B04-8100-00L-NN	71	977
B04-8100-00L-TT	71	1302
B04-8100-00L-VV	71	1302
B04-8100-00L-YY	71	1058
B04-8120-00L-BB	71	1425
B04-8120-00L-CC	71	950
B04-8120-00L-GG	71	2090
B04-8120-00L-KK	71	1235
B04-8120-00L-KM	71	1520
B04-8120-00L-LL	71	1425
B04-8120-00L-NN	71	1235
B04-8120-00L-TT	71	1520
B04-8120-00L-VV	71	1520
B04-8120-00L-YY	71	1235
B04-9100-00-BB	72	813
B04-9100-00-CC	72	645
B04-9100-00-GG	72	1047
B04-9100-00-KK	72	746
B04-9100-00-LL	72	813
B04-9100-00-NN	72	746
B04-9100-00-TT	72	846
B04-9100-00-VV	72	846
B04-9100-00-YY	72	746
B04-9180-00-BB	73	1025
B04-9180-00-CC	73	841
B04-9180-00-GG	73	1281
B04-9180-00-KK	73	951
B04-9180-00-KM	73	1061

CODE	PAGE	PRICE
B04-9180-00-LL	73	1025
B04-9180-00-NN	73	951
B04-9180-00-TT	73	1061
B04-9180-00-VV	73	1061
B04-9180-00-YY	73	951
B04-9190-00-BB	73	1080
B04-9190-00-CC	73	896
B04-9190-00-GG	73	1336
B04-9190-00-KK	73	1006
B04-9190-00-LL	73	1080
B04-9190-00-NN	73	1006
B04-9190-00-TT	73	1116
B04-9190-00-VV	73	1116
B04-9190-00-YY	73	1006
B04-9404-00-BB	74	1458
B04-9404-00-CC	74	1199
B04-9404-00-GG	74	1819
B04-9404-00-KK	74	1354
B04-9404-00-LL	74	1458
B04-9404-00-NN	74	1354
B04-9404-00-TT	74	1509
B04-9404-00-VV	74	1509
B04-9404-00-YY	74	1354
B04-9453-00-BB	74	1425
B04-9453-00-CC	74	1166
B04-9453-00-GG	74	1786
B04-9453-00-KK	74	1321
B04-9453-00-LL	74	1425
B04-9453-00-NN	74	1321
B04-9453-00-TT	74	1476
B04-9453-00-VV	74	1476
B04-9453-00-YY	74	1321
B04-9521-00-BB	74	1335
B04-9521-00-CC	74	1118
B04-9521-00-GG	74	1638
B04-9521-00-KK	74	1248
B04-9521-00-KM	74	1378
B04-9521-00-LL	74	1335
B04-9521-00-NN	74	1248
B04-9521-00-TT	74	1378
B04-9521-00-VV	74	1378
B04-9521-00-YY	74	1248
B04-9531-00-BB	75	1445
B04-9531-00-CC	75	1228
B04-9531-00-GG	75	1748
B04-9531-00-KK	75	1358
B04-9531-00-KM	75	1488
B04-9531-00-LL	75	1445
B04-9531-00-NN	75	1358
B04-9531-00-TT	75	1488
B04-9531-00-VV	75	1488
B04-9531-00-YY	75	1358
B04-9560-02-BB	75	620
B04-9560-02-CC	75	513
B04-9560-02-GG	75	770
B04-9560-02-KK	75	577
B04-9560-02-LL	75	620
B04-9560-02-NN	75	577

CODE	PAGE	PRICE
B04-9560-02-TT	75	641
B04-9560-02-VV	75	641
B04-9560-02-YY	75	577
B04-9560-03-BB	76	702
B04-9560-03-CC	76	595
B04-9560-03-GG	76	852
B04-9560-03-KK	76	659
B04-9560-03-LL	76	702
B04-9560-03-NN	76	659
B04-9560-03-TT	76	723
B04-9560-03-VV	76	723
B04-9560-03-YY	76	659
B04-9649-00-BB	76	556
B04-9649-00-CC	76	449
B04-9649-00-GG	76	706
B04-9649-00-KK	76	513
B04-9649-00-LL	76	556
B04-9649-00-NN	76	513
B04-9649-00-TT	76	577
B04-9649-00-VV	76	577
B04-9649-00-YY	76	513
B05-1005-00L-BB	88	880
B05-1005-00L-CC	88	587
B05-1005-00L-GG	88	1285
B05-1005-00L-KK	88	762
B05-1005-00L-LL	88	880
B05-1005-00L-NN	88	762
B05-1005-00L-TT	88	938
B05-1005-00L-VV	88	938
B05-1005-00L-YY	88	762
B05-1005-1PL-BB	88	952
B05-1005-1PL-CC	88	635
B05-1005-1PL-GG	88	1396
B05-1005-1PL-KK	88	825
B05-1005-1PL-LL	88	952
B05-1005-1PL-NN	88	825
B05-1005-1PL-TT	88	1015
B05-1005-1PL-VV	88	1015
B05-1005-1PL-YY	88	825
B05-1010-01L-BB	88	941
B05-1010-01L-CC	88	627
B05-1010-01L-GG	88	1374
B05-1010-01L-KK	88	815
B05-1010-01L-LL	88	941
B05-1010-01L-NN	88	815
B05-1010-01L-TT	88	1003
B05-1010-01L-VV	88	1003
B05-1010-01L-YY	88	815
B05-1010-1PL-BB	88	1013
B05-1010-1PL-CC	88	675
B05-1010-1PL-GG	88	1485
B05-1010-1PL-KK	88	878
B05-1010-1PL-LL	88	1013
B05-1010-1PL-NN	88	878
B05-1010-1PL-TT	88	1080
B05-1010-1PL-VV	88	1080
B05-1010-1PL-YY	88	878
B05-1015-01L-CC	88	686

Actual products may differ from pictures. Actual products measures may differ from the measures shown. All USD prices are subject to change without notice. Effective as of August 2023.

PRICE INDEX

CODE	PAGE	PRICE
B05-1015-1PL-CC	88	734
B05-1020-00L-BB	88	1239
B05-1020-00L-CC	88	826
B05-1020-00L-GG	88	1817
B05-1020-00L-KK	88	1074
B05-1020-00L-LL	88	1239
B05-1020-00L-NN	88	1074
B05-1020-00L-TT	88	1322
B05-1020-00L-VV	88	1322
B05-1020-00L-YY	88	1074
B05-1100-02-BB	89	3593
B05-1100-02-CC	89	2395
B05-1100-02-GG	89	5269
B05-1100-02-KK	89	3114
B05-1100-02-LL	89	3593
B05-1100-02-NN	89	3114
B05-1100-02-TT	89	3832
B05-1100-02-VV	89	3832
B05-1100-02-YY	89	3114
B05-1269-00-BB	90	1812
B05-1269-00-CC	90	1208
B05-1269-00-GG	90	2658
B05-1269-00-KK	90	1570
B05-1269-00-LL	90	1812
B05-1269-00-NN	90	1570
B05-1269-00-TT	90	1933
B05-1269-00-VV	90	1933
B05-1269-00-YY	90	1570
B05-1331-07-BB	90	2001
B05-1331-07-CC	90	1334
B05-1331-07-GG	90	2935
B05-1331-07-KK	90	1735
B05-1331-07-LL	90	2001
B05-1331-07-NN	90	1735
B05-1331-07-TT	90	2135
B05-1331-07-VV	90	2135
B05-1331-07-YY	90	1735
B05-1600-00-BB	90	1690
B05-1600-00-CC	90	1127
B05-1600-00-GG	90	2479
B05-1600-00-KK	90	1465
B05-1600-00-LL	90	1690
B05-1600-00-NN	90	1465
B05-1600-00-TT	90	1803
B05-1600-00-VV	90	1803
B05-1600-00-YY	90	1465
B05-2001-00-BB	91	3176
B05-2001-00-CC	91	2118
B05-2001-00-GG	91	4659
B05-2001-00-KK	91	2753
B05-2001-00-LL	91	3176
B05-2001-00-NN	91	2753
B05-2001-00-TT	91	3388
B05-2001-00-VV	91	3388
B05-2001-00-YY	91	2753
B05-8009-00L-BB	89	1586
B05-8009-00L-CC	89	1057
B05-8009-00L-GG	89	2326

CODE	PAGE	PRICE
B05-8009-00L-KK	89	1374
B05-8009-00L-LL	89	1586
B05-8009-00L-NN	89	1374
B05-8009-00L-TT	89	1691
B05-8009-00L-VV	89	1691
B05-8009-00L-YY	89	1374
B05-8100-00L-BB	89	1369
B05-8100-00L-CC	89	913
B05-8100-00L-GG	89	2008
B05-8100-00L-KK	89	1187
B05-8100-00L-LL	89	1369
B05-8100-00L-NN	89	1187
B05-8100-00L-TT	89	1460
B05-8100-00L-VV	89	1460
B05-8100-00L-YY	89	1187
B05-9100-00-BB	91	835
B05-9100-00-CC	91	660
B05-9100-00-GG	91	1080
B05-9100-00-KK	91	765
B05-9100-00-LL	91	835
B05-9100-00-NN	91	765
B05-9100-00-TT	91	870
B05-9100-00-VV	91	870
B05-9100-00-YY	91	765
B05-9181-00-BB	91	1139
B05-9181-00-CC	91	917
B05-9181-00-GG	91	1449
B05-9181-00-KK	91	1050
B05-9181-00-LL	91	1139
B05-9181-00-NN	91	1050
B05-9181-00-TT	91	1183
B05-9181-00-VV	91	1183
B05-9181-00-YY	91	1050
B05-9404-00-BB	92	1523
B05-9404-00-CC	92	1243
B05-9404-00-GG	92	1915
B05-9404-00-KK	92	1411
B05-9404-00-LL	92	1523
B05-9404-00-NN	92	1411
B05-9404-00-TT	92	1579
B05-9404-00-VV	92	1579
B05-9404-00-YY	92	1411
B05-9521-00-BB	92	1387
B05-9521-00-CC	92	1153
B05-9521-00-GG	92	1715
B05-9521-00-KK	92	1293
B05-9521-00-LL	92	1387
B05-9521-00-NN	92	1293
B05-9521-00-TT	92	1434
B05-9521-00-VV	92	1434
B05-9521-00-YY	92	1293
B05-9531-00-BB	93	1497
B05-9531-00-CC	93	1263
B05-9531-00-GG	93	1825
B05-9531-00-KK	93	1403
B05-9531-00-LL	93	1497
B05-9531-00-NN	93	1403
B05-9531-00-TT	93	1544

CODE	PAGE	PRICE
B05-9531-00-VV	93	1544
B05-9531-00-YY	93	1403
B05-9560-02-BB	93	665
B05-9560-02-CC	93	543
B05-9560-02-GG	93	836
B05-9560-02-KK	93	616
B05-9560-02-LL	93	665
B05-9560-02-NN	93	616
B05-9560-02-TT	93	689
B05-9560-02-VV	93	689
B05-9560-02-YY	93	616
B05-9560-03-BB	94	747
B05-9560-03-CC	94	625
B05-9560-03-GG	94	918
B05-9560-03-KK	94	698
B05-9560-03-LL	94	747
B05-9560-03-NN	94	698
B05-9560-03-TT	94	771
B05-9560-03-VV	94	771
B05-9560-03-YY	94	698
B05-9600-00-BB	94	540
B05-9600-00-CC	94	418
B05-9600-00-GG	94	711
B05-9600-00-KK	94	491
B05-9600-00-LL	94	540
B05-9600-00-NN	94	491
B05-9600-00-TT	94	564
B05-9600-00-VV	94	564
B05-9600-00-YY	94	491
B05-9649-00-BB	94	601
B05-9649-00-CC	94	479
B05-9649-00-GG	94	772
B05-9649-00-KK	94	552
B05-9649-00-LL	94	601
B05-9649-00-NN	94	552
B05-9649-00-TT	94	625
B05-9649-00-VV	94	625
B05-9649-00-YY	94	552
B14-1010-01L-BB	104	933
B14-1010-01L-CC	104	622
B14-1010-01L-GG	104	1363
B14-1010-01L-KK	104	808
B14-1010-01L-LL	104	933
B14-1010-01L-NN	104	808
B14-1010-01L-TT	104	995
B14-1010-01L-VV	104	995
B14-1010-01L-YY	104	808
B14-1010-1PL-BB	104	1005
B14-1010-1PL-CC	104	670
B14-1010-1PL-GG	104	1474
B14-1010-1PL-KK	104	871
B14-1010-1PL-LL	104	1005
B14-1010-1PL-NN	104	871
B14-1010-1PL-TT	104	1072
B14-1010-1PL-VV	104	1072
B14-1010-1PL-YY	104	871
B14-1020-00L-BB	104	1101
B14-1020-00L-CC	104	734

Finishes:

CC = chrome, CD = chrome diamond, CF = smokey chrome, KK = matte black, LL = satin brass, BB = white, NN = brushed nickel, YY = polished nickel, TT = venetian bronze, VV = satin copper, GG = gold, KM = black titanium, CB = chrome white, KB = matte black white, LB = satin brass white, NB = brushed nickel white, YB = polished nickel white, TB = venetian bronze, VB = satin copper white, GB = gold white

PRICE INDEX

CODE	PAGE	PRICE
B18-9560-02-BB	112	730
B18-9560-02-CB	112	586
B18-9560-02-CC	112	586
B18-9560-02-GB	112	930
B18-9560-02-GG	112	930
B18-9560-02-KB	112	672
B18-9560-02-KK	112	672
B18-9560-02-LB	112	730
B18-9560-02-LL	112	730
B18-9560-02-NB	112	672
B18-9560-02-NN	112	672
B18-9560-02-TB	112	758
B18-9560-02-TT	112	758
B18-9560-02-VB	112	758
B18-9560-02-VV	112	758
B18-9560-02-YB	112	672
B18-9560-02-YY	112	672
B18-9560-03-BB	112	812
B18-9560-03-CB	112	668
B18-9560-03-CC	112	668
B18-9560-03-GB	112	1012
B18-9560-03-GG	112	1012
B18-9560-03-KB	112	754
B18-9560-03-KK	112	754
B18-9560-03-LB	112	812
B18-9560-03-LL	112	812
B18-9560-03-NB	112	754
B18-9560-03-NN	112	754
B18-9560-03-TB	112	840
B18-9560-03-TT	112	840
B18-9560-03-VB	112	840
B18-9560-03-VV	112	840
B18-9560-03-YB	112	754
B18-9560-03-YY	112	754
B18-9601-00-BB	113	605
B18-9601-00-CB	113	461
B18-9601-00-CC	113	461
B18-9601-00-GB	113	805
B18-9601-00-GG	113	805
B18-9601-00-KB	113	547
B18-9601-00-KK	113	547
B18-9601-00-LB	113	605
B18-9601-00-LL	113	605
B18-9601-00-NB	113	547
B18-9601-00-NN	113	547
B18-9601-00-TB	113	633
B18-9601-00-TT	113	633
B18-9601-00-VB	113	633
B18-9601-00-VV	113	633
B18-9601-00-YB	113	547
B18-9601-00-YY	113	547
B18-9641-00-BB	113	666
B18-9641-00-CB	113	522
B18-9641-00-CC	113	522
B18-9641-00-GB	113	866
B18-9641-00-GG	113	866
B18-9641-00-KB	113	608
B18-9641-00-KK	113	608

CODE	PAGE	PRICE
B18-9641-00-LB	113	666
B18-9641-00-LL	113	666
B18-9641-00-NB	113	608
B18-9641-00-NN	113	608
B18-9641-00-TB	113	694
B18-9641-00-TT	113	694
B18-9641-00-VB	113	694
B18-9641-00-VV	113	694
B18-9641-00-YB	113	608
B18-9641-00-YY	113	608
B26-1481-07-CD	118	2078
B26-8000-00L-CD	118	1298
B26-9404-00-CD	119	1681
B26-9560-02-CD	119	723
B26-9560-03-CD	120	805
B26-9600-00-CD	120	598
B26-9640-00-CD	121	659
B27-1481-07-BB	118	2279
B27-1481-07-CC	118	1519
B27-1481-07-GG	118	3343
B27-1481-07-KK	118	1975
B27-1481-07-LL	118	2279
B27-1481-07-NN	118	1975
B27-1481-07-TT	118	2431
B27-1481-07-VV	118	2431
B27-1481-07-YY	118	1975
B27-8000-00L-BB	118	1611
B27-8000-00L-CC	118	1074
B27-8000-00L-GG	118	2363
B27-8000-00L-KK	118	1397
B27-8000-00L-LL	118	1611
B27-8000-00L-NN	118	1397
B27-8000-00L-TT	118	1719
B27-8000-00L-VV	118	1719
B27-8000-00L-YY	118	1397
B27-9404-00-BB	119	1714
B27-9404-00-CC	119	1370
B27-9404-00-GG	119	2196
B27-9404-00-KK	119	1576
B27-9404-00-LL	119	1714
B27-9404-00-NN	119	1576
B27-9404-00-TT	119	1783
B27-9404-00-VV	119	1783
B27-9404-00-YY	119	1576
B27-9560-02-BB	119	730
B27-9560-02-CC	119	586
B27-9560-02-GG	119	930
B27-9560-02-KK	119	672
B27-9560-02-LL	119	730
B27-9560-02-NN	119	672
B27-9560-02-TT	119	758
B27-9560-02-VV	119	758
B27-9560-02-YY	119	672
B27-9560-03-BB	120	812
B27-9560-03-CC	120	668
B27-9560-03-GG	120	1012
B27-9560-03-KK	120	754
B27-9560-03-LL	120	812

CODE	PAGE	PRICE
B27-9560-03-NN	120	754
B27-9560-03-TT	120	840
B27-9560-03-VV	120	840
B27-9560-03-YY	120	754
B27-9600-00-BB	120	605
B27-9600-00-CC	120	461
B27-9600-00-GG	120	805
B27-9600-00-KK	120	547
B27-9600-00-LL	120	605
B27-9600-00-NN	120	547
B27-9600-00-TT	120	633
B27-9600-00-VV	120	633
B27-9600-00-YY	120	547
B27-9640-00-BB	121	666
B27-9640-00-CC	121	522
B27-9640-00-GG	121	866
B27-9640-00-KK	121	608
B27-9640-00-LL	121	666
B27-9640-00-NN	121	608
B27-9640-00-TT	121	694
B27-9640-00-VV	121	694
B27-9640-00-YY	121	608
B28-1481-07-BB	118	2279
B28-1481-07-CC	118	1519
B28-1481-07-GG	118	3343
B28-1481-07-KK	118	1975
B28-1481-07-LL	118	2279
B28-1481-07-NN	118	1975
B28-1481-07-TT	118	2431
B28-1481-07-VV	118	2431
B28-1481-07-YY	118	1975
B28-8000-00L-BB	118	1611
B28-8000-00L-CC	118	1074
B28-8000-00L-GG	118	2363
B28-8000-00L-KK	118	1397
B28-8000-00L-LL	118	1611
B28-8000-00L-NN	118	1397
B28-8000-00L-TT	118	1719
B28-8000-00L-VV	118	1719
B28-8000-00L-YY	118	1397
B28-9404-00-BB	119	1714
B28-9404-00-CC	119	1370
B28-9404-00-GG	119	2196
B28-9404-00-KK	119	1576
B28-9404-00-LL	119	1714
B28-9404-00-NN	119	1576
B28-9404-00-TT	119	1783
B28-9404-00-VV	119	1783
B28-9404-00-YY	119	1576
B28-9560-02-BB	119	730
B28-9560-02-CC	119	586
B28-9560-02-GG	119	930
B28-9560-02-KK	119	672
B28-9560-02-LL	119	730
B28-9560-02-NN	119	672
B28-9560-02-TT	119	758
B28-9560-02-VV	119	758
B28-9560-02-YY	119	672

Finishes:

CC = chrome, CD = chrome diamond, CF = smokey chrome, KK = matte black, LL = satin brass, BB = white, NN = brushed nickel, YY = polished nickel, TT = venetian bronze, VV = satin copper, GG = gold, KM = black titanium, CB = chrome white, KB = matte black white, LB = satin brass white, NB = brushed nickel white, YB = polished nickel white, TB = venetian bronze, VB = satin copper white, GB = gold white

PRICE INDEX

CODE	PAGE	PRICE
B28-9560-03-BB	120	812
B28-9560-03-CC	120	668
B28-9560-03-GG	120	1012
B28-9560-03-KK	120	754
B28-9560-03-LL	120	812
B28-9560-03-NN	120	754
B28-9560-03-TT	120	840
B28-9560-03-VV	120	840
B28-9560-03-YY	120	754
B28-9600-00-BB	120	605
B28-9600-00-CC	120	461
B28-9600-00-GG	120	805
B28-9600-00-KK	120	547
B28-9600-00-LL	120	605
B28-9600-00-NN	120	547
B28-9600-00-TT	120	633
B28-9600-00-VV	120	633
B28-9600-00-YY	120	547
B28-9640-00-BB	121	666
B28-9640-00-CC	121	522
B28-9640-00-GG	121	866
B28-9640-00-KK	121	608
B28-9640-00-LL	121	666
B28-9640-00-NN	121	608
B28-9640-00-TT	121	694
B28-9640-00-VV	121	694
B28-9640-00-YY	121	608
B35-1020-00L-CKE	128	1297
B35-1020-00L-CKI	128	1297
B35-1020-00L-CKJ	128	1297
B35-1020-00L-CKK	128	1297
B35-1020-00L-IKE	128	1514
B35-1020-00L-IKI	128	1514
B35-1020-00L-IKJ	128	1514
B35-1020-00L-IKK	128	1514
B35-1020-00L-JKE	128	1514
B35-1020-00L-JKI	128	1514
B35-1020-00L-JKJ	128	1514
B35-1020-00L-JKK	128	1514
B35-1020-00L-KKE	128	1514
B35-1020-00L-KKI	128	1514
B35-1020-00L-KKJ	128	1514
B35-1020-00L-KKK	128	1514
B35-1100-00-KE	130	1545
B35-8009-00L-Cxxx	129	1405
B35-8009-00L-xxxx	129	1622
B35-8100-00L-Cxxx	129	1405
B35-8100-00L-xxxx	129	1622
B35-9320-00-III	131	4335
B35-9320-00-IIK	131	4335
B35-9320-00-IJI	131	4335
B35-9320-00-IJK	131	4335
B35-9320-00-IKI	131	4335
B35-9320-00-IKK	131	4335
B35-9320-00-KII	131	4335
B35-9320-00-KIK	131	4335
B35-9320-00-KJI	131	4335
B35-9320-00-KJK	131	4335

CODE	PAGE	PRICE
B35-9320-00-KKI	131	4335
B35-9320-00-KKK	131	4335
B35-9521-00-CI	131	1731
B35-9521-00-CJ	131	1731
B35-9521-00-CK	131	1731
B35-9521-00-II	131	1948
B35-9521-00-IJ	131	1948
B35-9521-00-IK	131	1948
B35-9521-00-KI	131	1948
B35-9521-00-KJ	131	1948
B35-9521-00-KK	131	1948
B45-1005-00L-BB	136	743
B45-1005-00L-CC	136	496
B45-1005-00L-GG	136	1085
B45-1005-00L-KK	136	644
B45-1005-00L-LL	136	743
B45-1005-00L-NN	136	644
B45-1005-00L-TT	136	793
B45-1005-00L-VV	136	793
B45-1005-00L-YY	136	644
B45-1005-IPL-BB	136	815
B45-1005-IPL-CC	136	544
B45-1005-IPL-GG	136	1196
B45-1005-IPL-KK	136	707
B45-1005-IPL-LL	136	815
B45-1005-IPL-NN	136	707
B45-1005-IPL-TT	136	870
B45-1005-IPL-VV	136	870
B45-1005-IPL-YY	136	707
B45-1010-00L-BB	136	795
B45-1010-00L-CC	136	530
B45-1010-00L-GG	136	1160
B45-1010-00L-KK	136	688
B45-1010-00L-LL	136	795
B45-1010-00L-NN	136	688
B45-1010-00L-TT	136	847
B45-1010-00L-VV	136	847
B45-1010-00L-YY	136	688
B45-1010-IPL-BB	136	867
B45-1010-IPL-CC	136	578
B45-1010-IPL-GG	136	1271
B45-1010-IPL-KK	136	751
B45-1010-IPL-LL	136	867
B45-1010-IPL-NN	136	751
B45-1010-IPL-TT	136	924
B45-1010-IPL-VV	136	924
B45-1010-IPL-YY	136	751
B45-1020-00L-BB	136	1101
B45-1020-00L-CC	136	734
B45-1020-00L-GG	136	1615
B45-1020-00L-KK	136	954
B45-1020-00L-LL	136	1101
B45-1020-00L-NN	136	954
B45-1020-00L-TT	136	1174
B45-1020-00L-VV	136	1174
B45-1020-00L-YY	136	954
B45-1100-00-BB	137	3423
B45-1100-00-CC	137	2282

CODE	PAGE	PRICE
B45-1100-00-GG	137	5021
B45-1100-00-KK	137	2967
B45-1100-00-LL	137	3423
B45-1100-00-NN	137	2967
B45-1100-00-TT	137	3652
B45-1100-00-VV	137	3652
B45-1100-00-YY	137	2967
B45-1269-00-BB	137	1688
B45-1269-00-CC	137	1125
B45-1269-00-GG	137	2475
B45-1269-00-KK	137	1463
B45-1269-00-LL	137	1688
B45-1269-00-NN	137	1463
B45-1269-00-TT	137	1800
B45-1269-00-VV	137	1800
B45-1269-00-YY	137	1463
B45-1600-00-BB	138	1708
B45-1600-00-CC	138	1138
B45-1600-00-GG	138	2505
B45-1600-00-KK	138	1480
B45-1600-00-LL	138	1708
B45-1600-00-NN	138	1480
B45-1600-00-TT	138	1822
B45-1600-00-VV	138	1822
B45-1600-00-YY	138	1480
B45-2002-00-BB	138	3176
B45-2002-00-CC	138	2118
B45-2002-00-GG	138	4659
B45-2002-00-KK	138	2753
B45-2002-00-LL	138	3176
B45-2002-00-NN	138	2753
B45-2002-00-TT	138	3388
B45-2002-00-VV	138	3388
B45-2002-00-YY	138	2753
B45-8009-00L-BB	136	1418
B45-8009-00L-CC	136	945
B45-8009-00L-GG	136	2079
B45-8009-00L-KK	136	1229
B45-8009-00L-LL	136	1418
B45-8009-00L-NN	136	1229
B45-8009-00L-TT	136	1512
B45-8009-00L-VV	136	1512
B45-8009-00L-YY	136	1229
B45-8100-04L-BB	137	1168
B45-8100-04L-CC	137	779
B45-8100-04L-GG	137	1714
B45-8100-04L-KK	137	1013
B45-8100-04L-LL	137	1168
B45-8100-04L-NN	137	1013
B45-8100-04L-TT	137	1246
B45-8100-04L-VV	137	1246
B45-8100-04L-YY	137	1013
B45-9100-00-BB	138	798
B45-9100-00-CC	138	635
B45-9100-00-GG	138	1025
B45-9100-00-KK	138	733
B45-9100-00-LL	138	798
B45-9100-00-NN	138	733

Actual products may differ from pictures. Actual products measures may differ from the measures shown. All USD prices are subject to change without notice. Effective as of August 2023.

PRICE INDEX

CODE	PAGE	PRICE
B45-9100-00-TT	138	830
B45-9100-00-VV	138	830
B45-9100-00-YY	138	733
B45-9180-00-BB	139	996
B45-9180-00-CC	139	822
B45-9180-00-GG	139	1240
B45-9180-00-KK	139	926
B45-9180-00-LL	139	996
B45-9180-00-NN	139	926
B45-9180-00-TT	139	1031
B45-9180-00-VV	139	1031
B45-9180-00-YY	139	926
B45-9190-00-BB	139	1051
B45-9190-00-CC	139	877
B45-9190-00-GG	139	1295
B45-9190-00-KK	139	981
B45-9190-00-LL	139	1051
B45-9190-00-NN	139	981
B45-9190-00-TT	139	1086
B45-9190-00-VV	139	1086
B45-9190-00-YY	139	981
B45-9404-00-BB	139	1428
B45-9404-00-CC	139	1179
B45-9404-00-GG	139	1775
B45-9404-00-KK	139	1328
B45-9404-00-LL	139	1428
B45-9404-00-NN	139	1328
B45-9404-00-TT	139	1477
B45-9404-00-VV	139	1477
B45-9404-00-YY	139	1328
B45-9453-00-BB	140	1395
B45-9453-00-CC	140	1146
B45-9453-00-GG	140	1742
B45-9453-00-KK	140	1295
B45-9453-00-LL	140	1395
B45-9453-00-NN	140	1295
B45-9453-00-TT	140	1444
B45-9453-00-VV	140	1444
B45-9453-00-YY	140	1295
B45-9521-00-BB	140	1279
B45-9521-00-CC	140	1081
B45-9521-00-GG	140	1556
B45-9521-00-KK	140	1200
B45-9521-00-LL	140	1279
B45-9521-00-NN	140	1200
B45-9521-00-TT	140	1319
B45-9521-00-VV	140	1319
B45-9521-00-YY	140	1200
B45-9531-00-BB	141	1389
B45-9531-00-CC	141	1191
B45-9531-00-GG	141	1666
B45-9531-00-KK	141	1310
B45-9531-00-LL	141	1389
B45-9531-00-NN	141	1310
B45-9531-00-TT	141	1429
B45-9531-00-VV	141	1429
B45-9531-00-YY	141	1310
B45-9560-02-BB	141	598

CODE	PAGE	PRICE
B45-9560-02-CC	141	498
B45-9560-02-GG	141	737
B45-9560-02-KK	141	558
B45-9560-02-LL	141	598
B45-9560-02-NN	141	558
B45-9560-02-TT	141	617
B45-9560-02-VV	141	617
B45-9560-02-YY	141	558
B45-9560-03-BB	142	680
B45-9560-03-CC	142	580
B45-9560-03-GG	142	819
B45-9560-03-KK	142	640
B45-9560-03-LL	142	680
B45-9560-03-NN	142	640
B45-9560-03-TT	142	699
B45-9560-03-VV	142	699
B45-9560-03-YY	142	640
B45-9600-00-BB	142	473
B45-9600-00-CC	142	373
B45-9600-00-GG	142	612
B45-9600-00-KK	142	433
B45-9600-00-LL	142	473
B45-9600-00-NN	142	433
B45-9600-00-TT	142	492
B45-9600-00-VV	142	492
B45-9600-00-YY	142	433
B45-9649-00-BB	142	534
B45-9649-00-CC	142	434
B45-9649-00-GG	142	673
B45-9649-00-KK	142	494
B45-9649-00-LL	142	534
B45-9649-00-NN	142	494
B45-9649-00-TT	142	553
B45-9649-00-VV	142	553
B45-9649-00-YY	142	494
B46-1010-00L-BB	152	866
B46-1010-00L-CC	152	577
B46-1010-00L-GG	152	1264
B46-1010-00L-KK	152	750
B46-1010-00L-LL	152	866
B46-1010-00L-NN	152	750
B46-1010-00L-TT	152	923
B46-1010-00L-VV	152	923
B46-1010-00L-YY	152	750
B46-1010-1PL-BB	152	938
B46-1010-1PL-CC	152	625
B46-1010-1PL-GG	152	1375
B46-1010-1PL-KK	152	813
B46-1010-1PL-LL	152	938
B46-1010-1PL-NN	152	813
B46-1010-1PL-TT	152	1000
B46-1010-1PL-VV	152	1000
B46-1010-1PL-YY	152	813
B46-1020-00L-BB	152	1163
B46-1020-00L-CC	152	775
B46-1020-00L-GG	152	1705
B46-1020-00L-KK	152	1008
B46-1020-00L-LL	152	1163

CODE	PAGE	PRICE
B46-1020-00L-NN	152	1008
B46-1020-00L-TT	152	1240
B46-1020-00L-VV	152	1240
B46-1020-00L-YY	152	1008
B46-1030-00L-BB	152	1037
B46-1030-00L-CC	152	691
B46-1030-00L-GG	152	1515
B46-1030-00L-KK	152	898
B46-1030-00L-LL	152	1037
B46-1030-00L-NN	152	898
B46-1030-00L-TT	152	1105
B46-1030-00L-VV	152	1105
B46-1030-00L-YY	152	898
B46-1030-1PL-BB	152	1109
B46-1030-1PL-CC	152	739
B46-1030-1PL-GG	152	1626
B46-1030-1PL-KK	152	961
B46-1030-1PL-LL	152	1109
B46-1030-1PL-NN	152	961
B46-1030-1PL-TT	152	1182
B46-1030-1PL-VV	152	1182
B46-1030-1PL-YY	152	961
B46-1035-00L-BB	152	1271
B46-1035-00L-CC	152	847
B46-1035-00L-GG	152	1858
B46-1035-00L-KK	152	1101
B46-1035-00L-LL	152	1271
B46-1035-00L-NN	152	1101
B46-1035-00L-TT	152	1355
B46-1035-00L-VV	152	1355
B46-1035-00L-YY	152	1101
B46-1035-1PL-BB	152	1343
B46-1035-1PL-CC	152	895
B46-1035-1PL-GG	152	1969
B46-1035-1PL-KK	152	1164
B46-1035-1PL-LL	152	1343
B46-1035-1PL-NN	152	1164
B46-1035-1PL-TT	152	1432
B46-1035-1PL-VV	152	1432
B46-1035-1PL-YY	152	1164
B46-1040-00L-BB	153	1313
B46-1040-00L-CC	153	875
B46-1040-00L-GG	153	1925
B46-1040-00L-KK	153	1138
B46-1040-00L-LL	153	1313
B46-1040-00L-NN	153	1138
B46-1040-00L-TT	153	1400
B46-1040-00L-VV	153	1400
B46-1040-00L-YY	153	1138
B46-1100-00-BB	154	3593
B46-1100-00-CC	154	2395
B46-1100-00-GG	154	5269
B46-1100-00-KK	154	3114
B46-1100-00-LL	154	3593
B46-1100-00-NN	154	3114
B46-1100-00-TT	154	3832
B46-1100-00-VV	154	3832
B46-1100-00-YY	154	3114

Finishes:

CC = chrome, CD = chrome diamond, CF = smokey chrome, KK = matte black, LL = satin brass, BB = white, NN = brushed nickel, YY = polished nickel, TT = venetian bronze, VV = satin copper, GG = gold, KM = black titanium, CB = chrome white, KB = matte black white, LB = satin brass white, NB = brushed nickel white, YB = polished nickel white, TB = venetian bronze, VB = satin copper white, GB = gold white

PRICE INDEX

CODE	PAGE	PRICE
B46-1249-00-BB	154	1793
B46-1249-00-CC	154	1195
B46-1249-00-GG	154	2629
B46-1249-00-KK	154	1554
B46-1249-00-LL	154	1793
B46-1249-00-NN	154	1554
B46-1249-00-TT	154	1912
B46-1249-00-VV	154	1912
B46-1249-00-YY	154	1554
B46-2001-00-BB	154	3176
B46-2001-00-CC	154	2118
B46-2001-00-GG	154	4659
B46-2001-00-KK	154	2753
B46-2001-00-LL	154	3176
B46-2001-00-NN	154	2753
B46-2001-00-TT	154	3388
B46-2001-00-VV	154	3388
B46-2001-00-YY	154	2753
B46-8009-00L-BB	153	1463
B46-8009-00L-CC	153	975
B46-8009-00L-GG	153	2145
B46-8009-00L-KK	153	1268
B46-8009-00L-LL	153	1463
B46-8009-00L-NN	153	1268
B46-8009-00L-TT	153	1560
B46-8009-00L-VV	153	1560
B46-8009-00L-YY	153	1268
B46-8100-04L-BB	153	1193
B46-8100-04L-CC	153	795
B46-8100-04L-GG	153	1749
B46-8100-04L-KK	153	1034
B46-8100-04L-LL	153	1193
B46-8100-04L-NN	153	1034
B46-8100-04L-TT	153	1272
B46-8100-04L-VV	153	1272
B46-8100-04L-YY	153	1034
B46-9100-00-BB	155	813
B46-9100-00-CC	155	645
B46-9100-00-GG	155	1047
B46-9100-00-KK	155	746
B46-9100-00-LL	155	813
B46-9100-00-NN	155	746
B46-9100-00-TT	155	846
B46-9100-00-VV	155	846
B46-9100-00-YY	155	746
B46-9180-00-BB	155	1025
B46-9180-00-CC	155	841
B46-9180-00-GG	155	1281
B46-9180-00-KK	155	951
B46-9180-00-LL	155	1025
B46-9180-00-NN	155	951
B46-9180-00-TT	155	1061
B46-9180-00-VV	155	1061
B46-9180-00-YY	155	951
B46-9404-00-BB	155	1458
B46-9404-00-CC	155	1199
B46-9404-00-GG	155	1819
B46-9404-00-KK	155	1354

CODE	PAGE	PRICE
B46-9404-00-LL	155	1458
B46-9404-00-NN	155	1354
B46-9404-00-TT	155	1509
B46-9404-00-VV	155	1509
B46-9404-00-YY	155	1354
B46-9453-00-BB	156	1425
B46-9453-00-CC	156	1166
B46-9453-00-GG	156	1786
B46-9453-00-KK	156	1321
B46-9453-00-LL	156	1425
B46-9453-00-NN	156	1321
B46-9453-00-TT	156	1476
B46-9453-00-VV	156	1476
B46-9453-00-YY	156	1321
B46-9521-00-BB	156	1335
B46-9521-00-CC	156	1118
B46-9521-00-GG	156	1638
B46-9521-00-KK	156	1248
B46-9521-00-LL	156	1335
B46-9521-00-NN	156	1248
B46-9521-00-TT	156	1378
B46-9521-00-VV	156	1378
B46-9521-00-YY	156	1248
B46-9531-00-BB	157	1445
B46-9531-00-CC	157	1228
B46-9531-00-GG	157	1748
B46-9531-00-KK	157	1358
B46-9531-00-LL	157	1445
B46-9531-00-NN	157	1358
B46-9531-00-TT	157	1488
B46-9531-00-VV	157	1488
B46-9531-00-YY	157	1358
B46-9560-02-BB	157	620
B46-9560-02-CC	157	513
B46-9560-02-GG	157	770
B46-9560-02-KK	157	577
B46-9560-02-LL	157	620
B46-9560-02-NN	157	577
B46-9560-02-TT	157	641
B46-9560-02-VV	157	641
B46-9560-02-YY	157	577
B46-9560-03-BB	158	702
B46-9560-03-CC	158	595
B46-9560-03-GG	158	852
B46-9560-03-KK	158	659
B46-9560-03-LL	158	702
B46-9560-03-NN	158	659
B46-9560-03-TT	158	723
B46-9560-03-VV	158	723
B46-9560-03-YY	158	659
B46-9649-00-BB	158	556
B46-9649-00-CC	158	449
B46-9649-00-GG	158	706
B46-9649-00-KK	158	513
B46-9649-00-LL	158	556
B46-9649-00-NN	158	513
B46-9649-00-TT	158	577
B46-9649-00-VV	158	577

CODE	PAGE	PRICE
B46-9649-00-YY	158	513
B47-1080-00L-Bx	168	1559
B47-1080-00L-Cx	168	1039
B47-1080-00L-Gx	168	2280
B47-1080-00L-Kx	168	1350
B47-1080-00L-Lx	168	1559
B47-1080-00L-Nx	168	1350
B47-1080-00L-Tx	168	1662
B47-1080-00L-Vx	168	1662
B47-1080-00L-Yx	168	1350
B47-1080-1PL-Bx	168	1631
B47-1080-1PL-Cx	168	1087
B47-1080-1PL-Gx	168	2391
B47-1080-1PL-Kx	168	1413
B47-1080-1PL-Lx	168	1631
B47-1080-1PL-Nx	168	1413
B47-1080-1PL-Tx	168	1739
B47-1080-1PL-Vx	168	1739
B47-1080-1PL-Yx	168	1413
B47-1100-00-Bx	169	5460
B47-1100-00-Cx	169	3640
B47-1100-00-Gx	169	8008
B47-1100-00-Kx	169	4732
B47-1100-00-Lx	169	5460
B47-1100-00-Nx	169	4732
B47-1100-00-Tx	169	5824
B47-1100-00-Vx	169	5824
B47-1100-00-Yx	169	4732
B47-1349-00-Bx	170	2301
B47-1349-00-Cx	170	1534
B47-1349-00-Gx	170	3375
B47-1349-00-Kx	170	1994
B47-1349-00-Lx	170	2301
B47-1349-00-Nx	170	1994
B47-1349-00-Tx	170	2454
B47-1349-00-Vx	170	2454
B47-1349-00-Yx	170	1994
B47-8009-00L-Bx	169	1872
B47-8009-00L-Cx	169	1248
B47-8009-00L-Gx	169	2746
B47-8009-00L-Kx	169	1622
B47-8009-00L-Lx	169	1872
B47-8009-00L-Nx	169	1622
B47-8009-00L-Tx	169	1997
B47-8009-00L-Vx	169	1997
B47-8009-00L-Yx	169	1622
B47-8100-00L-Bx	169	1497
B47-8100-00L-Cx	169	998
B47-8100-00L-Gx	169	2196
B47-8100-00L-Kx	169	1297
B47-8100-00L-Lx	169	1497
B47-8100-00L-Nx	169	1297
B47-8100-00L-Tx	169	1597
B47-8100-00L-Vx	169	1597
B47-8100-00L-Yx	169	1297
B47-9453-00-Bx	170	1548
B47-9453-00-Cx	170	1248
B47-9453-00-Gx	170	2147

Actual products may differ from pictures. Actual products measures may differ from the measures shown. All USD prices are subject to change without notice. Effective as of August 2023.

PRICE INDEX

CODE	PAGE	PRICE
B47-9453-00-Kx	170	1428
B47-9453-00-Lx	170	1548
B47-9453-00-Nx	170	1428
B47-9453-00-Tx	170	1607
B47-9453-00-Vx	170	1607
B47-9453-00-Yx	170	1428
B47-9560-02-Bx	170	775
B47-9560-02-Cx	170	616
B47-9560-02-Gx	170	996
B47-9560-02-Kx	170	711
B47-9560-02-Lx	170	775
B47-9560-02-Nx	170	711
B47-9560-02-Tx	170	806
B47-9560-02-Vx	170	806
B47-9560-02-Yx	170	711
B47-9560-03-Bx	171	857
B47-9560-03-Cx	171	698
B47-9560-03-Gx	171	1078
B47-9560-03-Kx	171	793
B47-9560-03-Lx	171	857
B47-9560-03-Nx	171	793
B47-9560-03-Tx	171	888
B47-9560-03-Vx	171	888
B47-9560-03-Yx	171	793
B47-9600-00-Bx	171	650
B47-9600-00-Cx	171	491
B47-9600-00-Gx	171	871
B47-9600-00-Kx	171	586
B47-9600-00-Lx	171	650
B47-9600-00-Nx	171	586
B47-9600-00-Tx	171	681
B47-9600-00-Vx	171	681
B47-9600-00-Yx	171	586
B47-9649-00-Bx	171	711
B47-9649-00-Cx	171	552
B47-9649-00-Gx	171	932
B47-9649-00-Kx	171	647
B47-9649-00-Lx	171	711
B47-9649-00-Nx	171	647
B47-9649-00-Tx	171	742
B47-9649-00-Vx	171	742
B47-9649-00-Yx	171	647
B51-1010-00L-BB	180	1254
B51-1010-00L-CC	180	846
B51-1010-00L-CF	180	846
B51-1010-00L-KK	180	1086
B51-1010-1PL-BB	180	1326
B51-1010-1PL-CC	180	894
B51-1010-1PL-CF	180	894
B51-1010-1PL-KK	180	1149
B51-1469-00-BB	180	2383
B51-1469-00-CC	180	1589
B51-1469-00-CF	180	1589
B51-1469-00-KK	180	2066
B51-8009-00L-BB	180	1708
B51-8009-00L-CC	180	1138
B51-8009-00L-CF	180	1138
B51-8009-00L-KK	180	1480

CODE	PAGE	PRICE
B51-8100-00L-BB	180	1101
B51-8100-00L-CC	180	734
B51-8100-00L-CF	180	734
B51-8100-00L-KK	180	954
B51-9521-00-BB	181	1613
B51-9521-00-CC	181	1303
B51-9521-00-CF	181	1303
B51-9521-00-KK	181	1489
B51-9531-00-BB	181	1723
B51-9531-00-CC	181	1413
B51-9531-00-CF	181	1413
B51-9531-00-KK	181	1599
B56-1010-00L-CB	186	791
B56-1010-00L-CC	186	791
B56-1010-00L-CF	186	791
B56-1010-1PL-CB	186	839
B56-1010-1PL-CC	186	839
B56-1010-1PL-CF	186	839
B56-1100-00-CB	186	3496
B56-1100-00-CC	186	3496
B56-1100-00-CF	186	3496
B56-1249-00-CB	187	1497
B56-1249-00-CC	187	1497
B56-1249-00-CF	187	1497
B56-8009-00L-CB	186	1218
B56-8009-00L-CC	186	1218
B56-8009-00L-CF	186	1218
B56-9404-00-CB	187	1323
B56-9404-00-CC	187	1323
B56-9404-00-CF	187	1323
B56-9521-00-CB	187	1303
B56-9521-00-CC	187	1303
B56-9521-00-CF	187	1303
B56-9531-00-CB	188	1413
B56-9531-00-CC	188	1413
B56-9531-00-CF	188	1413
B56-9560-02-CB	188	596
B56-9560-02-CC	188	596
B56-9560-02-CF	188	596
B56-9560-03-CB	189	678
B56-9560-03-CC	189	678
B56-9560-03-CF	189	678
B56-9649-00-CB	189	532
B56-9649-00-CC	189	532
B56-9649-00-CF	189	532
B66-1005-00L-BB	196	642
B66-1005-00L-CC	196	428
B66-1005-00L-GG	196	937
B66-1005-00L-KK	196	556
B66-1005-00L-LL	196	642
B66-1005-00L-NN	196	556
B66-1005-00L-TT	196	685
B66-1005-00L-VV	196	685
B66-1005-00L-YY	196	556
B66-1005-1PL-BB	196	714
B66-1005-1PL-CC	196	476
B66-1005-1PL-GG	196	1048
B66-1005-1PL-KK	196	619

CODE	PAGE	PRICE
B66-1005-1PL-LL	196	714
B66-1005-1PL-NN	196	619
B66-1005-1PL-TT	196	762
B66-1005-1PL-VV	196	762
B66-1005-1PL-YY	196	619
B66-1010-01L-BB	196	665
B66-1010-01L-CC	196	443
B66-1010-01L-GG	196	969
B66-1010-01L-KK	196	575
B66-1010-01L-LL	196	665
B66-1010-01L-NN	196	575
B66-1010-01L-TT	196	709
B66-1010-01L-VV	196	709
B66-1010-01L-YY	196	575
B66-1010-1PL-BB	196	737
B66-1010-1PL-CC	196	491
B66-1010-1PL-GG	196	1080
B66-1010-1PL-KK	196	638
B66-1010-1PL-LL	196	737
B66-1010-1PL-NN	196	638
B66-1010-1PL-TT	196	786
B66-1010-1PL-VV	196	786
B66-1010-1PL-YY	196	638
B66-1020-00L-BB	196	910
B66-1020-00L-CC	196	607
B66-1020-00L-GG	196	1335
B66-1020-00L-KK	196	789
B66-1020-00L-LL	196	910
B66-1020-00L-NN	196	789
B66-1020-00L-TT	196	971
B66-1020-00L-VV	196	971
B66-1020-00L-YY	196	789
B66-1030-00L-BB	196	990
B66-1030-00L-CC	196	660
B66-1030-00L-GG	196	1447
B66-1030-00L-KK	196	857
B66-1030-00L-LL	196	990
B66-1030-00L-NN	196	857
B66-1030-00L-TT	196	1056
B66-1030-00L-VV	196	1056
B66-1030-00L-YY	196	857
B66-1030-1PL-BB	196	1062
B66-1030-1PL-CC	196	708
B66-1030-1PL-GG	196	1558
B66-1030-1PL-KK	196	920
B66-1030-1PL-LL	196	1062
B66-1030-1PL-NN	196	920
B66-1030-1PL-TT	196	1133
B66-1030-1PL-VV	196	1133
B66-1030-1PL-YY	196	920
B66-1100-02-BB	199	3048
B66-1100-02-CC	199	2032
B66-1100-02-GG	199	4470
B66-1100-02-KK	199	2642
B66-1100-02-LL	199	3048
B66-1100-02-NN	199	2642
B66-1100-02-TT	199	3251
B66-1100-02-VV	199	3251

Finishes:

CC = chrome, CD = chrome diamond, CF = smokey chrome, KK = matte black, LL = satin brass, BB = white, NN = brushed nickel, YY = polished nickel, TT = venetian bronze, VV = satin copper, GG = gold, KM = black titanium, CB = chrome white, KB = matte black white, LB = satin brass white, NB = brushed nickel white, YB = polished nickel white, TB = venetian bronze, VB = satin copper white, GB = gold white

PRICE INDEX

CODE	PAGE	PRICE
B66-1100-02-YY	199	2642
B66-1249-00-BB	199	1613
B66-1249-00-CC	199	1075
B66-1249-00-GG	199	2365
B66-1249-00-KK	199	1398
B66-1249-00-LL	199	1613
B66-1249-00-NN	199	1398
B66-1249-00-TT	199	1720
B66-1249-00-VV	199	1720
B66-1249-00-YY	199	1398
B66-1369-03-BB	199	1793
B66-1369-03-CC	199	1195
B66-1369-03-GG	199	2629
B66-1369-03-KK	199	1554
B66-1369-03-LL	199	1793
B66-1369-03-NN	199	1554
B66-1369-03-TT	199	1912
B66-1369-03-VV	199	1912
B66-1369-03-YY	199	1554
B66-1600-00-BB	200	1438
B66-1600-00-CC	200	959
B66-1600-00-GG	200	2109
B66-1600-00-KK	200	1246
B66-1600-00-LL	200	1438
B66-1600-00-NN	200	1246
B66-1600-00-TT	200	1534
B66-1600-00-VV	200	1534
B66-1600-00-YY	200	1246
B66-2001-00-BB	200	2958
B66-2001-00-CC	200	1972
B66-2001-00-GG	200	4338
B66-2001-00-KK	200	2564
B66-2001-00-LL	200	2958
B66-2001-00-NN	200	2564
B66-2001-00-TT	200	3155
B66-2001-00-VV	200	3155
B66-2001-00-YY	200	2564
B66-2001-PB-BB	200	2958
B66-2001-PB-CC	200	1972
B66-2001-PB-GG	200	4338
B66-2001-PB-KK	200	2564
B66-2001-PB-LL	200	2958
B66-2001-PB-NN	200	2564
B66-2001-PB-TT	200	3155
B66-2001-PB-VV	200	3155
B66-2001-PB-YY	200	2564
B66-8009-00L-BB	197	1228
B66-8009-00L-CC	197	819
B66-8009-00L-GG	197	1801
B66-8009-00L-KK	197	1064
B66-8009-00L-LL	197	1228
B66-8009-00L-NN	197	1064
B66-8009-00L-TT	197	1310
B66-8009-00L-VV	197	1310
B66-8009-00L-YY	197	1064
B66-8029-00L-BB	197	1424
B66-8029-00L-CC	197	949
B66-8029-00L-GG	197	2088

CODE	PAGE	PRICE
B66-8029-00L-KK	197	1234
B66-8029-00L-LL	197	1424
B66-8029-00L-NN	197	1234
B66-8029-00L-TT	197	1518
B66-8029-00L-VV	197	1518
B66-8029-00L-YY	197	1234
B66-8100-02L-BB	197	1083
B66-8100-02L-CC	197	722
B66-8100-02L-GG	197	1588
B66-8100-02L-KK	197	939
B66-8100-02L-LL	197	1083
B66-8100-02L-NN	197	939
B66-8100-02L-TT	197	1155
B66-8100-02L-VV	197	1155
B66-8100-02L-YY	197	939
B66-8100-04L-BB	198	1083
B66-8100-04L-CC	198	722
B66-8100-04L-GG	198	1588
B66-8100-04L-KK	198	939
B66-8100-04L-LL	198	1083
B66-8100-04L-NN	198	939
B66-8100-04L-TT	198	1155
B66-8100-04L-VV	198	1155
B66-8100-04L-YY	198	939
B66-8120-04L-BB	198	1205
B66-8120-04L-CC	198	804
B66-8120-04L-GG	198	1768
B66-8120-04L-KK	198	1045
B66-8120-04L-LL	198	1205
B66-8120-04L-NN	198	1045
B66-8120-04L-TT	198	1286
B66-8120-04L-VV	198	1286
B66-8120-04L-YY	198	1045
B66-9120-00-BB	201	654
B66-9120-00-CC	201	539
B66-9120-00-GG	201	814
B66-9120-00-KK	201	608
B66-9120-00-LL	201	654
B66-9120-00-NN	201	608
B66-9120-00-TT	201	676
B66-9120-00-VV	201	676
B66-9120-00-YY	201	608
B66-9181-00-BB	201	923
B66-9181-00-CC	201	773
B66-9181-00-GG	201	1132
B66-9181-00-KK	201	863
B66-9181-00-LL	201	923
B66-9181-00-NN	201	863
B66-9181-00-TT	201	952
B66-9181-00-VV	201	952
B66-9181-00-YY	201	863
B66-9190-00-BB	202	978
B66-9190-00-CC	202	828
B66-9190-00-GG	202	1187
B66-9190-00-KK	202	918
B66-9190-00-LL	202	978
B66-9190-00-NN	202	918
B66-9190-00-TT	202	1007

CODE	PAGE	PRICE
B66-9190-00-VV	202	1007
B66-9190-00-YY	202	918
B66-9404-00-BB	202	1350
B66-9404-00-CC	202	1127
B66-9404-00-GG	202	1661
B66-9404-00-KK	202	1261
B66-9404-00-LL	202	1350
B66-9404-00-NN	202	1261
B66-9404-00-TT	202	1394
B66-9404-00-VV	202	1394
B66-9404-00-YY	202	1261
B66-9453-00-BB	202	1317
B66-9453-00-CC	202	1094
B66-9453-00-GG	202	1628
B66-9453-00-KK	202	1228
B66-9453-00-LL	202	1317
B66-9453-00-NN	202	1228
B66-9453-00-TT	202	1361
B66-9453-00-VV	202	1361
B66-9453-00-YY	202	1228
B66-9521-00-BB	203	1261
B66-9521-00-CC	203	1069
B66-9521-00-GG	203	1530
B66-9521-00-KK	203	1184
B66-9521-00-LL	203	1261
B66-9521-00-NN	203	1184
B66-9521-00-TT	203	1299
B66-9521-00-VV	203	1299
B66-9521-00-YY	203	1184
B66-9531-00-BB	203	1371
B66-9531-00-CC	203	1179
B66-9531-00-GG	203	1640
B66-9531-00-KK	203	1294
B66-9531-00-LL	203	1371
B66-9531-00-NN	203	1294
B66-9531-00-TT	203	1409
B66-9531-00-VV	203	1409
B66-9531-00-YY	203	1294
B66-9560-02-BB	204	581
B66-9560-02-CC	204	487
B66-9560-02-GG	204	713
B66-9560-02-KK	204	543
B66-9560-02-LL	204	581
B66-9560-02-NN	204	543
B66-9560-02-TT	204	600
B66-9560-02-VV	204	600
B66-9560-02-YY	204	543
B66-9560-03-BB	204	663
B66-9560-03-CC	204	569
B66-9560-03-GG	204	795
B66-9560-03-KK	204	625
B66-9560-03-LL	204	663
B66-9560-03-NN	204	625
B66-9560-03-TT	204	682
B66-9560-03-VV	204	682
B66-9560-03-YY	204	625
B66-9600-00-BB	204	456
B66-9600-00-CC	204	362

Actual products may differ from pictures. Actual products measures may differ from the measures shown. All USD prices are subject to change without notice. Effective as of August 2023.

PRICE INDEX

CODE	PAGE	PRICE
B66-9600-00-GG	204	588
B66-9600-00-KK	204	418
B66-9600-00-LL	204	456
B66-9600-00-NN	204	418
B66-9600-00-TT	204	475
B66-9600-00-VV	204	475
B66-9600-00-YY	204	418
B66-9649-00-BB	205	517
B66-9649-00-CC	205	423
B66-9649-00-GG	205	649
B66-9649-00-KK	205	479
B66-9649-00-LL	205	517
B66-9649-00-NN	205	479
B66-9649-00-TT	205	536
B66-9649-00-VV	205	536
B66-9649-00-YY	205	479
B71-1201-01-BB	217	1793
B71-1201-01-CC	217	1195
B71-1201-01-GG	217	2629
B71-1201-01-KK	217	1554
B71-1201-01-LL	217	1793
B71-1201-01-NN	217	1554
B71-1201-01-TT	217	1912
B71-1201-01-VV	217	1912
B71-1201-01-YY	217	1554
B71-8001-01L-BB	216	1552
B71-8001-01L-CC	216	1035
B71-8001-01L-GG	216	2276
B71-8001-01L-KK	216	1345
B71-8001-01L-LL	216	1552
B71-8001-01L-NN	216	1345
B71-8001-01L-TT	216	1656
B71-8001-01L-VV	216	1656
B71-8001-01L-YY	216	1345
B71-8041-00L-BB	216	1517
B71-8041-00L-CC	216	1011
B71-8041-00L-GG	216	2225
B71-8041-00L-KK	216	1314
B71-8041-00L-LL	216	1517
B71-8041-00L-NN	216	1314
B71-8041-00L-TT	216	1618
B71-8041-00L-VV	216	1618
B71-8041-00L-YY	216	1314
B71-9404-00-BB	217	1524
B71-9404-00-CC	217	1243
B71-9404-00-GG	217	1916
B71-9404-00-KK	217	1411
B71-9404-00-LL	217	1524
B71-9404-00-NN	217	1411
B71-9404-00-TT	217	1580
B71-9404-00-VV	217	1580
B71-9404-00-YY	217	1411
B71-9560-02-BB	218	730
B71-9560-02-CC	218	586
B71-9560-02-GG	218	930
B71-9560-02-KK	218	672
B71-9560-02-LL	218	730
B71-9560-02-NN	218	672

CODE	PAGE	PRICE
B71-9560-02-TT	218	758
B71-9560-02-VV	218	758
B71-9560-02-YY	218	672
B71-9560-03-BB	218	812
B71-9560-03-CC	218	668
B71-9560-03-GG	218	1012
B71-9560-03-KK	218	754
B71-9560-03-LL	218	812
B71-9560-03-NN	218	754
B71-9560-03-TT	218	840
B71-9560-03-VV	218	840
B71-9560-03-YY	218	754
B71-9601-00-BB	219	605
B71-9601-00-CC	219	461
B71-9601-00-GG	219	805
B71-9601-00-KK	219	547
B71-9601-00-LL	219	605
B71-9601-00-NN	219	547
B71-9601-00-TT	219	633
B71-9601-00-VV	219	633
B71-9601-00-YY	219	547
B71-9641-00-BB	219	666
B71-9641-00-CC	219	522
B71-9641-00-GG	219	866
B71-9641-00-KK	219	608
B71-9641-00-LL	219	666
B71-9641-00-NN	219	608
B71-9641-00-TT	219	694
B71-9641-00-VV	219	694
B71-9641-00-YY	219	608
B72-1201-01-BB	217	1793
B72-1201-01-CC	217	1195
B72-1201-01-GG	217	2629
B72-1201-01-KK	217	1554
B72-1201-01-LL	217	1793
B72-1201-01-NN	217	1554
B72-1201-01-TT	217	1912
B72-1201-01-VV	217	1912
B72-1201-01-YY	217	1554
B72-8001-01L-BB	216	1552
B72-8001-01L-CC	216	1035
B72-8001-01L-GG	216	2276
B72-8001-01L-KK	216	1345
B72-8001-01L-LL	216	1552
B72-8001-01L-NN	216	1345
B72-8001-01L-TT	216	1656
B72-8001-01L-VV	216	1656
B72-8001-01L-YY	216	1345
B72-8041-00L-BB	216	1517
B72-8041-00L-CC	216	1011
B72-8041-00L-GG	216	2225
B72-8041-00L-KK	216	1314
B72-8041-00L-LL	216	1517
B72-8041-00L-NN	216	1314
B72-8041-00L-TT	216	1618
B72-8041-00L-VV	216	1618
B72-8041-00L-YY	216	1314
B72-9404-00-BB	217	1524

CODE	PAGE	PRICE
B72-9404-00-CC	217	1243
B72-9404-00-GG	217	1916
B72-9404-00-KK	217	1411
B72-9404-00-LL	217	1524
B72-9404-00-NN	217	1411
B72-9404-00-TT	217	1580
B72-9404-00-VV	217	1580
B72-9404-00-YY	217	1411
B72-9560-02-BB	218	730
B72-9560-02-CC	218	586
B72-9560-02-GG	218	930
B72-9560-02-KK	218	672
B72-9560-02-LL	218	730
B72-9560-02-NN	218	672
B72-9560-02-TT	218	758
B72-9560-02-VV	218	758
B72-9560-02-YY	218	672
B72-9560-03-BB	218	812
B72-9560-03-CC	218	668
B72-9560-03-GG	218	1012
B72-9560-03-KK	218	754
B72-9560-03-LL	218	812
B72-9560-03-NN	218	754
B72-9560-03-TT	218	840
B72-9560-03-VV	218	840
B72-9560-03-YY	218	754
B72-9601-00-BB	219	605
B72-9601-00-CC	219	461
B72-9601-00-GG	219	805
B72-9601-00-KK	219	547
B72-9601-00-LL	219	605
B72-9601-00-NN	219	547
B72-9601-00-TT	219	633
B72-9601-00-VV	219	633
B72-9601-00-YY	219	547
B72-9641-00-BB	219	666
B72-9641-00-CC	219	522
B72-9641-00-GG	219	866
B72-9641-00-KK	219	608
B72-9641-00-LL	219	666
B72-9641-00-NN	219	608
B72-9641-00-TT	219	694
B72-9641-00-VV	219	694
B72-9641-00-YY	219	608
B74-1201-01-BB	224	1793
B74-1201-01-CB	224	1195
B74-1201-01-GB	224	2629
B74-1201-01-KB	224	1554
B74-1201-01-LB	224	1793
B74-1201-01-NB	224	1554
B74-1201-01-TB	224	1912
B74-1201-01-VB	224	1912
B74-1201-01-YB	224	1554
B74-9404-00-BB	224	1524
B74-9404-00-CB	224	1243
B74-9404-00-GB	224	1916
B74-9404-00-KB	224	1411
B74-9404-00-LB	224	1524

Finishes:

CC = chrome, CD = chrome diamond, CF = smokey chrome, KK = matte black, LL = satin brass, BB = white, NN = brushed nickel, YY = polished nickel, TT = venetian bronze, VV = satin copper, GG = gold, KM = black titanium, CB = chrome white, KB = matte black white, LB = satin brass white, NB = brushed nickel white, YB = polished nickel white, TB = venetian bronze, VB = satin copper white, GB = gold white

PRICE INDEX

CODE	PAGE	PRICE
B74-9404-00-NB	224	1411
B74-9404-00-TB	224	1580
B74-9404-00-VB	224	1580
B74-9404-00-YB	224	1411
B74-9560-02-BB	225	730
B74-9560-02-CB	225	586
B74-9560-02-GB	225	930
B74-9560-02-KB	225	672
B74-9560-02-LB	225	730
B74-9560-02-NB	225	672
B74-9560-02-TB	225	758
B74-9560-02-VB	225	758
B74-9560-02-YB	225	672
B74-9560-03-BB	225	812
B74-9560-03-CB	225	668
B74-9560-03-GB	225	1012
B74-9560-03-KB	225	754
B74-9560-03-LB	225	812
B74-9560-03-NB	225	754
B74-9560-03-TB	225	840
B74-9560-03-VB	225	840
B74-9560-03-YB	225	754
B74-9601-00-BB	225	605
B74-9601-00-CB	225	461
B74-9601-00-GB	225	805
B74-9601-00-KB	225	547
B74-9601-00-LB	225	605
B74-9601-00-NB	225	547
B74-9601-00-TB	225	633
B74-9601-00-VB	225	633
B74-9601-00-YB	225	547
B74-9641-00-BB	226	666
B74-9641-00-CB	226	522
B74-9641-00-GB	226	866
B74-9641-00-KB	226	608
B74-9641-00-LB	226	666
B74-9641-00-NB	226	608
B74-9641-00-TB	226	694
B74-9641-00-VB	226	694
B74-9641-00-YB	226	608
B80-1031-00L-BB	233	783
B80-1031-00L-CC	233	522
B80-1031-00L-GG	233	1143
B80-1031-00L-KK	233	678
B80-1031-00L-LL	233	783
B80-1031-00L-NN	233	678
B80-1031-00L-TT	233	835
B80-1031-00L-VV	233	835
B80-1031-00L-YY	233	678
B80-1031-1PL-BB	233	855
B80-1031-1PL-CC	233	570
B80-1031-1PL-GG	233	1254
B80-1031-1PL-KK	233	741
B80-1031-1PL-LL	233	855
B80-1031-1PL-NN	233	741
B80-1031-1PL-TT	233	912
B80-1031-1PL-VV	233	912
B80-1031-1PL-YY	233	741

CODE	PAGE	PRICE
B80-1032-00L-BB	234	783
B80-1032-00L-CC	234	522
B80-1032-00L-GG	234	1143
B80-1032-00L-KK	234	678
B80-1032-00L-LL	234	783
B80-1032-00L-NN	234	678
B80-1032-00L-TT	234	835
B80-1032-00L-VV	234	835
B80-1032-00L-YY	234	678
B80-1032-1PL-BB	234	855
B80-1032-1PL-CC	234	570
B80-1032-1PL-GG	234	1254
B80-1032-1PL-KK	234	741
B80-1032-1PL-LL	234	855
B80-1032-1PL-NN	234	741
B80-1032-1PL-TT	234	912
B80-1032-1PL-VV	234	912
B80-1032-1PL-YY	234	741
B80-1101-00-BB	240	3236
B80-1101-00-CC	240	2157
B80-1101-00-GG	240	4745
B80-1101-00-KK	240	2804
B80-1101-00-LL	240	3236
B80-1101-00-NN	240	2804
B80-1101-00-TT	240	3451
B80-1101-00-VV	240	3451
B80-1101-00-YY	240	2804
B80-1102-00-BB	241	3236
B80-1102-00-CC	241	2157
B80-1102-00-GG	241	4745
B80-1102-00-KK	241	2804
B80-1102-00-LL	241	3236
B80-1102-00-NN	241	2804
B80-1102-00-TT	241	3451
B80-1102-00-VV	241	3451
B80-1102-00-YY	241	2804
B80-8001-1PL-BB	235	863
B80-8001-1PL-CC	235	575
B80-8001-1PL-GG	235	1265
B80-8001-1PL-KK	235	748
B80-8001-1PL-LL	235	863
B80-8001-1PL-NN	235	748
B80-8001-1PL-TT	235	920
B80-8001-1PL-VV	235	920
B80-8001-1PL-YY	235	748
B80-8002-1PL-BB	236	863
B80-8002-1PL-CC	236	575
B80-8002-1PL-GG	236	1265
B80-8002-1PL-KK	236	748
B80-8002-1PL-LL	236	863
B80-8002-1PL-NN	236	748
B80-8002-1PL-TT	236	920
B80-8002-1PL-VV	236	920
B80-8002-1PL-YY	236	748
B80-8003-1PL-BB	237	863
B80-8003-1PL-CC	237	575
B80-8003-1PL-GG	237	1265
B80-8003-1PL-KK	237	748

CODE	PAGE	PRICE
B80-8003-1PL-LL	237	863
B80-8003-1PL-NN	237	748
B80-8003-1PL-TT	237	920
B80-8003-1PL-VV	237	920
B80-8003-1PL-YY	237	748
B80-8042-00L-BB	238	863
B80-8042-00L-CC	238	575
B80-8042-00L-GG	238	1265
B80-8042-00L-KK	238	748
B80-8042-00L-LL	238	863
B80-8042-00L-NN	238	748
B80-8042-00L-TT	238	920
B80-8042-00L-VV	238	920
B80-8042-00L-YY	238	748
B80-8102-00L-BB	239	938
B80-8102-00L-CC	239	625
B80-8102-00L-GG	239	1375
B80-8102-00L-KK	239	813
B80-8102-00L-LL	239	938
B80-8102-00L-NN	239	813
B80-8102-00L-TT	239	1000
B80-8102-00L-VV	239	1000
B80-8102-00L-YY	239	813
B80-9101-00-BB	243	628
B80-9101-00-CC	243	522
B80-9101-00-GG	243	776
B80-9101-00-KK	243	586
B80-9101-00-LL	243	628
B80-9101-00-NN	243	586
B80-9101-00-TT	243	649
B80-9101-00-VV	243	649
B80-9101-00-YY	243	586
B80-9102-00-BB	244	628
B80-9102-00-CC	244	522
B80-9102-00-GG	244	776
B80-9102-00-KK	244	586
B80-9102-00-LL	244	628
B80-9102-00-NN	244	586
B80-9102-00-TT	244	649
B80-9102-00-VV	244	649
B80-9102-00-YY	244	586
B80-9181-00-BB	245	887
B80-9181-00-CC	245	749
B80-9181-00-GG	245	1079
B80-9181-00-KK	245	832
B80-9181-00-LL	245	887
B80-9181-00-NN	245	832
B80-9181-00-TT	245	914
B80-9181-00-VV	245	914
B80-9181-00-YY	245	832
B80-9182-00-BB	246	887
B80-9182-00-CC	246	749
B80-9182-00-GG	246	1079
B80-9182-00-KK	246	832
B80-9182-00-LL	246	887
B80-9182-00-NN	246	832
B80-9182-00-TT	246	914
B80-9182-00-VV	246	914

Actual products may differ from pictures. Actual products measures may differ from the measures shown. All USD prices are subject to change without notice. Effective as of August 2023.

PRICE INDEX

CODE	PAGE	PRICE
B80-9182-00-YY	246	832
B80-9191-00-BB	247	942
B80-9191-00-CC	247	804
B80-9191-00-GG	247	1134
B80-9191-00-KK	247	887
B80-9191-00-LL	247	942
B80-9191-00-NN	247	887
B80-9191-00-TT	247	969
B80-9191-00-VV	247	969
B80-9191-00-YY	247	887
B80-9192-00-BB	248	942
B80-9192-00-CC	248	804
B80-9192-00-GG	248	1134
B80-9192-00-KK	248	887
B80-9192-00-LL	248	942
B80-9192-00-NN	248	887
B80-9192-00-TT	248	969
B80-9192-00-VV	248	969
B80-9192-00-YY	248	887
B80-9401-00-BB	249	1320
B80-9401-00-CC	249	1107
B80-9401-00-GG	249	1617
B80-9401-00-KK	249	1235
B80-9401-00-LL	249	1320
B80-9401-00-NN	249	1235
B80-9401-00-TT	249	1362
B80-9401-00-VV	249	1362
B80-9401-00-YY	249	1235
B80-9402-00-BB	250	1320
B80-9402-00-CC	250	1107
B80-9402-00-GG	250	1617
B80-9402-00-KK	250	1235
B80-9402-00-LL	250	1320
B80-9402-00-NN	250	1235
B80-9402-00-TT	250	1362
B80-9402-00-VV	250	1362
B80-9402-00-YY	250	1235
B80-9453-00-BB	251	1287
B80-9453-00-CC	251	1074
B80-9453-00-GG	251	1584
B80-9453-00-KK	251	1202
B80-9453-00-LL	251	1287
B80-9453-00-NN	251	1202
B80-9453-00-TT	251	1329
B80-9453-00-VV	251	1329
B80-9453-00-YY	251	1202
B80-9521-00-BB	252	1233
B80-9521-00-CC	252	1050
B80-9521-00-GG	252	1488
B80-9521-00-KK	252	1160
B80-9521-00-LL	252	1233
B80-9521-00-NN	252	1160
B80-9521-00-TT	252	1269
B80-9521-00-VV	252	1269
B80-9521-00-YY	252	1160
B80-9522-00-BB	254	1233
B80-9522-00-CC	254	1050
B80-9522-00-GG	254	1488

CODE	PAGE	PRICE
B80-9522-00-KK	254	1160
B80-9522-00-LL	254	1233
B80-9522-00-NN	254	1160
B80-9522-00-TT	254	1269
B80-9522-00-VV	254	1269
B80-9522-00-YY	254	1160
B80-9531-00-BB	256	1343
B80-9531-00-CC	256	1160
B80-9531-00-GG	256	1598
B80-9531-00-KK	256	1270
B80-9531-00-LL	256	1343
B80-9531-00-NN	256	1270
B80-9531-00-TT	256	1379
B80-9531-00-VV	256	1379
B80-9531-00-YY	256	1270
B80-9532-00-BB	258	1343
B80-9532-00-CC	258	1160
B80-9532-00-GG	258	1598
B80-9532-00-KK	258	1270
B80-9532-00-LL	258	1343
B80-9532-00-NN	258	1270
B80-9532-00-TT	258	1379
B80-9532-00-VV	258	1379
B80-9532-00-YY	258	1270
B80-9560-02-BB	260	449
B80-9560-02-CC	260	399
B80-9560-02-GG	260	519
B80-9560-02-KK	260	429
B80-9560-02-LL	260	449
B80-9560-02-NN	260	429
B80-9560-02-TT	260	459
B80-9560-02-VV	260	459
B80-9560-02-YY	260	429
B80-9560-03-BB	261	531
B80-9560-03-CC	261	481
B80-9560-03-GG	261	601
B80-9560-03-KK	261	511
B80-9560-03-LL	261	531
B80-9560-03-NN	261	511
B80-9560-03-TT	261	541
B80-9560-03-VV	261	541
B80-9560-03-YY	261	511
B80-9649-00-BB	262	385
B80-9649-00-CC	262	335
B80-9649-00-GG	262	455
B80-9649-00-KK	262	365
B80-9649-00-LL	262	385
B80-9649-00-NN	262	365
B80-9649-00-TT	262	395
B80-9649-00-VV	262	395
B80-9649-00-YY	262	365
BEC-0520-22-BB	377	468
BEC-0520-22-CC	377	312
BEC-0520-22-GG	377	686
BEC-0520-22-KK	377	406
BEC-0520-22-LL	377	468
BEC-0520-22-NN	377	406
BEC-0520-22-TT	377	499

CODE	PAGE	PRICE
BEC-0520-22-VV	377	499
BEC-0520-22-YY	377	406
BEC-0520-26-BB	377	149
BEC-0520-26-CC	377	99
BEC-0520-26-GG	377	218
BEC-0520-26-KK	377	129
BEC-0520-26-LL	377	149
BEC-0520-26-NN	377	129
BEC-0520-26-TT	377	158
BEC-0520-26-VV	377	158
BEC-0520-26-YY	377	129
BEC-0520-37-BB	377	329
BEC-0520-37-CC	377	219
BEC-0520-37-GG	377	482
BEC-0520-37-KK	377	285
BEC-0520-37-LL	377	329
BEC-0520-37-NN	377	285
BEC-0520-37-TT	377	350
BEC-0520-37-VV	377	350
BEC-0520-37-YY	377	285
BEC-0520-39-BB	377	539
BEC-0520-39-CC	377	359
BEC-0520-39-GG	377	790
BEC-0520-39-KK	377	467
BEC-0520-39-LL	377	539
BEC-0520-39-NN	377	467
BEC-0520-39-TT	377	574
BEC-0520-39-VV	377	574
BEC-0520-39-YY	377	467
BEC-0520-45-BB	377	636
BEC-0520-45-CC	377	424
BEC-0520-45-GG	377	933
BEC-0520-45-KK	377	551
BEC-0520-45-LL	377	636
BEC-0520-45-NN	377	551
BEC-0520-45-TT	377	678
BEC-0520-45-VV	377	678
BEC-0520-45-YY	377	551
BEC-0520-46-BB	378	651
BEC-0520-46-CC	378	434
BEC-0520-46-GG	378	955
BEC-0520-46-KK	378	564
BEC-0520-46-KM	378	694
BEC-0520-46-LL	378	651
BEC-0520-46-NN	378	564
BEC-0520-46-TT	378	694
BEC-0520-46-VV	378	694
BEC-0520-46-YY	378	564
BEC-0520-51-BB	378	479
BEC-0520-51-CC	378	319
BEC-0520-51-CF	378	319
BEC-0520-51-GG	378	702
BEC-0520-51-KK	378	415
BEC-0520-51-LL	378	479
BEC-0520-51-NN	378	415
BEC-0520-51-TT	378	510
BEC-0520-51-VV	378	510
BEC-0520-51-YY	378	415

Finishes:

CC = chrome, CD = chrome diamond, CF = smokey chrome, KK = matte black, LL = satin brass, BB = white, NN = brushed nickel, YY = polished nickel, TT = venetian bronze, VV = satin copper, GG = gold, KM = black titanium, CB = chrome white, KB = matte black white, LB = satin brass white, NB = brushed nickel white, YB = polished nickel white, TB = venetian bronze, VB = satin copper white, GB = gold white

PRICE INDEX

CODE	PAGE	PRICE
BEC-0520-73-BB	378	252
BEC-0520-73-CC	378	168
BEC-0520-73-GG	378	370
BEC-0520-73-KK	378	218
BEC-0520-73-KM	378	269
BEC-0520-73-LL	378	252
BEC-0520-73-NN	378	218
BEC-0520-73-TT	378	269
BEC-0520-73-VV	378	269
BEC-0520-73-YY	378	218
BEC-0520-74-BB	378	297
BEC-0520-74-CC	378	198
BEC-0520-74-GG	378	436
BEC-0520-74-KK	378	257
BEC-0520-74-LL	378	297
BEC-0520-74-NN	378	257
BEC-0520-74-TT	378	317
BEC-0520-74-VV	378	317
BEC-0520-74-YY	378	257
BEC-0520-83-BB	378	297
BEC-0520-83-CC	378	198
BEC-0520-83-GG	378	436
BEC-0520-83-KK	378	257
BEC-0520-83-LL	378	297
BEC-0520-83-NN	378	257
BEC-0520-83-TT	378	317
BEC-0520-83-VV	378	317
BEC-0520-83-YY	378	257
BEC-0520-84-BB	379	342
BEC-0520-84-CC	379	228
BEC-0520-84-GG	379	502
BEC-0520-84-KK	379	296
BEC-0520-84-LL	379	342
BEC-0520-84-NN	379	296
BEC-0520-84-TT	379	365
BEC-0520-84-VV	379	365
BEC-0520-84-YY	379	296
BGL-1670-00-BB	357	937
BGL-1670-00-CC	357	625
BGL-1670-00-GG	357	1374
BGL-1670-00-KK	357	812
BGL-1670-00-LL	357	937
BGL-1670-00-NN	357	812
BGL-1670-00-TT	357	999
BGL-1670-00-VV	357	999
BGL-1670-00-YY	357	812
BGL-2070-50-BB	357	802
BGL-2070-50-CC	357	535
BGL-2070-50-GG	357	1176
BGL-2070-50-KK	357	695
BGL-2070-50-LL	357	802
BGL-2070-50-NN	357	695
BGL-2070-50-TT	357	855
BGL-2070-50-VV	357	855
BGL-2070-50-YY	357	695
BGL-2160-00-BB	357	1077
BGL-2160-00-CC	357	718
BGL-2160-00-GG	357	1580

CODE	PAGE	PRICE
BGL-2160-00-KK	357	933
BGL-2160-00-LL	357	1077
BGL-2160-00-NN	357	933
BGL-2160-00-TT	357	1149
BGL-2160-00-VV	357	1149
BGL-2160-00-YY	357	933
BGL-2175-50-BB	357	632
BGL-2175-50-CC	357	421
BGL-2175-50-GG	357	927
BGL-2175-50-KK	357	547
BGL-2175-50-LL	357	632
BGL-2175-50-NN	357	547
BGL-2175-50-TT	357	674
BGL-2175-50-VV	357	674
BGL-2175-50-YY	357	547
BGL-2175-70-BB	358	607
BGL-2175-70-CC	358	404
BGL-2175-70-GG	358	889
BGL-2175-70-KK	358	526
BGL-2175-70-LL	358	607
BGL-2175-70-NN	358	526
BGL-2175-70-TT	358	646
BGL-2175-70-VV	358	646
BGL-2175-70-YY	358	526
BGL-2175-90-BB	358	734
BGL-2175-90-CC	358	489
BGL-2175-90-GG	358	1076
BGL-2175-90-KK	358	635
BGL-2175-90-LL	358	734
BGL-2175-90-NN	358	635
BGL-2175-90-TT	358	782
BGL-2175-90-VV	358	782
BGL-2175-90-YY	358	635
BGL-2580-50-BB	358	802
BGL-2580-50-CC	358	535
BGL-2580-50-GG	358	1176
BGL-2580-50-KK	358	695
BGL-2580-50-LL	358	802
BGL-2580-50-NN	358	695
BGL-2580-50-TT	358	855
BGL-2580-50-VV	358	855
BGL-2580-50-YY	358	695
BGL-3070-50-BB	358	850
BGL-3070-50-CC	358	566
BGL-3070-50-GG	358	1246
BGL-3070-50-KK	358	736
BGL-3070-50-LL	358	850
BGL-3070-50-NN	358	736
BGL-3070-50-TT	358	905
BGL-3070-50-VV	358	905
BGL-3070-50-YY	358	736
BGL-3080-50-BB	359	1012
BGL-3080-50-CC	359	674
BGL-3080-50-GG	359	1483
BGL-3080-50-KK	359	877
BGL-3080-50-LL	359	1012
BGL-3080-50-NN	359	877
BGL-3080-50-TT	359	1078

CODE	PAGE	PRICE
BGL-3080-50-VV	359	1078
BGL-3080-50-YY	359	877
BGL-3097-50-BB	359	1349
BGL-3097-50-CC	359	899
BGL-3097-50-GG	359	1978
BGL-3097-50-KK	359	1169
BGL-3097-50-LL	359	1349
BGL-3097-50-NN	359	1169
BGL-3097-50-TT	359	1438
BGL-3097-50-VV	359	1438
BGL-3097-50-YY	359	1169
BGL-4880-00-BB	359	1147
BGL-4880-00-CC	359	764
BGL-4880-00-GG	359	1681
BGL-4880-00-KK	359	994
BGL-4880-00-LL	359	1147
BGL-4880-00-NN	359	994
BGL-4880-00-TT	359	1222
BGL-4880-00-VV	359	1222
BGL-4880-00-YY	359	994
BOD-5001-00-BB	380	209
BOD-5001-00-CC	380	139
BOD-5001-00-GG	380	306
BOD-5001-00-KK	380	181
BOD-5001-00-LL	380	209
BOD-5001-00-NN	380	181
BOD-5001-00-TT	380	222
BOD-5001-00-VV	380	222
BOD-5001-00-YY	380	181
BOD-5002-01-BB	380	299
BOD-5002-01-CC	380	199
BOD-5002-01-GG	380	438
BOD-5002-01-KK	380	259
BOD-5002-01-LL	380	299
BOD-5002-01-NN	380	259
BOD-5002-01-TT	380	318
BOD-5002-01-VV	380	318
BOD-5002-01-YY	380	259
BOD-5004-02-BB	380	372
BOD-5004-02-CC	380	248
BOD-5004-02-GG	380	546
BOD-5004-02-KK	380	322
BOD-5004-02-LL	380	372
BOD-5004-02-NN	380	322
BOD-5004-02-TT	380	397
BOD-5004-02-VV	380	397
BOD-5004-02-YY	380	322
BOD-5006-01-BB	380	525
BOD-5006-01-CC	380	350
BOD-5006-01-GG	380	770
BOD-5006-01-KK	380	455
BOD-5006-01-LL	380	525
BOD-5006-01-NN	380	455
BOD-5006-01-TT	380	560
BOD-5006-01-VV	380	560
BOD-5006-01-YY	380	455
BOD-5007-01-BB	380	488
BOD-5007-01-CC	380	325

Actual products may differ from pictures. Actual products measures may differ from the measures shown. All USD prices are subject to change without notice. Effective as of August 2023.

PRICE INDEX

CODE	PAGE	PRICE
BOD-5007-01-GG	380	715
BOD-5007-01-KK	380	423
BOD-5007-01-LL	380	488
BOD-5007-01-NN	380	423
BOD-5007-01-TT	380	520
BOD-5007-01-VV	380	520
BOD-5007-01-YY	380	423
BOY-2012-01-CC	364	150
BOY-2012-01-NN	364	195
BOY-2700-00-BB	364	180
BOY-2700-00-CC	364	120
BOY-2700-00-GG	364	264
BOY-2700-00-II	364	180
BOY-2700-00-KK	364	156
BOY-2700-00-KM	364	192
BOY-2700-00-LL	364	180
BOY-2700-00-NN	364	156
BOY-2700-00-TT	364	192
BOY-2700-00-VV	364	192
BOY-2700-00-YY	364	156
BOY-2800-00-CC	364	120
BOY-2800-00-KK	364	156
BRA-0612-02-BB	372	92
BRA-0612-02-CC	372	61
BRA-0612-02-GG	372	134
BRA-0612-02-KK	372	79
BRA-0612-02-LL	372	92
BRA-0612-02-NN	372	79
BRA-0612-02-TT	372	98
BRA-0612-02-VV	372	98
BRA-0612-02-YY	372	79
BRA-0612-14-BB	372	137
BRA-0612-14-CC	372	91
BRA-0612-14-GG	372	200
BRA-0612-14-KK	372	118
BRA-0612-14-LL	372	137
BRA-0612-14-NN	372	118
BRA-0612-14-TT	372	146
BRA-0612-14-VV	372	146
BRA-0612-14-YY	372	118
BRA-1212-02-BB	372	186
BRA-1212-02-CC	372	124
BRA-1212-02-GG	372	273
BRA-1212-02-KK	372	161
BRA-1212-02-LL	372	186
BRA-1212-02-NN	372	161
BRA-1212-02-TT	372	198
BRA-1212-02-VV	372	198
BRA-1212-02-YY	372	161
BRA-1212-14-BB	372	231
BRA-1212-14-CC	372	154
BRA-1212-14-GG	372	339
BRA-1212-14-KK	372	200
BRA-1212-14-LL	372	231
BRA-1212-14-NN	372	200
BRA-1212-14-TT	372	246
BRA-1212-14-VV	372	246
BRA-1212-14-YY	372	200

CODE	PAGE	PRICE
BRA-1409-02-BB	372	471
BRA-1409-02-CC	372	314
BRA-1409-02-GG	372	691
BRA-1409-02-KK	372	408
BRA-1409-02-LL	372	471
BRA-1409-02-NN	372	408
BRA-1409-02-TT	372	502
BRA-1409-02-VV	372	502
BRA-1409-02-YY	372	408
BRA-1608-00-BB	373	552
BRA-1608-00-CC	373	368
BRA-1608-00-GG	373	810
BRA-1608-00-KK	373	478
BRA-1608-00-LL	373	552
BRA-1608-00-NN	373	478
BRA-1608-00-TT	373	589
BRA-1608-00-VV	373	589
BRA-1608-00-YY	373	478
BRA-1612-44-BB	373	299
BRA-1612-44-CC	373	199
BRA-1612-44-GG	373	438
BRA-1612-44-KK	373	259
BRA-1612-44-LL	373	299
BRA-1612-44-NN	373	259
BRA-1612-44-TT	373	318
BRA-1612-44-VV	373	318
BRA-1612-44-YY	373	259
BRA-1612-66-BB	373	269
BRA-1612-66-CC	373	179
BRA-1612-66-GG	373	394
BRA-1612-66-KK	373	233
BRA-1612-66-KM	373	286
BRA-1612-66-LL	373	269
BRA-1612-66-NN	373	233
BRA-1612-66-TT	373	286
BRA-1612-66-VV	373	286
BRA-1612-66-YY	373	233
BRA-1614-04-BB	373	486
BRA-1614-04-CC	373	324
BRA-1614-04-GG	373	713
BRA-1614-04-KK	373	421
BRA-1614-04-LL	373	486
BRA-1614-04-NN	373	421
BRA-1614-04-TT	373	518
BRA-1614-04-VV	373	518
BRA-1614-04-YY	373	421
BRA-1812-02-BB	373	252
BRA-1812-02-CC	373	168
BRA-1812-02-GG	373	370
BRA-1812-02-KK	373	218
BRA-1812-02-LL	373	252
BRA-1812-02-NN	373	218
BRA-1812-02-TT	373	269
BRA-1812-02-VV	373	269
BRA-1812-02-YY	373	218
BRA-1812-14-BB	374	282
BRA-1812-14-CC	374	188
BRA-1812-14-GG	374	414

CODE	PAGE	PRICE
BRA-1812-14-KK	374	244
BRA-1812-14-LL	374	282
BRA-1812-14-NN	374	244
BRA-1812-14-TT	374	301
BRA-1812-14-VV	374	301
BRA-1812-14-YY	374	244
BRA-1815-02-BB	374	488
BRA-1815-02-CC	374	325
BRA-1815-02-GG	374	715
BRA-1815-02-KK	374	423
BRA-1815-02-LL	374	488
BRA-1815-02-NN	374	423
BRA-1815-02-TT	374	520
BRA-1815-02-VV	374	520
BRA-1815-02-YY	374	423
BRA-1816-02-BB	374	338
BRA-1816-02-CC	374	225
BRA-1816-02-GG	374	495
BRA-1816-02-KK	374	293
BRA-1816-02-LL	374	338
BRA-1816-02-NN	374	293
BRA-1816-02-TT	374	360
BRA-1816-02-VV	374	360
BRA-1816-02-YY	374	293
CAC-6023-01-BB	60	63
CAC-6023-01-CC	60	42
CAC-6023-01-GG	60	92
CAC-6023-01-KK	60	55
CAC-6023-01-LL	60	63
CAC-6023-01-TT	60	67
CAC-6023-01-VV	60	67
CAC-6023-01-YY	60	55
COL-3004-03-BB	308	1418
COL-3004-03-CC	308	945
COL-3004-03-GG	308	2079
COL-3004-03-KK	308	1229
COL-3004-03-LL	308	1418
COL-3004-03-NN	308	1229
COL-3004-03-TT	308	1512
COL-3004-03-VV	308	1512
COL-3004-03-YY	308	1229
CUI-1940-02L-CC	50	1266
CUI-1940-02L-KK	50	1646
CUI-1940-02L-SS	50	1646
CUI-2030-02L-CC	50	553
CUI-2030-02L-SS	50	719
CUI-2040-02L-BB	50	892
CUI-2040-02L-CC	50	595
CUI-2040-02L-GG	50	1309
CUI-2040-02L-KK	50	773
CUI-2040-02L-LL	50	892
CUI-2040-02L-SS	50	773
CUI-2040-02L-TT	50	952
CUI-2040-02L-VV	50	952
CUI-2040-02L-YY	50	773
CUI-2040-35L-BB	51	968
CUI-2040-35L-CC	51	645
CUI-2040-35L-GG	51	1419

Finishes:

CC = chrome, CD = chrome diamond, CF = smokey chrome, KK = matte black, LL = satin brass, BB = white, NN = brushed nickel, YY = polished nickel, TT = venetian bronze, VV = satin copper, GG = gold, KM = black titanium, CB = chrome white, KB = matte black white, LB = satin brass white, NB = brushed nickel white, YB = polished nickel white, TB = venetian bronze, VB = satin copper white, GB = gold white

PRICE INDEX

CODE	PAGE	PRICE
CUI-2040-35L-KK	51	839
CUI-2040-35L-LL	51	968
CUI-2040-35L-SS	51	839
CUI-2040-35L-TT	51	1032
CUI-2040-35L-VV	51	1032
CUI-2040-35L-YY	51	839
CUI-4093-00L-BB	57	594
CUI-4093-00L-CC	57	396
CUI-4093-00L-GG	57	871
CUI-4093-00L-KK	57	515
CUI-4093-00L-KM	57	634
CUI-4093-00L-LL	57	594
CUI-4093-00L-SS	57	515
CUI-4093-00L-TT	57	634
CUI-4093-00L-VV	57	634
CUI-4093-00L-YY	57	515
CUI-4095-00L-BB	58	564
CUI-4095-00L-CC	58	376
CUI-4095-00L-GG	58	827
CUI-4095-00L-KK	58	489
CUI-4095-00L-LL	58	564
CUI-4095-00L-SS	58	489
CUI-4095-00L-TT	58	602
CUI-4095-00L-VV	58	602
CUI-4095-00L-YY	58	489
CUI-4293-00L-BB	58	1568
CUI-4293-00L-CC	58	1045
CUI-4293-00L-GG	58	2299
CUI-4293-00L-KK	58	1359
CUI-4293-00L-KM	58	1672
CUI-4293-00L-LL	58	1568
CUI-4293-00L-SS	58	1359
CUI-4293-00L-TT	58	1672
CUI-4293-00L-VV	58	1672
CUI-4293-00L-YY	58	1359
CUI-4295-00L-BB	58	1463
CUI-4295-00L-CC	58	975
CUI-4295-00L-GG	58	2145
CUI-4295-00L-KK	58	1268
CUI-4295-00L-LL	58	1463
CUI-4295-00L-SS	58	1268
CUI-4295-00L-TT	58	1560
CUI-4295-00L-VV	58	1560
CUI-4295-00L-YY	58	1268
CUI-9181-47L-CC	51	843
CUI-9181-47L-SS	51	1096
CUI-9245-02L-BB	51	1493
CUI-9245-02L-CC	51	995
CUI-9245-02L-GG	51	2189
CUI-9245-02L-KK	51	1294
CUI-9245-02L-LL	51	1493
CUI-9245-02L-SS	51	1294
CUI-9245-02L-TT	51	1592
CUI-9245-02L-VV	51	1592
CUI-9245-02L-YY	51	1294
CUI-9246-02L-KL	52	1584
CUI-9246-02L-LK	52	1584
CUI-9246-02L-SK	52	1368

CODE	PAGE	PRICE
CUI-9247-02L-BB	52	1388
CUI-9247-02L-CC	52	925
CUI-9247-02L-GG	52	2035
CUI-9247-02L-KK	52	1203
CUI-9247-02L-LL	52	1388
CUI-9247-02L-SS	52	1203
CUI-9247-02L-TT	52	1480
CUI-9247-02L-VV	52	1480
CUI-9247-02L-YY	52	1203
CUI-9248-02L-KL	52	1584
CUI-9248-02L-SK	52	1368
CUI-9249-12L-CC	53	1304
CUI-9249-12L-CK	53	1304
CUI-9249-12L-KK	53	1696
CUI-9249-12L-KL	53	1696
CUI-9249-12L-LK	53	1956
CUI-9249-12L-LL	53	1956
CUI-9249-12L-SK	53	1696
CUI-9249-12L-SS	53	1696
CUI-9249-22L-CC	53	1356
CUI-9249-22L-CK	53	1356
CUI-9249-22L-KK	53	1762
CUI-9249-22L-KL	53	1762
CUI-9249-22L-LK	53	2034
CUI-9249-22L-LL	53	2034
CUI-9249-22L-SK	53	1762
CUI-9249-22L-SS	53	1762
CUI-9249-32L-CC	53	1253
CUI-9249-32L-CK	53	1253
CUI-9249-32L-KK	53	1629
CUI-9249-32L-KL	53	1629
CUI-9249-32L-LK	53	1879
CUI-9249-32L-LL	53	1879
CUI-9249-32L-SK	53	1629
CUI-9249-32L-SS	53	1629
CUI-9250-12L-CC	54	1304
CUI-9250-12L-CK	54	1304
CUI-9250-12L-KK	54	1696
CUI-9250-12L-KL	54	1696
CUI-9250-12L-LK	54	1956
CUI-9250-12L-LL	54	1956
CUI-9250-12L-SK	54	1696
CUI-9250-12L-SS	54	1696
CUI-9250-22L-CC	54	1356
CUI-9250-22L-CK	54	1356
CUI-9250-22L-KK	54	1762
CUI-9250-22L-KL	54	1762
CUI-9250-22L-LK	54	2034
CUI-9250-22L-LL	54	2034
CUI-9250-22L-SK	54	1762
CUI-9250-22L-SS	54	1762
CUI-9250-32L-CC	54	1253
CUI-9250-32L-CK	54	1253
CUI-9250-32L-KK	54	1629
CUI-9250-32L-KL	54	1629
CUI-9250-32L-LK	54	1879
CUI-9250-32L-LL	54	1879
CUI-9250-32L-SK	54	1629

CODE	PAGE	PRICE
CUI-9250-32L-SS	54	1629
CUI-9335-02L-BB	55	1881
CUI-9335-02L-CC	55	1254
CUI-9335-02L-GG	55	2759
CUI-9335-02L-KK	55	1630
CUI-9335-02L-KM	55	2006
CUI-9335-02L-LL	55	1881
CUI-9335-02L-SS	55	1630
CUI-9335-02L-TT	55	2006
CUI-9335-02L-VV	55	2006
CUI-9335-02L-YY	55	1630
CUI-9340-02L-BB	55	1493
CUI-9340-02L-CC	55	995
CUI-9340-02L-GG	55	2189
CUI-9340-02L-KK	55	1294
CUI-9340-02L-KM	55	1592
CUI-9340-02L-LL	55	1493
CUI-9340-02L-SS	55	1294
CUI-9340-02L-TT	55	1592
CUI-9340-02L-VV	55	1592
CUI-9340-02L-YY	55	1294
CUI-9345-02L-BB	55	1388
CUI-9345-02L-CC	55	925
CUI-9345-02L-GG	55	2035
CUI-9345-02L-KK	55	1203
CUI-9345-02L-KM	55	1480
CUI-9345-02L-LL	55	1388
CUI-9345-02L-SS	55	1203
CUI-9345-02L-TT	55	1480
CUI-9345-02L-VV	55	1480
CUI-9345-02L-YY	55	1203
CUI-9350-02L-BB	56	1718
CUI-9350-02L-CC	56	1145
CUI-9350-02L-GG	56	2519
CUI-9350-02L-KK	56	1489
CUI-9350-02L-LL	56	1718
CUI-9350-02L-SS	56	1489
CUI-9350-02L-TT	56	1832
CUI-9350-02L-VV	56	1832
CUI-9350-02L-YY	56	1489
CUI-9352-02L-BB	56	1643
CUI-9352-02L-CC	56	1095
CUI-9352-02L-GG	56	2409
CUI-9352-02L-KK	56	1424
CUI-9352-02L-LL	56	1643
CUI-9352-02L-SS	56	1424
CUI-9352-02L-TT	56	1752
CUI-9352-02L-VV	56	1752
CUI-9352-02L-YY	56	1424
CUI-9355-02L-BB	56	1718
CUI-9355-02L-CC	56	1145
CUI-9355-02L-GG	56	2519
CUI-9355-02L-KK	56	1489
CUI-9355-02L-LL	56	1718
CUI-9355-02L-SS	56	1489
CUI-9355-02L-TT	56	1832
CUI-9355-02L-VV	56	1832
CUI-9355-02L-YY	56	1489

Actual products may differ from pictures. Actual products measures may differ from the measures shown. All USD prices are subject to change without notice. Effective as of August 2023.

PRICE INDEX

CODE	PAGE	PRICE
CUI-9380-02L-CC	57	1277
CUI-9380-02L-SS	57	1659
CUI-9540-35L-BB	57	1115
CUI-9540-35L-CC	57	744
CUI-9540-35L-GG	57	1636
CUI-9540-35L-KK	57	967
CUI-9540-35L-LL	57	1115
CUI-9540-35L-SS	57	967
CUI-9540-35L-TT	57	1190
CUI-9540-35L-VV	57	1190
CUI-9540-35L-YY	57	967
DGL-1670-03-BB	351	1041
DGL-1670-03-CC	351	694
DGL-1670-03-GG	351	1527
DGL-1670-03-KK	351	902
DGL-1670-03-LL	351	1041
DGL-1670-03-NN	351	902
DGL-1670-03-TT	351	1110
DGL-1670-03-VV	351	1110
DGL-1670-03-YY	351	902
DGL-2070-51-BB	351	1019
DGL-2070-51-CC	351	679
DGL-2070-51-GG	351	1494
DGL-2070-51-KK	351	883
DGL-2070-51-LL	351	1019
DGL-2070-51-NN	351	883
DGL-2070-51-TT	351	1086
DGL-2070-51-VV	351	1086
DGL-2070-51-YY	351	883
DGL-2070-53-BB	351	822
DGL-2070-53-CC	351	548
DGL-2070-53-GG	351	1206
DGL-2070-53-KK	351	712
DGL-2070-53-LL	351	822
DGL-2070-53-NN	351	712
DGL-2070-53-TT	351	877
DGL-2070-53-VV	351	877
DGL-2070-53-YY	351	712
DGL-2070-57-BB	352	891
DGL-2070-57-CC	352	594
DGL-2070-57-GG	352	1307
DGL-2070-57-KK	352	772
DGL-2070-57-LL	352	891
DGL-2070-57-NN	352	772
DGL-2070-57-TT	352	950
DGL-2070-57-VV	352	950
DGL-2070-57-YY	352	772
DGL-2070-62-BB	352	1197
DGL-2070-62-CC	352	798
DGL-2070-62-CI	352	958
DGL-2070-62-CK	352	958
DGL-2070-62-GG	352	1756
DGL-2070-62-KI	352	1080
DGL-2070-62-KK	352	1037
DGL-2070-62-LL	352	1197
DGL-2070-62-NN	352	1037
DGL-2070-62-TT	352	1277
DGL-2070-62-VV	352	1277

CODE	PAGE	PRICE
DGL-2070-62-YY	352	1037
DGL-2160-04-BB	352	1197
DGL-2160-04-CC	352	798
DGL-2160-04-GG	352	1756
DGL-2160-04-KK	352	1037
DGL-2160-04-LL	352	1197
DGL-2160-04-NN	352	1037
DGL-2160-04-TT	352	1277
DGL-2160-04-VV	352	1277
DGL-2160-04-YY	352	1037
DGL-2170-63-BB	353	674
DGL-2170-63-CC	353	449
DGL-2170-63-GG	353	988
DGL-2170-63-KK	353	584
DGL-2170-63-LL	353	674
DGL-2170-63-NN	353	584
DGL-2170-63-TT	353	718
DGL-2170-63-VV	353	718
DGL-2170-63-YY	353	584
DGL-2175-52-BB	353	815
DGL-2175-52-CC	353	543
DGL-2175-52-GG	353	1195
DGL-2175-52-KK	353	706
DGL-2175-52-LL	353	815
DGL-2175-52-NN	353	706
DGL-2175-52-TT	353	869
DGL-2175-52-VV	353	869
DGL-2175-52-YY	353	706
DGL-2175-53-BB	353	702
DGL-2175-53-CC	353	468
DGL-2175-53-GG	353	1030
DGL-2175-53-KK	353	608
DGL-2175-53-LL	353	702
DGL-2175-53-NN	353	608
DGL-2175-53-TT	353	749
DGL-2175-53-VV	353	749
DGL-2175-53-YY	353	608
DGL-2580-53-BB	354	891
DGL-2580-53-CC	354	594
DGL-2580-53-GG	354	1307
DGL-2580-53-KK	354	772
DGL-2580-53-LL	354	891
DGL-2580-53-NN	354	772
DGL-2580-53-TT	354	950
DGL-2580-53-VV	354	950
DGL-2580-53-YY	354	772
DGL-2584-53-BB	354	906
DGL-2584-53-CC	354	604
DGL-2584-53-GG	354	1329
DGL-2584-53-KK	354	785
DGL-2584-53-KM	354	966
DGL-2584-53-LL	354	906
DGL-2584-53-NN	354	785
DGL-2584-53-TT	354	966
DGL-2584-53-VV	354	966
DGL-2584-53-YY	354	785
DGL-3070-53-BB	354	944
DGL-3070-53-CC	354	629

CODE	PAGE	PRICE
DGL-3070-53-GG	354	1384
DGL-3070-53-KK	354	818
DGL-3070-53-LL	354	944
DGL-3070-53-NN	354	818
DGL-3070-53-TT	354	1006
DGL-3070-53-VV	354	1006
DGL-3070-53-YY	354	818
DGL-3080-73-BB	355	1124
DGL-3080-73-CC	355	749
DGL-3080-73-GG	355	1648
DGL-3080-73-KK	355	974
DGL-3080-73-LL	355	1124
DGL-3080-73-NN	355	974
DGL-3080-73-TT	355	1198
DGL-3080-73-VV	355	1198
DGL-3080-73-YY	355	974
DGL-3080-83-BB	355	1139
DGL-3080-83-CC	355	759
DGL-3080-83-GG	355	1670
DGL-3080-83-KK	355	987
DGL-3080-83-LL	355	1139
DGL-3080-83-NN	355	987
DGL-3080-83-TT	355	1214
DGL-3080-83-VV	355	1214
DGL-3080-83-YY	355	987
DGL-3097-73-BB	355	1499
DGL-3097-73-CC	355	999
DGL-3097-73-GG	355	2198
DGL-3097-73-KK	355	1299
DGL-3097-73-LL	355	1499
DGL-3097-73-NN	355	1299
DGL-3097-73-TT	355	1598
DGL-3097-73-VV	355	1598
DGL-3097-73-YY	355	1299
DGL-4880-03-BB	356	1274
DGL-4880-03-CC	356	849
DGL-4880-03-GG	356	1868
DGL-4880-03-KK	356	1104
DGL-4880-03-LL	356	1274
DGL-4880-03-NN	356	1104
DGL-4880-03-TT	356	1358
DGL-4880-03-VV	356	1358
DGL-4880-03-YY	356	1104
DIS-9030-00-BB	60	225
DIS-9030-00-CC	60	150
DIS-9030-00-GG	60	330
DIS-9030-00-KK	60	195
DIS-9030-00-KM	60	240
DIS-9030-00-LL	60	225
DIS-9030-00-SS	60	195
DIS-9030-00-TT	60	240
DIS-9030-00-VV	60	240
DIS-9030-00-YY	60	195
DIS-9035-00-BB	60	363
DIS-9035-00-CC	60	242
DIS-9035-00-GG	60	532
DIS-9035-00-KK	60	314
DIS-9035-00-LL	60	363

Finishes:

CC = chrome, CD = chrome diamond, CF = smokey chrome, KK = matte black, LL = satin brass, BB = white, NN = brushed nickel, YY = polished nickel, TT = venetian bronze, VV = satin copper, GG = gold, KM = black titanium, CB = chrome white, KB = matte black white, LB = satin brass white, NB = brushed nickel white, YB = polished nickel white, TB = venetian bronze, VB = satin copper white, GB = gold white

PRICE INDEX

CODE	PAGE	PRICE
DIS-9035-00-SS	60	314
DIS-9035-00-TT	60	387
DIS-9035-00-VV	60	387
DIS-9035-00-YY	60	314
DIS-9040-00-BB	60	210
DIS-9040-00-CC	60	140
DIS-9040-00-GG	60	308
DIS-9040-00-KK	60	182
DIS-9040-00-KM	60	224
DIS-9040-00-LL	60	210
DIS-9040-00-SS	60	182
DIS-9040-00-TT	60	224
DIS-9040-00-VV	60	224
DIS-9040-00-YY	60	182
DOU-1219-01-BB	360	194
DOU-1219-01-CC	360	129
DOU-1219-01-GG	360	284
DOU-1219-01-KK	360	168
DOU-1219-01-LL	360	194
DOU-1219-01-NN	360	168
DOU-1219-01-TT	360	206
DOU-1219-01-VV	360	206
DOU-1219-01-YY	360	168
DOU-1455-02-BB	360	351
DOU-1455-02-CC	360	234
DOU-1455-02-GG	360	515
DOU-1455-02-KK	360	304
DOU-1455-02-LL	360	351
DOU-1455-02-NN	360	304
DOU-1455-02-TT	360	374
DOU-1455-02-VV	360	374
DOU-1455-02-YY	360	304
DOU-2515-04-BB	360	599
DOU-2515-04-CC	360	399
DOU-2515-04-GG	360	878
DOU-2515-04-KK	360	519
DOU-2515-04-LL	360	599
DOU-2515-04-NN	360	519
DOU-2515-04-TT	360	639
DOU-2515-04-VV	360	639
DOU-2515-04-YY	360	519
DOU-2535-04-BB	360	594
DOU-2535-04-CC	360	396
DOU-2535-04-GG	360	871
DOU-2535-04-KK	360	515
DOU-2535-04-LL	360	594
DOU-2535-04-NN	360	515
DOU-2535-04-TT	360	634
DOU-2535-04-VV	360	634
DOU-2535-04-YY	360	515
DOU-2550-01-BB	361	297
DOU-2550-01-CC	361	198
DOU-2550-01-GG	361	436
DOU-2550-01-KK	361	257
DOU-2550-01-LL	361	297
DOU-2550-01-NN	361	257
DOU-2550-01-TT	361	317
DOU-2550-01-VV	361	317

CODE	PAGE	PRICE
DOU-2550-01-YY	361	257
DOU-2551-03-BB	361	186
DOU-2551-03-CC	361	124
DOU-2551-03-GG	361	273
DOU-2551-03-KK	361	161
DOU-2551-03-LL	361	186
DOU-2551-03-NN	361	161
DOU-2551-03-TT	361	198
DOU-2551-03-VV	361	198
DOU-2551-03-YY	361	161
DOU-2553-04-BB	361	428
DOU-2553-04-CC	361	285
DOU-2553-04-GG	361	627
DOU-2553-04-KK	361	371
DOU-2553-04-LL	361	428
DOU-2553-04-NN	361	371
DOU-2553-04-TT	361	456
DOU-2553-04-VV	361	456
DOU-2553-04-YY	361	371
DOU-2555-01-BB	361	141
DOU-2555-01-CC	361	94
DOU-2555-01-GG	361	207
DOU-2555-01-KK	361	122
DOU-2555-01-LL	361	141
DOU-2555-01-NN	361	122
DOU-2555-01-TT	361	150
DOU-2555-01-VV	361	150
DOU-2555-01-YY	361	122
DOU-2561-01-CC	362	75
DOU-2561-01-KK	362	98
DOU-2566-03-BB	362	194
DOU-2566-03-CC	362	129
DOU-2566-03-GG	362	284
DOU-2566-03-KK	362	168
DOU-2566-03-LL	362	194
DOU-2566-03-NN	362	168
DOU-2566-03-TT	362	206
DOU-2566-03-VV	362	206
DOU-2566-03-YY	362	168
DOU-2574-03-BB	362	258
DOU-2574-03-CC	362	172
DOU-2574-03-GG	362	378
DOU-2574-03-KK	362	224
DOU-2574-03-LL	362	258
DOU-2574-03-NN	362	224
DOU-2574-03-TT	362	275
DOU-2574-03-VV	362	275
DOU-2574-03-YY	362	224
DOU-2584-03-BB	362	273
DOU-2584-03-CC	362	182
DOU-2584-03-GG	362	400
DOU-2584-03-KK	362	237
DOU-2584-03-KM	362	291
DOU-2584-03-LL	362	273
DOU-2584-03-NN	362	237
DOU-2584-03-TT	362	291
DOU-2584-03-VV	362	291
DOU-2584-03-YY	362	237

CODE	PAGE	PRICE
DOU-2604-01-BB	363	297
DOU-2604-01-CC	363	198
DOU-2604-01-GG	363	436
DOU-2604-01-KK	363	257
DOU-2604-01-KM	363	317
DOU-2604-01-LL	363	297
DOU-2604-01-NN	363	257
DOU-2604-01-TT	363	317
DOU-2604-01-VV	363	317
DOU-2604-01-YY	363	257
DOU-2635-02-BB	363	360
DOU-2635-02-CC	363	240
DOU-2635-02-GG	363	528
DOU-2635-02-II	363	316
DOU-2635-02-KK	363	312
DOU-2635-02-LL	363	360
DOU-2635-02-NN	363	312
DOU-2635-02-TT	363	384
DOU-2635-02-VV	363	384
DOU-2635-02-YY	363	312
DOU-2652-01-CF	363	209
DOU-6030-M2-BB	61	339
DOU-6030-M2-CC	61	226
DOU-6030-M2-GG	61	497
DOU-6030-M2-KK	61	294
DOU-6030-M2-KM	61	361
DOU-6030-M2-LL	61	339
DOU-6030-M2-SS	61	294
DOU-6030-M2-TT	61	361
DOU-6030-M2-VV	61	361
DOU-6030-M2-YY	61	294
DOU-6033-02-BB	61	311
DOU-6033-02-CC	61	208
DOU-6033-02-GG	61	457
DOU-6033-02-KK	61	270
DOU-6033-02-LL	61	311
DOU-6033-02-SS	61	270
DOU-6033-02-TT	61	332
DOU-6033-02-VV	61	332
DOU-6033-02-YY	61	270
DOU-6033-M2-BB	61	390
DOU-6033-M2-CC	61	260
DOU-6033-M2-GG	61	572
DOU-6033-M2-KK	61	338
DOU-6033-M2-KM	61	416
DOU-6033-M2-LL	61	390
DOU-6033-M2-SS	61	338
DOU-6033-M2-TT	61	416
DOU-6033-M2-VV	61	416
DOU-6033-M2-YY	61	338
DOU-6035-02-BB	61	311
DOU-6035-02-CC	61	208
DOU-6035-02-GG	61	457
DOU-6035-02-KK	61	270
DOU-6035-02-LL	61	311
DOU-6035-02-SS	61	270
DOU-6035-02-TT	61	332
DOU-6035-02-VV	61	332

Actual products may differ from pictures. Actual products measures may differ from the measures shown. All USD prices are subject to change without notice. Effective as of August 2023.

PRICE INDEX

CODE	PAGE	PRICE
DOU-6035-02-YY	61	270
DOU-6037-02-BB	62	416
DOU-6037-02-CC	62	277
DOU-6037-02-GG	62	610
DOU-6037-02-KK	62	360
DOU-6037-02-LL	62	416
DOU-6037-02-SS	62	360
DOU-6037-02-TT	62	443
DOU-6037-02-VV	62	443
DOU-6037-02-YY	62	360
DOU-6038-M2-CC	62	277
DOU-6038-M2-KK	62	360
DOU-6038-M2-LL	62	416
DOU-6038-M2-SS	62	360
DOU-6039-M2-CC	62	277
DOU-6039-M2-KK	62	360
DOU-6039-M2-LL	62	416
DOU-6039-M2-SS	62	360
DOU-6047-03-BB	62	164
DOU-6047-03-CC	62	109
DOU-6047-03-GG	62	240
DOU-6047-03-KK	62	142
DOU-6047-03-LL	62	164
DOU-6047-03-SS	62	142
DOU-6047-03-TT	62	174
DOU-6047-03-VV	62	174
DOU-6047-03-YY	62	142
DOU-6070-02-CC	62	109
DOU-6070-02-GG	62	240
DOU-6070-02-KK	62	142
DOU-6070-02-LL	62	164
DOU-6070-02-SS	62	142
DOU-6070-02-TT	62	174
DOU-6070-02-VV	62	174
DOU-6070-02-YY	62	142
DOU-6071-02-BB	63	164
DOU-6071-02-CC	63	109
DOU-6071-02-GG	63	240
DOU-6071-02-KK	63	142
DOU-6071-02-LL	63	164
DOU-6071-02-SS	63	142
DOU-6071-02-TT	63	174
DOU-6071-02-VV	63	174
DOU-6071-02-YY	63	142
DSP-2555-20-BB	348	654
DSP-2555-20-CC	348	436
DSP-2555-20-GG	348	959
DSP-2555-20-KK	348	567
DSP-2555-20-LL	348	654
DSP-2555-20-NN	348	567
DSP-2555-20-TT	348	697
DSP-2555-20-VV	348	697
DSP-2555-20-YY	348	567
DSP-2561-19-CC	348	369
DSP-2561-19-KK	348	480
DSP-2566-19-BB	348	635
DSP-2566-19-CC	348	423
DSP-2566-19-GG	348	931

CODE	PAGE	PRICE
DSP-2566-19-KK	348	550
DSP-2566-19-LL	348	635
DSP-2566-19-NN	348	550
DSP-2566-19-TT	348	676
DSP-2566-19-VV	348	676
DSP-2566-19-YY	348	550
DSP-2574-19-BB	349	699
DSP-2574-19-CC	349	466
DSP-2574-19-GG	349	1025
DSP-2574-19-KK	349	606
DSP-2574-19-LL	349	699
DSP-2574-19-NN	349	606
DSP-2574-19-TT	349	745
DSP-2574-19-VV	349	745
DSP-2574-19-YY	349	606
DSP-2584-19-BB	349	714
DSP-2584-19-CC	349	476
DSP-2584-19-GG	349	1047
DSP-2584-19-KK	349	619
DSP-2584-19-LL	349	714
DSP-2584-19-NN	349	619
DSP-2584-19-TT	349	761
DSP-2584-19-VV	349	761
DSP-2584-19-YY	349	619
DSP-2584-20-BB	349	786
DSP-2584-20-CC	349	524
DSP-2584-20-GG	349	1152
DSP-2584-20-KK	349	682
DSP-2584-20-LL	349	786
DSP-2584-20-NN	349	682
DSP-2584-20-TT	349	838
DSP-2584-20-VV	349	838
DSP-2584-20-YY	349	682
DSP-2604-19-BB	350	738
DSP-2604-19-CC	350	492
DSP-2604-19-GG	350	1083
DSP-2604-19-KK	350	639
DSP-2604-19-LL	350	738
DSP-2604-19-NN	350	639
DSP-2604-19-TT	350	787
DSP-2604-19-VV	350	787
DSP-2604-19-YY	350	639
DSP-2604-21-Bx	350	994
DSP-2604-21-Cx	350	641
DSP-2604-21-Gx	350	1443
DSP-2604-21-Kx	350	833
DSP-2604-21-Lx	350	994
DSP-2604-21-Nx	350	833
DSP-2604-21-Tx	350	1026
DSP-2604-21-Vx	350	1026
DSP-2604-21-Yx	350	833
DSP-2635-19-BB	350	801
DSP-2635-19-CC	350	534
DSP-2635-19-GG	350	1175
DSP-2635-19-KK	350	694
DSP-2635-19-LL	350	801
DSP-2635-19-NN	350	694
DSP-2635-19-TT	350	854

CODE	PAGE	PRICE
DSP-2635-19-VV	350	854
DSP-2635-19-YY	350	694
ELE-1001-01-BB	42	1350
ELE-1001-01-CC	42	1000
ELE-1001-01-GG	42	1500
ELE-1001-01-KK	42	1300
ELE-1001-01-KM	42	1450
ELE-1001-01-LL	42	1400
ELE-1001-01-SS	42	1300
ELE-1001-01-TT	42	1450
ELE-1001-01-VV	42	1450
ELE-1001-01-YY	42	1300
ELE-2001-01-BB	43	1485
ELE-2001-01-CC	43	1100
ELE-2001-01-EE	43	1540
ELE-2001-01-GG	43	1650
ELE-2001-01-HH	43	1540
ELE-2001-01-II	43	1540
ELE-2001-01-JJ	43	1540
ELE-2001-01-KK	43	1430
ELE-2001-01-KM	43	1595
ELE-2001-01-LL	43	1540
ELE-2001-01-NN	43	1430
ELE-2001-01-SS	43	1430
ELE-2001-01-TT	43	1595
ELE-2001-01-VV	43	1595
ELE-2001-01-YY	43	1430
EXC-6014-02-BB	308	255
EXC-6014-02-CC	308	170
EXC-6014-02-GG	308	374
EXC-6014-02-KK	308	221
EXC-6014-02-LL	308	255
EXC-6014-02-NN	308	221
EXC-6014-02-TT	308	272
EXC-6014-02-VV	308	272
EXC-6014-02-YY	308	221
EXT-2600-01	381	102
EXT-3404-00-BB	381	240
EXT-3404-00-CC	381	160
EXT-3404-00-GG	381	352
EXT-3404-00-KK	381	208
EXT-3404-00-LL	381	240
EXT-3404-00-NN	381	208
EXT-3404-00-TT	381	256
EXT-3404-00-VV	381	256
EXT-3404-00-YY	381	208
EXT-9520-30-BB	381	449
EXT-9520-30-CC	381	299
EXT-9520-30-GG	381	658
EXT-9520-30-KK	381	389
EXT-9520-30-LL	381	449
EXT-9520-30-NN	381	389
EXT-9520-30-TT	381	478
EXT-9520-30-VV	381	478
EXT-9520-30-YY	381	389
FIX-1100-00-B	72	135
INA-9030-02-BB	63	593
INA-9030-02-CC	63	395

Finishes:

CC = chrome, CD = chrome diamond, CF = smokey chrome, KK = matte black, LL = satin brass, BB = white, NN = brushed nickel, YY = polished nickel, TT = venetian bronze, VV = satin copper, GG = gold, KM = black titanium, CB = chrome white, KB = matte black white, LB = satin brass white, NB = brushed nickel white, YB = polished nickel white, TB = venetian bronze, VB = satin copper white, GB = gold white

PRICE INDEX

CODE	PAGE	PRICE
INA-9030-02-GG	63	869
INA-9030-02-KK	63	514
INA-9030-02-KM	63	632
INA-9030-02-LL	63	593
INA-9030-02-SS	63	514
INA-9030-02-TT	63	632
INA-9030-02-VV	63	632
INA-9030-02-YY	63	514
INA-9035-02-BB	63	593
INA-9035-02-CC	63	395
INA-9035-02-GG	63	869
INA-9035-02-KK	63	514
INA-9035-02-LL	63	593
INA-9035-02-SS	63	514
INA-9035-02-TT	63	632
INA-9035-02-VV	63	632
INA-9035-02-YY	63	514
KIT-9034-12-BB	381	252
KIT-9034-12-CC	381	168
KIT-9034-12-GG	381	370
KIT-9034-12-KK	381	218
KIT-9034-12-LL	381	252
KIT-9034-12-NN	381	218
KIT-9034-12-TT	381	269
KIT-9034-12-VV	381	269
KIT-9034-12-YY	381	218
M80-1030-10-Bx	233	188
M80-1030-10-Cx	233	125
M80-1030-10-Gx	233	275
M80-1030-10-Kx	233	163
M80-1030-10-Lx	233	188
M80-1030-10-Nx	233	163
M80-1030-10-Tx	233	200
M80-1030-10-Vx	233	200
M80-1030-10-Yx	233	163
M80-1030-20-Bx	233	188
M80-1030-20-Cx	233	125
M80-1030-20-Gx	233	275
M80-1030-20-Kx	233	163
M80-1030-20-Lx	233	188
M80-1030-20-Nx	233	163
M80-1030-20-Tx	233	200
M80-1030-20-Vx	233	200
M80-1030-20-Yx	233	163
M80-1030-30-Bx	233	188
M80-1030-30-Cx	233	125
M80-1030-30-Gx	233	275
M80-1030-30-Kx	233	163
M80-1030-30-Lx	233	188
M80-1030-30-Nx	233	163
M80-1030-30-Tx	233	200
M80-1030-30-Vx	233	200
M80-1030-30-Yx	233	163
M80-1030-40-Bx	233	188
M80-1030-40-Cx	233	125
M80-1030-40-Gx	233	275
M80-1030-40-Kx	233	163
M80-1030-40-Lx	233	188

CODE	PAGE	PRICE
M80-1030-40-Nx	233	163
M80-1030-40-Tx	233	200
M80-1030-40-Vx	233	200
M80-1030-40-Yx	233	163
M80-1100-10-Bx	240	188
M80-1100-10-Cx	240	125
M80-1100-10-Gx	240	275
M80-1100-10-Kx	240	163
M80-1100-10-Lx	240	188
M80-1100-10-Nx	240	163
M80-1100-10-Tx	240	200
M80-1100-10-Vx	240	200
M80-1100-10-Yx	240	163
M80-1100-20-Bx	240	188
M80-1100-20-Cx	240	125
M80-1100-20-Gx	240	275
M80-1100-20-Kx	240	163
M80-1100-20-Lx	240	188
M80-1100-20-Nx	240	163
M80-1100-20-Tx	240	200
M80-1100-20-Vx	240	200
M80-1100-20-Yx	240	163
M80-1100-30-Bx	240	188
M80-1100-30-Cx	240	125
M80-1100-30-Gx	240	275
M80-1100-30-Kx	240	163
M80-1100-30-Lx	240	188
M80-1100-30-Nx	240	163
M80-1100-30-Tx	240	200
M80-1100-30-Vx	240	200
M80-1100-30-Yx	240	163
M80-1100-40-Bx	240	188
M80-1100-40-Cx	240	125
M80-1100-40-Gx	240	275
M80-1100-40-Kx	240	163
M80-1100-40-Lx	240	188
M80-1100-40-Nx	240	163
M80-1100-40-Tx	240	200
M80-1100-40-Vx	240	200
M80-1100-40-Yx	240	163
M80-8000-110-Bx	235	375
M80-8000-110-Cx	235	250
M80-8000-110-Gx	235	550
M80-8000-110-Kx	235	325
M80-8000-110-Lx	235	375
M80-8000-110-Nx	235	325
M80-8000-110-Tx	235	400
M80-8000-110-Vx	235	400
M80-8000-110-Yx	235	325
M80-8000-220-Bx	235	375
M80-8000-220-Cx	235	250
M80-8000-220-Gx	235	550
M80-8000-220-Kx	235	325
M80-8000-220-Lx	235	375
M80-8000-220-Nx	235	325
M80-8000-220-Tx	235	400
M80-8000-220-Vx	235	400
M80-8000-220-Yx	235	325

CODE	PAGE	PRICE
M80-8000-330-Bx	235	375
M80-8000-330-Cx	235	250
M80-8000-330-Gx	235	550
M80-8000-330-Kx	235	325
M80-8000-330-Lx	235	375
M80-8000-330-Nx	235	325
M80-8000-330-Tx	235	400
M80-8000-330-Vx	235	400
M80-8000-330-Yx	235	325
M80-8000-330-YY	235	325
M80-8000-440-Bx	235	375
M80-8000-440-Cx	235	250
M80-8000-440-Gx	235	550
M80-8000-440-Kx	235	325
M80-8000-440-Lx	235	375
M80-8000-440-Nx	235	325
M80-8000-440-Tx	235	400
M80-8000-440-Vx	235	400
M80-8000-440-Yx	235	325
M80-8100-10-Bx	239	188
M80-8100-10-Cx	239	125
M80-8100-10-Gx	239	275
M80-8100-10-Kx	239	163
M80-8100-10-Lx	239	188
M80-8100-10-Nx	239	163
M80-8100-10-Tx	239	200
M80-8100-10-Vx	239	200
M80-8100-10-Yx	239	163
M80-8100-20-Bx	239	188
M80-8100-20-Cx	239	125
M80-8100-20-Gx	239	275
M80-8100-20-Kx	239	163
M80-8100-20-Lx	239	188
M80-8100-20-Nx	239	163
M80-8100-20-Tx	239	200
M80-8100-20-Vx	239	200
M80-8100-20-Yx	239	163
M80-8100-30-Bx	239	188
M80-8100-30-Cx	239	125
M80-8100-30-Gx	239	275
M80-8100-30-Kx	239	163
M80-8100-30-Lx	239	188
M80-8100-30-Nx	239	163
M80-8100-30-Tx	239	200
M80-8100-30-Vx	239	200
M80-8100-30-Yx	239	163
M80-8100-40-Bx	239	188
M80-8100-40-Cx	239	125
M80-8100-40-Gx	239	275
M80-8100-40-Kx	239	163
M80-8100-40-Lx	239	188
M80-8100-40-Nx	239	163
M80-8100-40-Tx	239	200
M80-8100-40-Vx	239	200
M80-8100-40-Yx	239	163
M80-9100-10-Bx	243	188
M80-9100-10-Cx	243	125
M80-9100-10-Gx	243	275

Actual products may differ from pictures. Actual products measures may differ from the measures shown. All USD prices are subject to change without notice. Effective as of August 2023.

PRICE INDEX

CODE	PAGE	PRICE
M80-9100-10-Kx	243	163
M80-9100-10-Lx	243	188
M80-9100-10-Nx	243	163
M80-9100-10-Tx	243	200
M80-9100-10-Vx	243	200
M80-9100-10-Yx	243	163
M80-9100-20-Bx	243	188
M80-9100-20-Cx	243	125
M80-9100-20-Gx	243	275
M80-9100-20-Kx	243	163
M80-9100-20-Lx	243	188
M80-9100-20-Nx	243	163
M80-9100-20-Tx	243	200
M80-9100-20-Vx	243	200
M80-9100-20-Yx	243	163
M80-9100-30-Bx	243	188
M80-9100-30-Cx	243	125
M80-9100-30-Gx	243	275
M80-9100-30-Kx	243	163
M80-9100-30-Lx	243	188
M80-9100-30-Nx	243	163
M80-9100-30-Tx	243	200
M80-9100-30-Vx	243	200
M80-9100-30-Yx	243	163
M80-9100-40-Bx	243	188
M80-9100-40-Cx	243	125
M80-9100-40-Gx	243	275
M80-9100-40-Kx	243	163
M80-9100-40-Lx	243	188
M80-9100-40-Nx	243	163
M80-9100-40-Tx	243	200
M80-9100-40-Vx	243	200
M80-9100-40-Yx	243	163
M80-9180-14-Bx	245	375
M80-9180-14-Cx	245	250
M80-9180-14-Gx	245	550
M80-9180-14-Kx	245	325
M80-9180-14-Lx	245	375
M80-9180-14-Nx	245	325
M80-9180-14-Tx	245	400
M80-9180-14-Vx	245	400
M80-9180-14-Yx	245	325
M80-9180-24-Bx	245	375
M80-9180-24-Cx	245	250
M80-9180-24-Gx	245	550
M80-9180-24-Kx	245	325
M80-9180-24-Lx	245	375
M80-9180-24-Nx	245	325
M80-9180-24-Tx	245	400
M80-9180-24-Vx	245	400
M80-9180-24-Yx	245	325
M80-9180-34-Bx	245	375
M80-9180-34-Cx	245	250
M80-9180-34-Gx	245	550
M80-9180-34-Kx	245	325
M80-9180-34-Lx	245	375
M80-9180-34-Nx	245	325
M80-9180-34-Tx	245	400

CODE	PAGE	PRICE
M80-9180-34-Vx	245	400
M80-9180-34-Yx	245	325
M80-9400-10-Bx	249	188
M80-9400-10-Cx	249	125
M80-9400-10-Gx	249	275
M80-9400-10-Kx	249	163
M80-9400-10-Lx	249	188
M80-9400-10-Nx	249	163
M80-9400-10-Tx	249	200
M80-9400-10-Vx	249	200
M80-9400-10-Yx	249	163
M80-9400-20-Bx	249	188
M80-9400-20-Cx	249	125
M80-9400-20-Gx	249	275
M80-9400-20-Kx	249	163
M80-9400-20-Lx	249	188
M80-9400-20-Nx	249	163
M80-9400-20-Tx	249	200
M80-9400-20-Vx	249	200
M80-9400-20-Yx	249	163
M80-9400-30-Bx	249	188
M80-9400-30-Cx	249	125
M80-9400-30-Gx	249	275
M80-9400-30-Kx	249	163
M80-9400-30-Lx	249	188
M80-9400-30-Nx	249	163
M80-9400-30-Tx	249	200
M80-9400-30-Vx	249	200
M80-9400-30-Yx	249	163
M80-9400-40-Bx	249	188
M80-9400-40-Cx	249	125
M80-9400-40-Gx	249	275
M80-9400-40-Kx	249	163
M80-9400-40-Lx	249	188
M80-9400-40-Nx	249	163
M80-9400-40-Tx	249	200
M80-9400-40-Vx	249	200
M80-9400-40-Yx	249	163
M80-9453-10-Bx	251	526
M80-9453-10-Cx	251	350
M80-9453-10-Gx	251	770
M80-9453-10-Kx	251	456
M80-9453-10-Lx	251	526
M80-9453-10-Nx	251	456
M80-9453-10-Tx	251	560
M80-9453-10-Vx	251	560
M80-9453-10-Yx	251	456
M80-9453-20-Bx	251	526
M80-9453-20-Cx	251	350
M80-9453-20-Gx	251	770
M80-9453-20-Kx	251	456
M80-9453-20-Lx	251	526
M80-9453-20-Nx	251	456
M80-9453-20-Tx	251	560
M80-9453-20-Vx	251	560
M80-9453-20-Yx	251	456
M80-9453-30-Bx	251	526
M80-9453-30-Cx	251	350

CODE	PAGE	PRICE
M80-9453-30-Gx	251	770
M80-9453-30-Kx	251	456
M80-9453-30-Lx	251	526
M80-9453-30-Nx	251	456
M80-9453-30-Tx	251	560
M80-9453-30-Vx	251	560
M80-9453-30-Yx	251	456
M80-9453-40-Bx	251	526
M80-9453-40-Cx	251	350
M80-9453-40-Gx	251	770
M80-9453-40-Kx	251	456
M80-9453-40-Lx	251	526
M80-9453-40-Nx	251	456
M80-9453-40-Tx	251	560
M80-9453-40-Vx	251	560
M80-9453-40-Yx	251	456
M80-9500-10-Bx	260	188
M80-9500-10-Cx	260	125
M80-9500-10-Gx	260	275
M80-9500-10-Kx	260	163
M80-9500-10-Lx	260	188
M80-9500-10-Nx	260	163
M80-9500-10-Tx	260	200
M80-9500-10-Vx	260	200
M80-9500-10-Yx	260	163
M80-9500-20-Bx	260	188
M80-9500-20-Cx	260	125
M80-9500-20-Gx	260	275
M80-9500-20-Kx	260	163
M80-9500-20-Lx	260	188
M80-9500-20-Nx	260	163
M80-9500-20-Tx	260	200
M80-9500-20-Vx	260	200
M80-9500-20-Yx	260	163
M80-9500-30-Bx	260	188
M80-9500-30-Cx	260	125
M80-9500-30-Gx	260	275
M80-9500-30-Kx	260	163
M80-9500-30-Lx	260	188
M80-9500-30-Nx	260	163
M80-9500-30-Tx	260	200
M80-9500-30-Vx	260	200
M80-9500-30-Yx	260	163
M80-9500-40-Bx	260	188
M80-9500-40-Cx	260	125
M80-9500-40-Gx	260	275
M80-9500-40-Kx	260	163
M80-9500-40-Lx	260	188
M80-9500-40-Nx	260	163
M80-9500-40-Tx	260	200
M80-9500-40-Vx	260	200
M80-9500-40-Yx	260	163
M80-9520-110-Bx	252	375
M80-9520-110-Cx	252	250
M80-9520-110-Gx	252	550
M80-9520-110-Kx	252	325
M80-9520-110-Lx	252	375
M80-9520-110-Nx	252	325

Finishes:

CC = chrome, CD = chrome diamond, CF = smokey chrome, KK = matte black, LL = satin brass, BB = white, NN = brushed nickel, YY = polished nickel, TT = venetian bronze, VV = satin copper, GG = gold, KM = black titanium, CB = chrome white, KB = matte black white, LB = satin brass white, NB = brushed nickel white, YB = polished nickel white, TB = venetian bronze, VB = satin copper white, GB = gold white

PRICE INDEX

CODE	PAGE	PRICE
M80-9520-110-Tx	252	400
M80-9520-110-Vx	252	400
M80-9520-110-Yx	252	325
M80-9520-120-Bx	252	375
M80-9520-120-Cx	252	250
M80-9520-120-Gx	252	550
M80-9520-120-Kx	252	325
M80-9520-120-Lx	252	375
M80-9520-120-Nx	252	325
M80-9520-120-Tx	252	400
M80-9520-120-Vx	252	400
M80-9520-120-Yx	252	325
M80-9520-130-Bx	252	375
M80-9520-130-Cx	252	250
M80-9520-130-Gx	252	550
M80-9520-130-Kx	252	325
M80-9520-130-Lx	252	375
M80-9520-130-Nx	252	325
M80-9520-130-Tx	252	400
M80-9520-130-Vx	252	400
M80-9520-130-Yx	252	325
M80-9520-220-Bx	252	375
M80-9520-220-Cx	252	250
M80-9520-220-Gx	252	550
M80-9520-220-Kx	252	325
M80-9520-220-Lx	252	375
M80-9520-220-Nx	252	325
M80-9520-220-Tx	252	400
M80-9520-220-Vx	252	400
M80-9520-220-Yx	252	325
M80-9520-230-Bx	252	375
M80-9520-230-Cx	252	250
M80-9520-230-Gx	252	550
M80-9520-230-Kx	252	325
M80-9520-230-Lx	252	375
M80-9520-230-Nx	252	325
M80-9520-230-Tx	252	400
M80-9520-230-Vx	252	400
M80-9520-230-Yx	252	325
M80-9520-330-Bx	252	375
M80-9520-330-Cx	252	250
M80-9520-330-Gx	252	550
M80-9520-330-Kx	252	325
M80-9520-330-Lx	252	375
M80-9520-330-Nx	252	325
M80-9520-330-Tx	252	400
M80-9520-330-Vx	252	400
M80-9520-330-Yx	252	325
MON-2600-00L-BB	224	1527
MON-2600-00L-CB	224	1018
MON-2600-00L-GB	224	2240
MON-2600-00L-KB	224	1323
MON-2600-00L-LB	224	1527
MON-2600-00L-NB	224	1323
MON-2600-00L-TB	224	1629
MON-2600-00L-VB	224	1629
MON-2600-00L-YB	224	1323
PLA-0423-01-BB	308	98

CODE	PAGE	PRICE
PLA-0423-01-CC	308	65
PLA-0423-01-GG	308	143
PLA-0423-01-KK	308	85
PLA-0423-01-LL	308	98
PLA-0423-01-NN	308	85
PLA-0423-01-TT	308	104
PLA-0423-01-VV	308	104
PLA-0423-01-YY	308	85
PLA-0430-00-BB	308	98
PLA-0430-00-CC	308	65
PLA-0430-00-GG	308	143
PLA-0430-00-KK	308	85
PLA-0430-00-KM	308	104
PLA-0430-00-LL	308	98
PLA-0430-00-NN	308	85
PLA-0430-00-TT	308	104
PLA-0430-00-VV	308	104
PLA-0430-00-YY	308	85
PLA-0440-00-BB	308	98
PLA-0440-00-CC	308	65
PLA-0440-00-GG	308	143
PLA-0440-00-KK	308	85
PLA-0440-00-LL	308	98
PLA-0440-00-NN	308	85
PLA-0440-00-TT	308	104
PLA-0440-00-VV	308	104
PLA-0440-00-YY	308	85
PLA-0813-01-BB	60	119
PLA-0813-01-CC	60	79
PLA-0813-01-GG	60	174
PLA-0813-01-KK	60	103
PLA-0813-01-KM	60	126
PLA-0813-01-LL	60	119
PLA-0813-01-SS	60	103
PLA-0813-01-TT	60	126
PLA-0813-01-VV	60	126
PLA-0813-01-YY	60	103
PLA-0813-02-BB	61	119
PLA-0813-02-CC	61	79
PLA-0813-02-GG	61	174
PLA-0813-02-KK	61	103
PLA-0813-02-LL	61	119
PLA-0813-02-TT	61	126
PLA-0813-02-VV	61	126
PLA-0813-02-YY	61	103
PRO-1100-16-BB	115	3743
PRO-1100-16-CC	115	2495
PRO-1100-16-GG	115	5489
PRO-1100-16-KK	115	3244
PRO-1100-16-LL	115	3743
PRO-1100-16-NN	115	3244
PRO-1100-16-TT	115	3992
PRO-1100-16-VV	115	3992
PRO-1100-16-YY	115	3244
PRO-1100-53-BB	107	2663
PRO-1100-53-CC	107	1775
PRO-1100-53-GG	107	3905
PRO-1100-53-KK	107	2308

CODE	PAGE	PRICE
PRO-1100-53-LL	107	2663
PRO-1100-53-NN	107	2308
PRO-1100-53-TT	107	2840
PRO-1100-53-VV	107	2840
PRO-1100-53-YY	107	2308
PRO-1100-71-BB	221	3743
PRO-1100-71-CC	221	2495
PRO-1100-71-GG	221	5489
PRO-1100-71-KK	221	3244
PRO-1100-71-LL	221	3743
PRO-1100-71-NN	221	3244
PRO-1100-71-TT	221	3992
PRO-1100-71-VV	221	3992
PRO-1100-71-YY	221	3244
PRO-1100-74-BB	229	3743
PRO-1100-74-CC	229	2495
PRO-1100-74-GG	229	5489
PRO-1100-74-KK	229	3244
PRO-1100-74-LL	229	3743
PRO-1100-74-NN	229	3244
PRO-1100-74-TT	229	3992
PRO-1100-74-VV	229	3992
PRO-1100-74-YY	229	3244
PRO-1101-53-BB	265	2843
PRO-1101-53-CC	265	1895
PRO-1101-53-GG	265	4169
PRO-1101-53-KK	265	2464
PRO-1101-53-LL	265	2843
PRO-1101-53-NN	265	2464
PRO-1101-53-TT	265	3032
PRO-1101-53-VV	265	3032
PRO-1101-53-YY	265	2464
PRO-1102-53-BB	265	2993
PRO-1102-53-CC	265	1995
PRO-1102-53-GG	265	4389
PRO-1102-53-KK	265	2594
PRO-1102-53-LL	265	2993
PRO-1102-53-NN	265	2594
PRO-1102-53-TT	265	3192
PRO-1102-53-VV	265	3192
PRO-1102-53-YY	265	2594
PRO-1104-53-BB	79	2693
PRO-1104-53-CC	79	1795
PRO-1104-53-GG	79	3949
PRO-1104-53-KK	79	2334
PRO-1104-53-LL	79	2693
PRO-1104-53-NN	79	2334
PRO-1104-53-TT	79	2872
PRO-1104-53-VV	79	2872
PRO-1104-53-YY	79	2334
PRO-1401-03-BB	97	3368
PRO-1401-03-CC	97	2245
PRO-1401-03-GG	97	4939
PRO-1401-03-KK	97	2919
PRO-1401-03-LL	97	3368
PRO-1401-03-NN	97	2919
PRO-1401-03-TT	97	3592
PRO-1401-03-VV	97	3592

Actual products may differ from pictures. Actual products measures may differ from the measures shown. All USD prices are subject to change without notice. Effective as of August 2023.

PRICE INDEX

CODE	PAGE	PRICE
PRO-1401-03-YY	97	2919
PRO-2100-04-BB	79	1797
PRO-2100-04-CC	79	1198
PRO-2100-04-GG	79	2636
PRO-2100-04-KK	79	1557
PRO-2100-04-LL	79	1797
PRO-2100-04-NN	79	1557
PRO-2100-04-TT	79	1917
PRO-2100-04-VV	79	1917
PRO-2100-04-YY	79	1557
PRO-2101-80-BB	266	1605
PRO-2101-80-CC	266	1070
PRO-2101-80-GG	266	2354
PRO-2101-80-KK	266	1391
PRO-2101-80-LL	266	1605
PRO-2101-80-NN	266	1391
PRO-2101-80-TT	266	1712
PRO-2101-80-VV	266	1712
PRO-2101-80-YY	266	1391
PRO-2102-80-BB	267	1605
PRO-2102-80-CC	267	1070
PRO-2102-80-GG	267	2354
PRO-2102-80-KK	267	1391
PRO-2102-80-LL	267	1605
PRO-2102-80-NN	267	1391
PRO-2102-80-TT	267	1712
PRO-2102-80-VV	267	1712
PRO-2102-80-YY	267	1391
PRO-2105-45-BB	145	1763
PRO-2105-45-CC	145	1175
PRO-2105-45-GG	145	2585
PRO-2105-45-KK	145	1528
PRO-2105-45-LL	145	1763
PRO-2105-45-NN	145	1528
PRO-2105-45-TT	145	1880
PRO-2105-45-VV	145	1880
PRO-2105-45-YY	145	1528
PRO-2115-66-BB	207	1410
PRO-2115-66-CC	207	940
PRO-2115-66-GG	207	2068
PRO-2115-66-KK	207	1222
PRO-2115-66-LL	207	1410
PRO-2115-66-NN	207	1222
PRO-2115-66-TT	207	1504
PRO-2115-66-VV	207	1504
PRO-2115-66-YY	207	1222
PRO-2175-95-BB	97	1874
PRO-2175-95-CC	97	1249
PRO-2175-95-GG	97	2748
PRO-2175-95-KK	97	1624
PRO-2175-95-LL	97	1874
PRO-2175-95-NN	97	1624
PRO-2175-95-TT	97	1998
PRO-2175-95-VV	97	1998
PRO-2175-95-YY	97	1624
PRO-2200-04-BB	79	2063
PRO-2200-04-CC	79	1375
PRO-2200-04-GG	79	3025

CODE	PAGE	PRICE
PRO-2200-04-KK	79	1788
PRO-2200-04-LL	79	2063
PRO-2200-04-NN	79	1788
PRO-2200-04-TT	79	2200
PRO-2200-04-VV	79	2200
PRO-2200-04-YY	79	1788
PRO-2201-80-BB	268	1911
PRO-2201-80-CC	268	1264
PRO-2201-80-GG	268	2781
PRO-2201-80-KK	268	1643
PRO-2201-80-LL	268	1896
PRO-2201-80-NN	268	1643
PRO-2201-80-TT	268	2022
PRO-2201-80-VV	268	2022
PRO-2201-80-YY	268	1643
PRO-2202-80-BB	269	1896
PRO-2202-80-CC	269	1264
PRO-2202-80-GG	269	2781
PRO-2202-80-KK	269	1643
PRO-2202-80-LL	269	1896
PRO-2202-80-NN	269	1643
PRO-2202-80-TT	269	2022
PRO-2202-80-VV	269	2022
PRO-2202-80-YY	269	1643
PRO-2210-66-BB	207	1124
PRO-2210-66-CC	207	749
PRO-2210-66-GG	207	1648
PRO-2210-66-KK	207	974
PRO-2210-66-LL	207	1124
PRO-2210-66-NN	207	974
PRO-2210-66-TT	207	1198
PRO-2210-66-VV	207	1198
PRO-2210-66-YY	207	974
PRO-2220-66-BB	208	1632
PRO-2220-66-CC	208	1088
PRO-2220-66-GG	208	2394
PRO-2220-66-KK	208	1414
PRO-2220-66-LL	208	1632
PRO-2220-66-NN	208	1414
PRO-2220-66-TT	208	1741
PRO-2220-66-VV	208	1741
PRO-2220-66-YY	208	1414
PRO-2800-14-BB	107	2738
PRO-2800-14-CC	107	1825
PRO-2800-14-GG	107	4015
PRO-2800-14-KK	107	2373
PRO-2800-14-LL	107	2738
PRO-2800-14-NN	107	2373
PRO-2800-14-TT	107	2920
PRO-2800-14-VV	107	2920
PRO-2800-14-YY	107	2373
PRO-2801-80-BB	270	2588
PRO-2801-80-CC	270	1725
PRO-2801-80-GG	270	3795
PRO-2801-80-KK	270	2243
PRO-2801-80-LL	270	2588
PRO-2801-80-NN	270	2243
PRO-2801-80-TT	270	2760

CODE	PAGE	PRICE
PRO-2801-80-VV	270	2760
PRO-2801-80-YY	270	2243
PRO-2802-80-BB	271	2603
PRO-2802-80-CC	271	1735
PRO-2802-80-GG	271	3817
PRO-2802-80-KK	271	2256
PRO-2802-80-LL	271	2603
PRO-2802-80-NN	271	2256
PRO-2802-80-TT	271	2776
PRO-2802-80-VV	271	2776
PRO-2802-80-YY	271	2256
PRO-2805-04-BB	80	2697
PRO-2805-04-CC	80	1798
PRO-2805-04-GG	80	3956
PRO-2805-04-KK	80	2337
PRO-2805-04-LL	80	2697
PRO-2805-04-NN	80	2337
PRO-2805-04-TT	80	2877
PRO-2805-04-VV	80	2877
PRO-2805-04-YY	80	2337
PRO-2805-45-BB	145	2697
PRO-2805-45-CC	145	1798
PRO-2805-45-GG	145	3956
PRO-2805-45-KK	145	2337
PRO-2805-45-LL	145	2697
PRO-2805-45-NN	145	2337
PRO-2805-45-TT	145	2877
PRO-2805-45-VV	145	2877
PRO-2805-45-YY	145	2337
PRO-2805-66-BB	208	2397
PRO-2805-66-CC	208	1598
PRO-2805-66-GG	208	3516
PRO-2805-66-KK	208	2077
PRO-2805-66-LL	208	2397
PRO-2805-66-NN	208	2077
PRO-2805-66-TT	208	2557
PRO-2805-66-VV	208	2557
PRO-2805-66-YY	208	2077
PRO-2805-95-BB	97	2984
PRO-2805-95-CC	97	1989
PRO-2805-95-GG	97	4376
PRO-2805-95-KK	97	2586
PRO-2805-95-LL	97	2984
PRO-2805-95-NN	97	2586
PRO-2805-95-TT	97	3182
PRO-2805-95-VV	97	3182
PRO-2805-95-YY	97	2586
PRO-2811-80-CC	272	1795
PRO-2811-80-KK	272	2334
PRO-2812-80-CC	273	1825
PRO-2812-80-KK	273	2373
PRO-2815-04-CC	80	1883
PRO-2815-04-KK	80	2448
PRO-2815-45-CC	146	1545
PRO-2815-45-KK	146	2009
PRO-2815-46-CC	161	1595
PRO-2815-46-KK	161	2074
PRO-2815-66-CC	208	1495

Finishes:

CC = chrome, CD = chrome diamond, CF = smokey chrome, KK = matte black, LL = satin brass, BB = white, NN = brushed nickel, YY = polished nickel, TT = venetian bronze, VV = satin copper, GG = gold, KM = black titanium, CB = chrome white, KB = matte black white, LB = satin brass white, NB = brushed nickel white, YB = polished nickel white, TB = venetian bronze, VB = satin copper white, GB = gold white

PRICE INDEX

CODE	PAGE	PRICE
PRO-2815-95-CC	98	1695
PRO-2816-66-CC	209	1345
PRO-2816-66-KK	209	1749
PRO-2826-66-CC	209	1495
PRO-2826-66-KK	209	1944
PRO-2891-80-BB	274	2243
PRO-2891-80-CC	274	1495
PRO-2891-80-GG	274	3289
PRO-2891-80-KK	274	1944
PRO-2891-80-LL	274	2243
PRO-2891-80-NN	274	1944
PRO-2891-80-TT	274	2392
PRO-2891-80-VV	274	2392
PRO-2891-80-YY	274	1944
PRO-2892-80-BB	275	2280
PRO-2892-80-CC	275	1520
PRO-2892-80-GG	275	3344
PRO-2892-80-KK	275	1976
PRO-2892-80-LL	275	2280
PRO-2892-80-NN	275	1976
PRO-2892-80-TT	275	2432
PRO-2892-80-VV	275	2432
PRO-2892-80-YY	275	1976
PRO-2896-04-BB	80	2393
PRO-2896-04-CC	80	1595
PRO-2896-04-GG	80	3509
PRO-2896-04-KK	80	2074
PRO-2896-04-LL	80	2393
PRO-2896-04-NN	80	2074
PRO-2896-04-TT	80	2552
PRO-2896-04-VV	80	2552
PRO-2896-04-YY	80	2074
PRO-2896-05-BB	98	2489
PRO-2896-05-CC	98	1659
PRO-2896-05-GG	98	3650
PRO-2896-05-KK	98	2157
PRO-2896-05-LL	98	2489
PRO-2896-05-NN	98	2157
PRO-2896-05-TT	98	2654
PRO-2896-05-VV	98	2654
PRO-2896-05-YY	98	2157
PRO-2896-45-BB	146	2363
PRO-2896-45-CC	146	1575
PRO-2896-45-GG	146	3465
PRO-2896-45-KK	146	2048
PRO-2896-45-LL	146	2363
PRO-2896-45-NN	146	2048
PRO-2896-45-TT	146	2520
PRO-2896-45-VV	146	2520
PRO-2896-45-YY	146	2048
PRO-2896-46-BB	161	2393
PRO-2896-46-CC	161	1595
PRO-2896-46-GG	161	3509
PRO-2896-46-KK	161	2074
PRO-2896-46-LL	161	2393
PRO-2896-46-NN	161	2074
PRO-2896-46-TT	161	2552
PRO-2896-46-VV	161	2552

CODE	PAGE	PRICE
PRO-2896-46-YY	161	2074
PRO-2896-66-BB	209	2288
PRO-2896-66-CC	209	1525
PRO-2896-66-GG	209	3355
PRO-2896-66-KK	209	1983
PRO-2896-66-LL	209	2288
PRO-2896-66-NN	209	1983
PRO-2896-66-TT	209	2440
PRO-2896-66-VV	209	2440
PRO-2896-66-YY	209	1983
PRO-2901-80-CC	276	1975
PRO-2902-80-CC	277	1995
PRO-2915-04-CC	81	2057
PRO-2915-04-KK	81	2674
PRO-2915-45-CC	146	1719
PRO-2915-45-KK	146	2235
PRO-2915-66-CC	210	1675
PRO-3301-80-BB	278	3396
PRO-3301-80-CC	278	2264
PRO-3301-80-GG	278	4981
PRO-3301-80-KK	278	2943
PRO-3301-80-LL	278	3396
PRO-3301-80-NN	278	2943
PRO-3301-80-TT	278	3622
PRO-3301-80-VV	278	3622
PRO-3301-80-YY	278	2943
PRO-3302-04-BB	81	3525
PRO-3302-04-CC	81	2350
PRO-3302-04-GG	81	5170
PRO-3302-04-KK	81	3055
PRO-3302-04-LL	81	3525
PRO-3302-04-NN	81	3055
PRO-3302-04-TT	81	3760
PRO-3302-04-VV	81	3760
PRO-3302-04-YY	81	3055
PRO-3302-45-BB	147	3653
PRO-3302-45-CC	147	2435
PRO-3302-45-GG	147	5357
PRO-3302-45-KK	147	3166
PRO-3302-45-LL	147	3653
PRO-3302-45-LL	147	3653
PRO-3302-45-NN	147	3166
PRO-3302-45-TT	147	3896
PRO-3302-45-VV	147	3896
PRO-3302-45-YY	147	3166
PRO-3302-46-BB	162	3443
PRO-3302-46-CC	162	2295
PRO-3302-46-GG	162	5049
PRO-3302-46-KK	162	2984
PRO-3302-46-LL	162	3443
PRO-3302-46-NN	162	2984
PRO-3302-46-TT	162	3672
PRO-3302-46-VV	162	3672
PRO-3302-46-YY	162	2984
PRO-3302-47-Bx	175	4793
PRO-3302-47-Cx	175	3195
PRO-3302-47-Gx	175	7029
PRO-3302-47-Kx	175	4154
PRO-3302-47-Lx	175	4793

CODE	PAGE	PRICE
PRO-3302-47-Nx	175	4154
PRO-3302-47-Tx	175	5112
PRO-3302-47-Vx	175	5112
PRO-3302-47-Yx	175	4154
PRO-3302-66-BB	210	3552
PRO-3302-66-CC	210	2368
PRO-3302-66-GG	210	5210
PRO-3302-66-KK	210	3078
PRO-3302-66-LL	210	3552
PRO-3302-66-NN	210	3078
PRO-3302-66-TT	210	3789
PRO-3302-66-VV	210	3789
PRO-3302-66-YY	210	3078
PRO-3302-80-BB	280	3443
PRO-3302-80-CC	280	2295
PRO-3302-80-GG	280	5049
PRO-3302-80-KK	280	2984
PRO-3302-80-LL	280	3443
PRO-3302-80-NN	280	2984
PRO-3302-80-TT	280	3672
PRO-3302-80-VV	280	3672
PRO-3302-80-YY	280	2984
PRO-3303-47-Bx	175	5175
PRO-3303-47-Cx	175	3450
PRO-3303-47-Gx	175	7590
PRO-3303-47-Kx	175	4485
PRO-3303-47-Lx	175	5175
PRO-3303-47-Nx	175	4485
PRO-3303-47-Tx	175	5520
PRO-3303-47-Vx	175	5520
PRO-3303-47-Yx	175	4485
PRO-3304-47-Bx	176	3443
PRO-3304-47-Cx	176	2295
PRO-3304-47-Gx	176	5049
PRO-3304-47-Kx	176	2984
PRO-3304-47-Lx	176	3443
PRO-3304-47-Nx	176	2984
PRO-3304-47-Tx	176	3672
PRO-3304-47-Vx	176	3672
PRO-3304-47-Yx	176	2984
PRO-3311-80-BB	282	2745
PRO-3311-80-CC	282	1830
PRO-3311-80-GG	282	4026
PRO-3311-80-KK	282	2379
PRO-3311-80-LL	282	2745
PRO-3311-80-NN	282	2379
PRO-3311-80-TT	282	2928
PRO-3311-80-VV	282	2928
PRO-3311-80-YY	282	2379
PRO-3352-47-Bx	176	4778
PRO-3352-47-Cx	176	3185
PRO-3352-47-Gx	176	7007
PRO-3352-47-Kx	176	4141
PRO-3352-47-Lx	176	4778
PRO-3352-47-Nx	176	4141
PRO-3352-47-Tx	176	5096
PRO-3352-47-Vx	176	5096
PRO-3352-47-Yx	176	4141

Actual products may differ from pictures. Actual products measures may differ from the measures shown. All USD prices are subject to change without notice. Effective as of August 2023.

PRICE INDEX

CODE	PAGE	PRICE
PRO-3405-04-BB	81	3659
PRO-3405-04-CC	81	2439
PRO-3405-04-GG	81	5366
PRO-3405-04-KK	81	3171
PRO-3405-04-LL	81	3659
PRO-3405-04-NN	81	3171
PRO-3405-04-TT	81	3902
PRO-3405-04-VV	81	3902
PRO-3405-04-YY	81	3171
PRO-3405-05-BB	98	4118
PRO-3405-05-CC	98	2745
PRO-3405-05-GG	98	6039
PRO-3405-05-KK	98	3569
PRO-3405-05-LL	98	4118
PRO-3405-05-NN	98	3569
PRO-3405-05-TT	98	4392
PRO-3405-05-VV	98	4392
PRO-3405-05-YY	98	3569
PRO-3405-45-BB	147	3743
PRO-3405-45-CC	147	2495
PRO-3405-45-GG	147	5489
PRO-3405-45-KK	147	3244
PRO-3405-45-LL	147	3743
PRO-3405-45-NN	147	3244
PRO-3405-45-TT	147	3992
PRO-3405-45-VV	147	3992
PRO-3405-45-YY	147	3244
PRO-3405-66-BB	210	3443
PRO-3405-66-CC	210	2295
PRO-3405-66-GG	210	5049
PRO-3405-66-KK	210	2984
PRO-3405-66-LL	210	3443
PRO-3405-66-NN	210	2984
PRO-3405-66-TT	210	3672
PRO-3405-66-VV	210	3672
PRO-3405-66-YY	210	2984
PRO-3420-16-BB	115	3518
PRO-3420-16-CC	115	2345
PRO-3420-16-GG	115	5159
PRO-3420-16-KK	115	3049
PRO-3420-16-LL	115	3518
PRO-3420-16-NN	115	3049
PRO-3420-16-TT	115	3752
PRO-3420-16-VV	115	3752
PRO-3420-16-YY	115	3049
PRO-3420-18-BB	116	3518
PRO-3420-18-CB	116	2345
PRO-3420-18-CC	116	2345
PRO-3420-18-GB	116	5159
PRO-3420-18-GG	116	5159
PRO-3420-18-KB	116	3049
PRO-3420-18-KK	116	3049
PRO-3420-18-LB	116	3518
PRO-3420-18-LL	116	3518
PRO-3420-18-NB	116	3049
PRO-3420-18-NN	116	3049
PRO-3420-18-TB	116	3752
PRO-3420-18-TT	116	3752

CODE	PAGE	PRICE
PRO-3420-18-VB	116	3752
PRO-3420-18-VV	116	3752
PRO-3420-18-YB	116	3049
PRO-3420-18-YY	116	3049
PRO-3420-26-CD	123	3795
PRO-3420-27-BB	124	4380
PRO-3420-27-CC	124	2920
PRO-3420-27-GG	124	6424
PRO-3420-27-KK	124	3796
PRO-3420-27-LL	124	4380
PRO-3420-27-NN	124	3796
PRO-3420-27-TT	124	4672
PRO-3420-27-VV	124	4672
PRO-3420-27-YY	124	3796
PRO-3420-28-BB	124	4380
PRO-3420-28-CC	124	2920
PRO-3420-28-GG	124	6424
PRO-3420-28-KK	124	3796
PRO-3420-28-LL	124	4380
PRO-3420-28-NN	124	3796
PRO-3420-28-TT	124	4672
PRO-3420-28-VV	124	4672
PRO-3420-28-YY	124	3796
PRO-3420-71-BB	221	4125
PRO-3420-71-CC	221	2750
PRO-3420-71-GG	221	6050
PRO-3420-71-KK	221	3575
PRO-3420-71-LL	221	4125
PRO-3420-71-NN	221	3575
PRO-3420-71-TT	221	4400
PRO-3420-71-VV	221	4400
PRO-3420-71-YY	221	3575
PRO-3420-72-BB	221	4125
PRO-3420-72-CC	221	2750
PRO-3420-72-GG	221	6050
PRO-3420-72-KK	221	3575
PRO-3420-72-LL	221	4125
PRO-3420-72-NN	221	3575
PRO-3420-72-TT	221	4400
PRO-3420-72-VV	221	4400
PRO-3420-72-YY	221	3575
PRO-3420-74-BB	229	4125
PRO-3420-74-CB	229	2750
PRO-3420-74-GB	229	6050
PRO-3420-74-KB	229	3575
PRO-3420-74-LB	229	4125
PRO-3420-74-NB	229	3575
PRO-3420-74-TB	229	4400
PRO-3420-74-VB	229	4400
PRO-3420-74-YB	229	3575
PRO-3950-04-BB	81	5693
PRO-3950-04-CC	81	3795
PRO-3950-04-GG	81	8349
PRO-3950-04-KK	81	4934
PRO-3950-04-LL	81	5693
PRO-3950-04-NN	81	4934
PRO-3950-04-TT	81	6072
PRO-3950-04-VV	81	6072

CODE	PAGE	PRICE
PRO-3950-04-YY	81	4934
PRO-3950-46-BB	162	6428
PRO-3950-46-CC	162	4285
PRO-3950-46-GG	162	9427
PRO-3950-46-KK	162	5571
PRO-3950-46-LL	162	6428
PRO-3950-46-NN	162	5571
PRO-3950-46-TT	162	6856
PRO-3950-46-VV	162	6856
PRO-3950-46-YY	162	5571
PRO-3950-56-CB	191	5075
PRO-3950-56-CC	191	5075
PRO-3950-56-CF	191	5075
PRO-4201-66-BB	211	2835
PRO-4201-66-CC	211	1890
PRO-4201-66-GG	211	4158
PRO-4201-66-KK	211	2457
PRO-4201-66-LL	211	2835
PRO-4201-66-NN	211	2457
PRO-4201-66-TT	211	3024
PRO-4201-66-VV	211	3024
PRO-4201-66-YY	211	2457
PRO-4201-80-BB	284	3068
PRO-4201-80-CC	284	2045
PRO-4201-80-GG	284	4499
PRO-4201-80-KK	284	2659
PRO-4201-80-LL	284	3068
PRO-4201-80-NN	284	2659
PRO-4201-80-TT	284	3272
PRO-4201-80-VV	284	3272
PRO-4201-80-YY	284	2659
PRO-4202-80-BB	285	3165
PRO-4202-80-CC	285	2110
PRO-4202-80-GG	285	4642
PRO-4202-80-KK	285	2743
PRO-4202-80-LL	285	3165
PRO-4202-80-NN	285	2743
PRO-4202-80-TT	285	3376
PRO-4202-80-VV	285	3376
PRO-4202-80-YY	285	2743
PRO-4205-04-BB	82	3015
PRO-4205-04-CC	82	2010
PRO-4205-04-GG	82	4422
PRO-4205-04-KK	82	2613
PRO-4205-04-KM	82	3216
PRO-4205-04-LL	82	3015
PRO-4205-04-NN	82	2613
PRO-4205-04-TT	82	3216
PRO-4205-04-VV	82	3216
PRO-4205-04-YY	82	2613
PRO-4206-05-BB	99	3165
PRO-4206-05-CC	99	2110
PRO-4206-05-GG	99	4642
PRO-4206-05-KK	99	2743
PRO-4206-05-LL	99	3165
PRO-4206-05-NN	99	2743
PRO-4206-05-TT	99	3376
PRO-4206-05-VV	99	3376

Finishes:

CC = chrome, CD = chrome diamond, CF = smokey chrome, KK = matte black, LL = satin brass, BB = white, NN = brushed nickel, YY = polished nickel, TT = venetian bronze, VV = satin copper, GG = gold, KM = black titanium, CB = chrome white, KB = matte black white, LB = satin brass white, NB = brushed nickel white, YB = polished nickel white, TB = venetian bronze, VB = satin copper white, GB = gold white

PRICE INDEX

CODE	PAGE	PRICE
PRO-4206-05-YY	99	2743
PRO-4206-45-BB	147	2918
PRO-4206-45-CC	147	1945
PRO-4206-45-GG	147	4279
PRO-4206-45-KK	147	2529
PRO-4206-45-LL	147	2918
PRO-4206-45-NN	147	2529
PRO-4206-45-TT	147	3112
PRO-4206-45-VV	147	3112
PRO-4206-45-YY	147	2529
PRO-4206-46-BB	162	3203
PRO-4206-46-CC	162	2135
PRO-4206-46-GG	162	4697
PRO-4206-46-KK	162	2776
PRO-4206-46-LL	162	3203
PRO-4206-46-NN	162	2776
PRO-4206-46-TT	162	3416
PRO-4206-46-VV	162	3416
PRO-4206-46-YY	162	2776
PRO-4206-66-BB	211	2685
PRO-4206-66-CC	211	1790
PRO-4206-66-GG	211	3938
PRO-4206-66-KK	211	2327
PRO-4206-66-LL	211	2685
PRO-4206-66-NN	211	2327
PRO-4206-66-TT	211	2864
PRO-4206-66-VV	211	2864
PRO-4206-66-YY	211	2327
PRO-4211-80-CC	286	2075
PRO-4211-80-KK	286	2698
PRO-4212-80-CC	287	2125
PRO-4212-80-KK	287	2763
PRO-4215-04-CC	82	2125
PRO-4215-04-KK	82	2763
PRO-4216-05-CC	99	2225
PRO-4216-05-KK	99	2893
PRO-4216-45-CC	148	1795
PRO-4216-45-KK	148	2334
PRO-4216-46-CC	163	2032
PRO-4216-51-BB	183	3668
PRO-4216-51-CC	183	2445
PRO-4216-51-CF	183	2445
PRO-4216-51-KK	183	3179
PRO-4216-66-CC	211	1600
PRO-4216-66-KK	211	2080
PRO-4225-05-CC	99	2369
PRO-4226-46-BB	163	3398
PRO-4226-46-CC	163	2265
PRO-4226-46-GG	163	4983
PRO-4226-46-KK	163	2945
PRO-4226-46-LL	163	3398
PRO-4226-46-NN	163	2945
PRO-4226-46-TT	163	3624
PRO-4226-46-VV	163	3624
PRO-4226-46-YY	163	2945
PRO-4226-56-CB	191	2768
PRO-4226-56-CC	191	2768
PRO-4226-56-CF	191	2768

CODE	PAGE	PRICE
PRO-4236-46-BB	163	3660
PRO-4236-46-CC	163	2440
PRO-4236-46-GG	163	5368
PRO-4236-46-KK	163	3172
PRO-4236-46-LL	163	3660
PRO-4236-46-NN	163	3172
PRO-4236-46-TT	163	3904
PRO-4236-46-VV	163	3904
PRO-4236-46-YY	163	3172
PRO-4236-56-CB	192	3132
PRO-4236-56-CC	192	3132
PRO-4236-56-CF	192	3132
PRO-4246-56-CB	192	2975
PRO-4246-56-CC	192	2975
PRO-4246-56-CF	192	2975
PRO-4255-56-CB	192	3075
PRO-4255-56-CC	192	3075
PRO-4255-56-CF	192	3075
PRO-4291-51-BB	183	3563
PRO-4291-51-CC	183	2375
PRO-4291-51-CF	183	2375
PRO-4291-51-KK	183	3088
PRO-4291-80-BB	288	2691
PRO-4291-80-CC	288	1794
PRO-4291-80-GG	288	3947
PRO-4291-80-KK	288	2332
PRO-4291-80-LL	288	2691
PRO-4291-80-NN	288	2332
PRO-4291-80-TT	288	2870
PRO-4291-80-VV	288	2870
PRO-4291-80-YY	288	2332
PRO-4292-80-BB	289	2790
PRO-4292-80-CC	289	1860
PRO-4292-80-GG	289	4092
PRO-4292-80-KK	289	2418
PRO-4292-80-LL	289	2790
PRO-4292-80-NN	289	2418
PRO-4292-80-TT	289	2976
PRO-4292-80-VV	289	2976
PRO-4292-80-YY	289	2418
PRO-4296-04-BB	83	2636
PRO-4296-04-CC	83	1757
PRO-4296-04-GG	83	3865
PRO-4296-04-KK	83	2284
PRO-4296-04-LL	83	2636
PRO-4296-04-NN	83	2284
PRO-4296-04-TT	83	2811
PRO-4296-04-VV	83	2811
PRO-4296-04-YY	83	2284
PRO-4296-05-BB	100	2931
PRO-4296-05-CC	100	1954
PRO-4296-05-GG	100	4299
PRO-4296-05-KK	100	2540
PRO-4296-05-LL	100	2931
PRO-4296-05-NN	100	2540
PRO-4296-05-TT	100	3126
PRO-4296-05-VV	100	3126
PRO-4296-05-YY	100	2540

CODE	PAGE	PRICE
PRO-4296-46-BB	164	2834
PRO-4296-46-CC	164	1889
PRO-4296-46-GG	164	4156
PRO-4296-46-KK	164	2456
PRO-4296-46-LL	164	2834
PRO-4296-46-NN	164	2456
PRO-4296-46-TT	164	3022
PRO-4296-46-VV	164	3022
PRO-4296-46-YY	164	2456
PRO-4296-56-CB	193	2195
PRO-4296-56-CC	193	2195
PRO-4296-56-CF	193	2195
PRO-4297-45-BB	148	2543
PRO-4297-45-CC	148	1695
PRO-4297-45-GG	148	3729
PRO-4297-45-KK	148	2204
PRO-4297-45-LL	148	2543
PRO-4297-45-NN	148	2204
PRO-4297-45-TT	148	2712
PRO-4297-45-VV	148	2712
PRO-4297-45-YY	148	2204
PRO-4297-66-BB	212	2453
PRO-4297-66-CC	212	1635
PRO-4297-66-GG	212	3597
PRO-4297-66-KK	212	2126
PRO-4297-66-LL	212	2453
PRO-4297-66-NN	212	2126
PRO-4297-66-TT	212	2616
PRO-4297-66-VV	212	2616
PRO-4297-66-YY	212	2126
PRO-4301-80-BB	290	3473
PRO-4301-80-CC	290	2315
PRO-4301-80-GG	290	5093
PRO-4301-80-KK	290	3010
PRO-4301-80-LL	290	3473
PRO-4301-80-NN	290	3010
PRO-4301-80-TT	290	3704
PRO-4301-80-VV	290	3704
PRO-4301-80-YY	290	3010
PRO-4302-66-BB	212	3239
PRO-4302-66-CC	212	2159
PRO-4302-66-GG	212	4750
PRO-4302-66-KK	212	2807
PRO-4302-66-LL	212	3239
PRO-4302-66-NN	212	2807
PRO-4302-66-TT	212	3454
PRO-4302-66-VV	212	3454
PRO-4302-66-YY	212	2807
PRO-4302-80-BB	291	3570
PRO-4302-80-CC	291	2380
PRO-4302-80-GG	291	5236
PRO-4302-80-KK	291	3094
PRO-4302-80-LL	291	3570
PRO-4302-80-NN	291	3094
PRO-4302-80-TT	291	3808
PRO-4302-80-VV	291	3808
PRO-4302-80-YY	291	3094
PRO-4305-04-BB	83	3741

Actual products may differ from pictures. Actual products measures may differ from the measures shown. All USD prices are subject to change without notice. Effective as of August 2023.

PRICE INDEX

CODE	PAGE	PRICE
PRO-4305-04-CC	83	2494
PRO-4305-04-GG	83	5487
PRO-4305-04-KK	83	3242
PRO-4305-04-KM	83	3990
PRO-4305-04-LL	83	3741
PRO-4305-04-NN	83	3242
PRO-4305-04-TT	83	3990
PRO-4305-04-VV	83	3990
PRO-4305-04-YY	83	3242
PRO-4306-05-BB	100	3780
PRO-4306-05-CC	100	2520
PRO-4306-05-GG	100	5544
PRO-4306-05-KK	100	3276
PRO-4306-05-LL	100	3780
PRO-4306-05-NN	100	3276
PRO-4306-05-TT	100	4032
PRO-4306-05-VV	100	4032
PRO-4306-05-YY	100	3276
PRO-4306-45-BB	148	3630
PRO-4306-45-CC	148	2420
PRO-4306-45-GG	148	5324
PRO-4306-45-KK	148	3146
PRO-4306-45-LL	148	3630
PRO-4306-45-NN	148	3146
PRO-4306-45-TT	148	3872
PRO-4306-45-VV	148	3872
PRO-4306-45-YY	148	3146
PRO-4306-46-BB	164	3929
PRO-4306-46-CC	164	2619
PRO-4306-46-GG	164	5762
PRO-4306-46-KK	164	3405
PRO-4306-46-LL	164	3929
PRO-4306-46-NN	164	3405
PRO-4306-46-TT	164	4190
PRO-4306-46-VV	164	4190
PRO-4306-46-YY	164	3405
PRO-4306-66-BB	212	3090
PRO-4306-66-CC	212	2060
PRO-4306-66-GG	212	4532
PRO-4306-66-KK	212	2678
PRO-4306-66-LL	212	3090
PRO-4306-66-NN	212	2678
PRO-4306-66-TT	212	3296
PRO-4306-66-VV	212	3296
PRO-4306-66-YY	212	2678
PRO-4316-04-CC	84	2645
PRO-4316-04-KK	84	3439
PRO-4316-66-CC	213	1895
PRO-4316-66-KK	213	2464
PRO-4326-56-CB	193	3288
PRO-4326-56-CC	193	3288
PRO-4326-56-CF	193	3288
PRO-4394-66-BB	213	3852
PRO-4394-66-CC	213	2568
PRO-4394-66-GG	213	5650
PRO-4394-66-KK	213	3338
PRO-4394-66-LL	213	3852
PRO-4394-66-NN	213	3338

CODE	PAGE	PRICE
PRO-4394-66-TT	213	4109
PRO-4394-66-VV	213	4109
PRO-4394-66-YY	213	3338
PRO-4395-05-BB	100	4613
PRO-4395-05-CC	100	3075
PRO-4395-05-GG	100	6765
PRO-4395-05-KK	100	3998
PRO-4395-05-LL	100	4613
PRO-4395-05-NN	100	3998
PRO-4395-05-TT	100	4920
PRO-4395-05-VV	100	4920
PRO-4395-05-YY	100	3998
PRR-2800-14-BB	107	2738
PRR-2800-14-CC	107	1825
PRR-2800-14-GG	107	4015
PRR-2800-14-KK	107	2373
PRR-2800-14-LL	107	2738
PRR-2800-14-NN	107	2373
PRR-2800-14-TT	107	2920
PRR-2800-14-VV	107	2920
PRR-2800-14-YY	107	2373
PRR-2801-80-BB	270	2588
PRR-2801-80-CC	270	1725
PRR-2801-80-GG	270	3795
PRR-2801-80-KK	270	2243
PRR-2801-80-LL	270	2588
PRR-2801-80-NN	270	2243
PRR-2801-80-TT	270	2760
PRR-2801-80-VV	270	2760
PRR-2801-80-YY	270	2243
PRR-2802-80-BB	271	2603
PRR-2802-80-CC	271	1735
PRR-2802-80-GG	271	3817
PRR-2802-80-KK	271	2256
PRR-2802-80-LL	271	2603
PRR-2802-80-NN	271	2256
PRR-2802-80-TT	271	2776
PRR-2802-80-VV	271	2776
PRR-2802-80-YY	271	2256
PRR-2805-04-BB	80	2697
PRR-2805-04-CC	80	1798
PRR-2805-04-GG	80	3956
PRR-2805-04-KK	80	2337
PRR-2805-04-LL	80	2697
PRR-2805-04-NN	80	2337
PRR-2805-04-TT	80	2877
PRR-2805-04-VV	80	2877
PRR-2805-04-YY	80	2337
PRR-2805-45-BB	145	2697
PRR-2805-45-CC	145	1798
PRR-2805-45-GG	145	3956
PRR-2805-45-KK	145	2337
PRR-2805-45-LL	145	2697
PRR-2805-45-NN	145	2337
PRR-2805-45-TT	145	2877
PRR-2805-45-VV	145	2877
PRR-2805-45-YY	145	2337
PRR-2805-66-BB	208	2397

CODE	PAGE	PRICE
PRR-2805-66-CC	208	1598
PRR-2805-66-GG	208	3516
PRR-2805-66-KK	208	2077
PRR-2805-66-LL	208	2397
PRR-2805-66-NN	208	2077
PRR-2805-66-TT	208	2557
PRR-2805-66-VV	208	2557
PRR-2805-66-YY	208	2077
PRR-2805-95-BB	97	2984
PRR-2805-95-CC	97	1989
PRR-2805-95-GG	97	4376
PRR-2805-95-KK	97	2586
PRR-2805-95-LL	97	2984
PRR-2805-95-NN	97	2586
PRR-2805-95-TT	97	3182
PRR-2805-95-VV	97	3182
PRR-2805-95-YY	97	2586
PRR-2811-80-CC	272	1795
PRR-2811-80-KK	272	2334
PRR-2812-80-CC	273	1825
PRR-2812-80-KK	273	2373
PRR-2815-04-CC	80	1883
PRR-2815-04-KK	80	2448
PRR-2815-45-CC	146	1545
PRR-2815-45-KK	146	2009
PRR-2815-46-CC	161	1595
PRR-2815-46-KK	161	2074
PRR-2815-66-CC	208	1495
PRR-2815-95-CC	98	1695
PRR-2816-66-CC	209	1345
PRR-2816-66-KK	209	1749
PRR-2826-66-CC	209	1495
PRR-2826-66-KK	209	1944
PRR-2891-80-BB	274	2243
PRR-2891-80-CC	274	1495
PRR-2891-80-GG	274	3289
PRR-2891-80-KK	274	1944
PRR-2891-80-LL	274	2243
PRR-2891-80-NN	274	1944
PRR-2891-80-TT	274	2392
PRR-2891-80-VV	274	2392
PRR-2891-80-YY	274	1944
PRR-2892-80-BB	275	2280
PRR-2892-80-CC	275	1520
PRR-2892-80-GG	275	3344
PRR-2892-80-KK	275	1976
PRR-2892-80-LL	275	2280
PRR-2892-80-NN	275	1976
PRR-2892-80-TT	275	2432
PRR-2892-80-VV	275	2432
PRR-2892-80-YY	275	1976
PRR-2896-04-BB	80	2393
PRR-2896-04-CC	80	1595
PRR-2896-04-GG	80	3509
PRR-2896-04-KK	80	2074
PRR-2896-04-LL	80	2393
PRR-2896-04-NN	80	2074
PRR-2896-04-TT	80	2552

Finishes:

CC = chrome, CD = chrome diamond, CF = smokey chrome, KK = matte black, LL = satin brass, BB = white, NN = brushed nickel, YY = polished nickel, TT = venetian bronze, VV = satin copper, GG = gold, KM = black titanium, CB = chrome white, KB = matte black white, LB = satin brass white, NB = brushed nickel white, YB = polished nickel white, TB = venetian bronze, VB = satin copper white, GB = gold white

PRICE INDEX

CODE	PAGE	PRICE
PRR-2896-04-VV	80	2552
PRR-2896-04-YY	80	2074
PRR-2896-05-BB	98	2489
PRR-2896-05-CC	98	1659
PRR-2896-05-GG	98	3650
PRR-2896-05-KK	98	2157
PRR-2896-05-LL	98	2489
PRR-2896-05-NN	98	2157
PRR-2896-05-TT	98	2654
PRR-2896-05-VV	98	2654
PRR-2896-05-YY	98	2157
PRR-2896-45-BB	146	2363
PRR-2896-45-CC	146	1575
PRR-2896-45-GG	146	3465
PRR-2896-45-KK	146	2048
PRR-2896-45-LL	146	2363
PRR-2896-45-NN	146	2048
PRR-2896-45-TT	146	2520
PRR-2896-45-VV	146	2520
PRR-2896-45-YY	146	2048
PRR-2896-46-BB	161	2393
PRR-2896-46-CC	161	1595
PRR-2896-46-GG	161	3509
PRR-2896-46-KK	161	2074
PRR-2896-46-LL	161	2393
PRR-2896-46-NN	161	2074
PRR-2896-46-TT	161	2552
PRR-2896-46-VV	161	2552
PRR-2896-46-YY	161	2074
PRR-2896-66-BB	209	2288
PRR-2896-66-CC	209	1525
PRR-2896-66-GG	209	3355
PRR-2896-66-KK	209	1983
PRR-2896-66-LL	209	2288
PRR-2896-66-NN	209	1983
PRR-2896-66-TT	209	2440
PRR-2896-66-VV	209	2440
PRR-2896-66-YY	209	1983
PRR-2901-80-CC	276	1975
PRR-2902-80-CC	277	1995
PRR-2915-04-CC	81	2057
PRR-2915-04-KK	81	2674
PRR-2915-45-CC	146	1719
PRR-2915-45-KK	146	2235
PRR-2915-66-CC	210	1675
PRR-3301-80-BB	278	3396
PRR-3301-80-CC	278	2264
PRR-3301-80-GG	278	4981
PRR-3301-80-KK	278	2943
PRR-3301-80-LL	278	3396
PRR-3301-80-NN	278	2943
PRR-3301-80-TT	278	3622
PRR-3301-80-VV	278	3622
PRR-3301-80-YY	278	2943
PRR-3302-04-BB	81	3525
PRR-3302-04-CC	81	2350
PRR-3302-04-GG	81	5170
PRR-3302-04-KK	81	3055

CODE	PAGE	PRICE
PRR-3302-04-LL	81	3525
PRR-3302-04-NN	81	3055
PRR-3302-04-TT	81	3760
PRR-3302-04-VV	81	3760
PRR-3302-04-YY	81	3055
PRR-3302-45-BB	147	3653
PRR-3302-45-CC	147	2435
PRR-3302-45-GG	147	5357
PRR-3302-45-KK	147	3166
PRR-3302-45-LL	147	3653
PRR-3302-45-NN	147	3166
PRR-3302-45-TT	147	3896
PRR-3302-45-VV	147	3896
PRR-3302-45-YY	147	3166
PRR-3302-46-BB	162	3443
PRR-3302-46-CC	162	2295
PRR-3302-46-GG	162	5049
PRR-3302-46-KK	162	2984
PRR-3302-46-LL	162	3443
PRR-3302-46-NN	162	2984
PRR-3302-46-TT	162	3672
PRR-3302-46-VV	162	3672
PRR-3302-46-YY	162	2984
PRR-3302-47-Bx	175	4793
PRR-3302-47-Cx	175	3195
PRR-3302-47-Gx	175	7029
PRR-3302-47-Kx	175	4154
PRR-3302-47-Lx	175	4793
PRR-3302-47-Nx	175	4154
PRR-3302-47-Tx	175	5112
PRR-3302-47-Vx	175	5112
PRR-3302-47-Yx	175	4154
PRR-3302-66-BB	210	3552
PRR-3302-66-CC	210	2368
PRR-3302-66-GG	210	5210
PRR-3302-66-KK	210	3078
PRR-3302-66-LL	210	3552
PRR-3302-66-NN	210	3078
PRR-3302-66-TT	210	3789
PRR-3302-66-VV	210	3789
PRR-3302-66-YY	210	3078
PRR-3302-80-BB	280	3443
PRR-3302-80-CC	280	2295
PRR-3302-80-GG	280	5049
PRR-3302-80-KK	280	2984
PRR-3302-80-LL	280	3443
PRR-3302-80-NN	280	2984
PRR-3302-80-TT	280	3672
PRR-3302-80-VV	280	3672
PRR-3302-80-YY	280	2984
PRR-3303-47-Bx	175	5175
PRR-3303-47-Cx	175	3450
PRR-3303-47-Gx	175	7590
PRR-3303-47-Kx	175	4485
PRR-3303-47-Lx	175	5175
PRR-3303-47-Nx	175	4485
PRR-3303-47-Tx	175	5520
PRR-3303-47-Vx	175	5520

CODE	PAGE	PRICE
PRR-3303-47-Yx	175	4485
PRR-3352-47-Bx	176	4778
PRR-3352-47-Cx	176	3185
PRR-3352-47-Gx	176	7007
PRR-3352-47-Kx	176	4141
PRR-3352-47-Lx	176	4778
PRR-3352-47-Nx	176	4141
PRR-3352-47-Tx	176	5096
PRR-3352-47-Vx	176	5096
PRR-3352-47-Yx	176	4141
PRR-3405-04-BB	81	3659
PRR-3405-04-CC	81	2439
PRR-3405-04-GG	81	5366
PRR-3405-04-KK	81	3171
PRR-3405-04-LL	81	3659
PRR-3405-04-NN	81	3171
PRR-3405-04-TT	81	3902
PRR-3405-04-VV	81	3902
PRR-3405-04-YY	81	3171
PRR-3405-05-BB	98	4118
PRR-3405-05-CC	98	2745
PRR-3405-05-GG	98	6039
PRR-3405-05-KK	98	3569
PRR-3405-05-LL	98	4118
PRR-3405-05-NN	98	3569
PRR-3405-05-TT	98	4392
PRR-3405-05-VV	98	4392
PRR-3405-05-YY	98	3569
PRR-3405-45-BB	147	3743
PRR-3405-45-CC	147	2495
PRR-3405-45-GG	147	5489
PRR-3405-45-KK	147	3244
PRR-3405-45-LL	147	3743
PRR-3405-45-NN	147	3244
PRR-3405-45-TT	147	3992
PRR-3405-45-VV	147	3992
PRR-3405-45-YY	147	3244
PRR-3405-66-BB	210	3443
PRR-3405-66-CC	210	2295
PRR-3405-66-GG	210	5049
PRR-3405-66-KK	210	2984
PRR-3405-66-LL	210	3443
PRR-3405-66-NN	210	2984
PRR-3405-66-TT	210	3672
PRR-3405-66-VV	210	3672
PRR-3405-66-YY	210	2984
PRR-3420-16-BB	115	3518
PRR-3420-16-CC	115	2345
PRR-3420-16-GG	115	5159
PRR-3420-16-KK	115	3049
PRR-3420-16-LL	115	3518
PRR-3420-16-NN	115	3049
PRR-3420-16-TT	115	3752
PRR-3420-16-VV	115	3752
PRR-3420-16-YY	115	3049
PRR-3420-18-BB	116	3518
PRR-3420-18-CB	116	2345
PRR-3420-18-CC	116	2345

Actual products may differ from pictures. Actual products measures may differ from the measures shown. All USD prices are subject to change without notice. Effective as of August 2023.

PRICE INDEX

CODE	PAGE	PRICE
PRR-3420-18-GB	116	5159
PRR-3420-18-GG	116	5159
PRR-3420-18-KB	116	3049
PRR-3420-18-KK	116	3049
PRR-3420-18-LB	116	3518
PRR-3420-18-LL	116	3518
PRR-3420-18-NB	116	3049
PRR-3420-18-NN	116	3049
PRR-3420-18-TB	116	3752
PRR-3420-18-TT	116	3752
PRR-3420-18-VB	116	3752
PRR-3420-18-VV	116	3752
PRR-3420-18-YB	116	3049
PRR-3420-18-YY	116	3049
PRR-3420-26-CD	123	3795
PRR-3420-27-BB	124	4380
PRR-3420-27-CC	124	2920
PRR-3420-27-GG	124	6424
PRR-3420-27-KK	124	3796
PRR-3420-27-LL	124	4380
PRR-3420-27-NN	124	3796
PRR-3420-27-TT	124	4672
PRR-3420-27-VV	124	4672
PRR-3420-27-YY	124	3796
PRR-3420-28-BB	124	4380
PRR-3420-28-CC	124	2920
PRR-3420-28-GG	124	6424
PRR-3420-28-KK	124	3796
PRR-3420-28-LL	124	4380
PRR-3420-28-NN	124	3796
PRR-3420-28-TT	124	4672
PRR-3420-28-VV	124	4672
PRR-3420-28-YY	124	3796
PRR-3420-71-BB	221	4125
PRR-3420-71-CC	221	2750
PRR-3420-71-GG	221	6050
PRR-3420-71-KK	221	3575
PRR-3420-71-LL	221	4125
PRR-3420-71-NN	221	3575
PRR-3420-71-TT	221	4400
PRR-3420-71-VV	221	4400
PRR-3420-71-YY	221	3575
PRR-3420-72-BB	222	4125
PRR-3420-72-CC	222	2750
PRR-3420-72-GG	222	6050
PRR-3420-72-KK	222	3575
PRR-3420-72-LL	222	4125
PRR-3420-72-NN	222	3575
PRR-3420-72-TT	222	4400
PRR-3420-72-VV	222	4400
PRR-3420-72-YY	222	3575
PRR-3420-74-BB	229	4125
PRR-3420-74-CB	229	2750
PRR-3420-74-GB	229	6050
PRR-3420-74-KB	229	3575
PRR-3420-74-LB	229	4125
PRR-3420-74-NB	229	3575
PRR-3420-74-TB	229	4400

CODE	PAGE	PRICE
PRR-3420-74-VB	229	4400
PRR-3420-74-YB	229	3575
PRR-3950-04-BB	82	5693
PRR-3950-04-CC	82	3795
PRR-3950-04-GG	82	8349
PRR-3950-04-KK	82	4934
PRR-3950-04-LL	82	5693
PRR-3950-04-NN	82	4934
PRR-3950-04-TT	82	6072
PRR-3950-04-VV	82	6072
PRR-3950-04-YY	82	4934
PRR-3950-46-BB	162	6428
PRR-3950-46-CC	162	4285
PRR-3950-46-GG	162	9427
PRR-3950-46-KK	162	5571
PRR-3950-46-LL	162	6428
PRR-3950-46-NN	162	5571
PRR-3950-46-TT	162	6856
PRR-3950-46-VV	162	6856
PRR-3950-46-YY	162	5571
PRR-3950-56-CB	191	5075
PRR-3950-56-CC	191	5075
PRR-3950-56-CF	191	5075
PRR-4201-66-BB	211	2835
PRR-4201-66-CC	211	1890
PRR-4201-66-GG	211	4158
PRR-4201-66-KK	211	2457
PRR-4201-66-LL	211	2835
PRR-4201-66-NN	211	2457
PRR-4201-66-TT	211	3024
PRR-4201-66-VV	211	3024
PRR-4201-66-YY	211	2457
PRR-4201-80-BB	284	3068
PRR-4201-80-CC	284	2045
PRR-4201-80-GG	284	4499
PRR-4201-80-KK	284	2659
PRR-4201-80-LL	284	3068
PRR-4201-80-NN	284	2659
PRR-4201-80-TT	284	3272
PRR-4201-80-VV	284	3272
PRR-4201-80-YY	284	2659
PRR-4202-80-BB	285	3165
PRR-4202-80-CC	285	2110
PRR-4202-80-GG	285	4642
PRR-4202-80-KK	285	2743
PRR-4202-80-LL	285	3165
PRR-4202-80-NN	285	2743
PRR-4202-80-TT	285	3376
PRR-4202-80-VV	285	3376
PRR-4202-80-YY	285	2743
PRR-4205-04-BB	82	3015
PRR-4205-04-CC	82	2010
PRR-4205-04-GG	82	4422
PRR-4205-04-KK	82	2613
PRR-4205-04-KM	82	3216
PRR-4205-04-LL	82	3015
PRR-4205-04-NN	82	2613
PRR-4205-04-TT	82	3216

CODE	PAGE	PRICE
PRR-4205-04-VV	82	3216
PRR-4205-04-YY	82	2613
PRR-4206-05-BB	99	3165
PRR-4206-05-CC	99	2110
PRR-4206-05-GG	99	4642
PRR-4206-05-KK	99	2743
PRR-4206-05-LL	99	3165
PRR-4206-05-NN	99	2743
PRR-4206-05-TT	99	3376
PRR-4206-05-VV	99	3376
PRR-4206-05-YY	99	2743
PRR-4206-45-BB	147	2918
PRR-4206-45-CC	147	1945
PRR-4206-45-GG	147	4279
PRR-4206-45-KK	147	2529
PRR-4206-45-LL	147	2918
PRR-4206-45-NN	147	2529
PRR-4206-45-TT	147	3112
PRR-4206-45-VV	147	3112
PRR-4206-45-YY	147	2529
PRR-4206-46-BB	162	3203
PRR-4206-46-CC	162	2135
PRR-4206-46-GG	162	4697
PRR-4206-46-KK	162	2776
PRR-4206-46-LL	162	3203
PRR-4206-46-NN	162	2776
PRR-4206-46-TT	162	3416
PRR-4206-46-VV	162	3416
PRR-4206-46-YY	162	2776
PRR-4206-66-BB	211	2685
PRR-4206-66-CC	211	1790
PRR-4206-66-GG	211	3938
PRR-4206-66-KK	211	2327
PRR-4206-66-LL	211	2685
PRR-4206-66-NN	211	2327
PRR-4206-66-TT	211	2864
PRR-4206-66-VV	211	2864
PRR-4206-66-YY	211	2327
PRR-4211-80-CC	286	2075
PRR-4211-80-KK	286	2698
PRR-4212-80-CC	287	2125
PRR-4212-80-KK	287	2763
PRR-4215-04-CC	82	2125
PRR-4215-04-KK	82	2763
PRR-4216-05-CC	99	2225
PRR-4216-05-KK	99	2893
PRR-4216-45-CC	148	1795
PRR-4216-45-KK	148	2334
PRR-4216-46-CC	163	2032
PRR-4216-51-BB	183	3668
PRR-4216-51-CC	183	2445
PRR-4216-51-CF	183	2445
PRR-4216-51-KK	183	3179
PRR-4216-66-CC	211	1600
PRR-4216-66-KK	211	2080
PRR-4225-05-CC	99	2369
PRR-4226-46-BB	163	3398
PRR-4226-46-CC	163	2265

Finishes:

CC = chrome, CD = chrome diamond, CF = smokey chrome, KK = matte black, LL = satin brass, BB = white, NN = brushed nickel, YY = polished nickel, TT = venetian bronze, VV = satin copper, GG = gold, KM = black titanium, CB = chrome white, KB = matte black white, LB = satin brass white, NB = brushed nickel white, YB = polished nickel white, TB = venetian bronze, VB = satin copper white, GB = gold white

PRICE INDEX

CODE	PAGE	PRICE
PRR-4226-46-GG	163	4983
PRR-4226-46-KK	163	2945
PRR-4226-46-LL	163	3398
PRR-4226-46-NN	163	2945
PRR-4226-46-TT	163	3624
PRR-4226-46-VV	163	3624
PRR-4226-46-YY	163	2945
PRR-4226-56-CB	191	2768
PRR-4226-56-CC	191	2768
PRR-4226-56-CF	191	2768
PRR-4236-56-CB	192	3132
PRR-4236-56-CC	192	3132
PRR-4236-56-CF	192	3132
PRR-4255-56-CB	192	3075
PRR-4255-56-CC	192	3075
PRR-4255-56-CF	192	3075
PRR-4291-51-BB	183	3563
PRR-4291-51-CC	183	2375
PRR-4291-51-CF	183	2375
PRR-4291-51-KK	183	3088
PRR-4291-80-BB	288	2691
PRR-4291-80-CC	288	1794
PRR-4291-80-GG	288	3947
PRR-4291-80-KK	288	2332
PRR-4291-80-LL	288	2691
PRR-4291-80-NN	288	2332
PRR-4291-80-TT	288	2870
PRR-4291-80-VV	288	2870
PRR-4291-80-YY	288	2332
PRR-4292-80-BB	289	2790
PRR-4292-80-CC	289	1860
PRR-4292-80-GG	289	4092
PRR-4292-80-KK	289	2418
PRR-4292-80-LL	289	2790
PRR-4292-80-NN	289	2418
PRR-4292-80-TT	289	2976
PRR-4292-80-VV	289	2976
PRR-4292-80-YY	289	2418
PRR-4296-04-BB	83	2636
PRR-4296-04-CC	83	1757
PRR-4296-04-GG	83	3865
PRR-4296-04-KK	83	2284
PRR-4296-04-LL	83	2636
PRR-4296-04-NN	83	2284
PRR-4296-04-TT	83	2811
PRR-4296-04-VV	83	2811
PRR-4296-04-YY	83	2284
PRR-4296-05-BB	100	2931
PRR-4296-05-CC	100	1954
PRR-4296-05-GG	100	4299
PRR-4296-05-KK	100	2540
PRR-4296-05-LL	100	2931
PRR-4296-05-NN	100	2540
PRR-4296-05-TT	100	3126
PRR-4296-05-VV	100	3126
PRR-4296-05-YY	100	2540
PRR-4296-46-BB	164	2834
PRR-4296-46-CC	164	1889

CODE	PAGE	PRICE
PRR-4296-46-GG	164	4156
PRR-4296-46-KK	164	2456
PRR-4296-46-LL	164	2834
PRR-4296-46-NN	164	2456
PRR-4296-46-TT	164	3022
PRR-4296-46-VV	164	3022
PRR-4296-46-YY	164	2456
PRR-4296-56-CB	193	2195
PRR-4296-56-CC	193	2195
PRR-4296-56-CF	193	2195
PRR-4297-45-BB	148	2543
PRR-4297-45-CC	148	1695
PRR-4297-45-GG	148	3729
PRR-4297-45-KK	148	2204
PRR-4297-45-LL	148	2543
PRR-4297-45-NN	148	2204
PRR-4297-45-TT	148	2712
PRR-4297-45-VV	148	2712
PRR-4297-45-YY	148	2204
PRR-4297-66-BB	212	2453
PRR-4297-66-CC	212	1635
PRR-4297-66-GG	212	3597
PRR-4297-66-KK	212	2126
PRR-4297-66-LL	212	2453
PRR-4297-66-NN	212	2126
PRR-4297-66-TT	212	2616
PRR-4297-66-VV	212	2616
PRR-4297-66-YY	212	2126
PRR-4301-80-BB	290	3473
PRR-4301-80-CC	290	2315
PRR-4301-80-GG	290	5093
PRR-4301-80-KK	290	3010
PRR-4301-80-LL	290	3473
PRR-4301-80-NN	290	3010
PRR-4301-80-TT	290	3704
PRR-4301-80-VV	290	3704
PRR-4301-80-YY	290	3010
PRR-4302-66-BB	212	3239
PRR-4302-66-CC	212	2159
PRR-4302-66-GG	212	4750
PRR-4302-66-KK	212	2807
PRR-4302-66-LL	212	3239
PRR-4302-66-NN	212	2807
PRR-4302-66-TT	212	3454
PRR-4302-66-VV	212	3454
PRR-4302-66-YY	212	2807
PRR-4302-80-BB	291	3570
PRR-4302-80-CC	291	2380
PRR-4302-80-GG	291	5236
PRR-4302-80-KK	291	3094
PRR-4302-80-LL	291	3570
PRR-4302-80-NN	291	3094
PRR-4302-80-TT	291	3808
PRR-4302-80-VV	291	3808
PRR-4302-80-YY	291	3094
PRR-4305-04-BB	83	3741
PRR-4305-04-CC	83	2494
PRR-4305-04-GG	83	5487

CODE	PAGE	PRICE
PRR-4305-04-KK	83	3242
PRR-4305-04-KM	83	3990
PRR-4305-04-LL	83	3741
PRR-4305-04-NN	83	3242
PRR-4305-04-TT	83	3990
PRR-4305-04-VV	83	3990
PRR-4305-04-YY	83	3242
PRR-4306-05-BB	100	3780
PRR-4306-05-CC	100	2520
PRR-4306-05-GG	100	5544
PRR-4306-05-KK	100	3276
PRR-4306-05-LL	100	3780
PRR-4306-05-NN	100	3276
PRR-4306-05-TT	100	4032
PRR-4306-05-VV	100	4032
PRR-4306-05-YY	100	3276
PRR-4306-45-BB	148	3630
PRR-4306-45-CC	148	2420
PRR-4306-45-GG	148	5324
PRR-4306-45-KK	148	3146
PRR-4306-45-LL	148	3630
PRR-4306-45-NN	148	3146
PRR-4306-45-TT	148	3872
PRR-4306-45-VV	148	3872
PRR-4306-45-YY	148	3146
PRR-4306-46-BB	164	3929
PRR-4306-46-CC	164	2619
PRR-4306-46-GG	164	5762
PRR-4306-46-KK	164	3405
PRR-4306-46-LL	164	3929
PRR-4306-46-NN	164	3405
PRR-4306-46-TT	164	4190
PRR-4306-46-VV	164	4190
PRR-4306-46-YY	164	3405
PRR-4306-66-BB	212	3090
PRR-4306-66-CC	212	2060
PRR-4306-66-GG	212	4532
PRR-4306-66-KK	212	2678
PRR-4306-66-LL	212	3090
PRR-4306-66-NN	212	2678
PRR-4306-66-TT	212	3296
PRR-4306-66-VV	212	3296
PRR-4306-66-YY	212	2678
PRR-4316-04-CC	84	2645
PRR-4316-04-KK	84	3439
PRR-4316-66-CC	213	1895
PRR-4316-66-KK	213	2464
PRR-4326-56-CB	193	3288
PRR-4326-56-CC	193	3288
PRR-4326-56-CF	193	3288
PRR-4394-66-BB	213	3852
PRR-4394-66-CC	213	2568
PRR-4394-66-GG	213	5650
PRR-4394-66-KK	213	3338
PRR-4394-66-LL	213	3852
PRR-4394-66-NN	213	3338
PRR-4394-66-TT	213	4109
PRR-4394-66-VV	213	4109

Actual products may differ from pictures. Actual products measures may differ from the measures shown. All USD prices are subject to change without notice. Effective as of August 2023.

PRICE INDEX

CODE	PAGE	PRICE
PRR-4394-66-YY	213	3338
PRR-4395-05-BB	100	4613
PRR-4395-05-CC	100	3075
PRR-4395-05-GG	100	6765
PRR-4395-05-KK	100	3998
PRR-4395-05-LL	100	4613
PRR-4395-05-NN	100	3998
PRR-4395-05-TT	100	4920
PRR-4395-05-VV	100	4920
PRR-4395-05-YY	100	3998
RAC-0318-02-BB	375	87
RAC-0318-02-CC	375	58
RAC-0318-02-GG	375	145
RAC-0318-02-KK	375	75
RAC-0318-02-LL	375	87
RAC-0318-02-NN	375	75
RAC-0318-02-TT	375	93
RAC-0318-02-VV	375	93
RAC-0318-02-YY	375	75
RAC-0318-14-BB	375	147
RAC-0318-14-CC	375	98
RAC-0318-14-GG	375	216
RAC-0318-14-KK	375	127
RAC-0318-14-LL	375	147
RAC-0318-14-NN	375	127
RAC-0318-14-TT	375	157
RAC-0318-14-VV	375	157
RAC-0318-14-YY	375	127
RAC-0618-02-BB	375	102
RAC-0618-02-CC	375	68
RAC-0618-02-GG	375	170
RAC-0618-02-KK	375	88
RAC-0618-02-KM	375	109
RAC-0618-02-LL	375	102
RAC-0618-02-NN	375	88
RAC-0618-02-TT	375	109
RAC-0618-02-VV	375	109
RAC-0618-02-YY	375	88
RAC-0618-14-BB	375	162
RAC-0618-14-CC	375	108
RAC-0618-14-GG	375	238
RAC-0618-14-KK	375	140
RAC-0618-14-LL	375	162
RAC-0618-14-NN	375	140
RAC-0618-14-TT	375	173
RAC-0618-14-VV	375	173
RAC-0618-14-YY	375	140
RAC-0918-02-BB	375	149
RAC-0918-02-CC	375	99
RAC-0918-02-GG	375	218
RAC-0918-02-KK	375	129
RAC-0918-02-LL	375	149
RAC-0918-02-NN	375	129
RAC-0918-02-TT	375	158
RAC-0918-02-VV	375	158
RAC-0918-02-YY	375	129
RAC-0918-14-BB	376	224
RAC-0918-14-CC	376	149

CODE	PAGE	PRICE
RAC-0918-14-GG	376	328
RAC-0918-14-KK	376	194
RAC-0918-14-LL	376	224
RAC-0918-14-NN	376	194
RAC-0918-14-TT	376	238
RAC-0918-14-VV	376	238
RAC-0918-14-YY	376	194
RAC-1218-02-BB	376	201
RAC-1218-02-CC	376	134
RAC-1218-02-GG	376	295
RAC-1218-02-KK	376	174
RAC-1218-02-LL	376	201
RAC-1218-02-NN	376	174
RAC-1218-02-TT	376	214
RAC-1218-02-VV	376	214
RAC-1218-02-YY	376	174
RAC-1218-14-BB	376	261
RAC-1218-14-CC	376	174
RAC-1218-14-GG	376	383
RAC-1218-14-KK	376	226
RAC-1218-14-LL	376	261
RAC-1218-14-NN	376	226
RAC-1218-14-TT	376	278
RAC-1218-14-VV	376	278
RAC-1218-14-YY	376	226
RAC-9001-13-BB	365	132
RAC-9001-13-CC	365	88
RAC-9001-13-GG	365	194
RAC-9001-13-KK	365	114
RAC-9001-13-LL	365	132
RAC-9001-13-NN	365	114
RAC-9001-13-TT	365	141
RAC-9001-13-VV	365	141
RAC-9001-13-YY	365	114
RAC-9001-16-BB	365	186
RAC-9001-16-CC	365	124
RAC-9001-16-GG	365	273
RAC-9001-16-KK	365	161
RAC-9001-16-KM	365	198
RAC-9001-16-LL	365	186
RAC-9001-16-NN	365	161
RAC-9001-16-TT	365	198
RAC-9001-16-VV	365	198
RAC-9001-16-YY	365	161
RAC-9001-18-BB	365	216
RAC-9001-18-CC	365	144
RAC-9001-18-GG	365	317
RAC-9001-18-KK	365	187
RAC-9001-18-LL	365	216
RAC-9001-18-NN	365	187
RAC-9001-18-TT	365	230
RAC-9001-18-VV	365	230
RAC-9001-18-YY	365	187
RAC-9001-19-BB	365	261
RAC-9001-19-CC	365	174
RAC-9001-19-GG	365	383
RAC-9001-19-KK	365	226
RAC-9001-19-LL	365	261

CODE	PAGE	PRICE
RAC-9001-19-NN	365	226
RAC-9001-19-TT	365	278
RAC-9001-19-VV	365	278
RAC-9001-19-YY	365	226
RAC-9001-20-BB	365	333
RAC-9001-20-CC	365	222
RAC-9001-20-GG	365	488
RAC-9001-20-KK	365	289
RAC-9001-20-LL	365	333
RAC-9001-20-NN	365	289
RAC-9001-20-TT	365	355
RAC-9001-20-VV	365	355
RAC-9001-20-YY	365	289
RAC-9001-21-Bx	365	517
RAC-9001-21-Cx	365	323
RAC-9001-21-Gx	365	743
RAC-9001-21-Kx	365	420
RAC-9001-21-Lx	365	517
RAC-9001-21-Nx	365	420
RAC-9001-21-Tx	365	517
RAC-9001-21-Vx	365	517
RAC-9001-21-Yx	365	420
RAC-9001-26-CC	366	60
RAC-9001-26-KK	366	78
RAC-9001-28-CC	366	66
RAC-9001-28-KK	366	86
RAC-9001-35-II	133	1095
RAC-9001-35-KK	133	1095
RAC-9201-02-BB	342	299
RAC-9201-02-CC	342	199
RAC-9201-02-GG	342	438
RAC-9201-02-KK	342	259
RAC-9201-02-LL	342	299
RAC-9201-02-NN	342	259
RAC-9201-02-TT	342	318
RAC-9201-02-VV	342	318
RAC-9201-02-YY	342	259
RAC-9402-14-BB	342	336
RAC-9402-14-CC	342	224
RAC-9402-14-GG	342	493
RAC-9402-14-KK	342	291
RAC-9402-14-LL	342	336
RAC-9402-14-NN	342	291
RAC-9402-14-TT	342	358
RAC-9402-14-VV	342	358
RAC-9402-14-YY	342	291
REN-0020-01-BB	309	135
REN-0020-01-CC	309	90
REN-0020-01-GG	309	198
REN-0020-01-KK	309	117
REN-0020-01-LL	309	135
REN-0020-01-NN	309	117
REN-0020-01-TT	309	144
REN-0020-01-VV	309	144
REN-0020-01-YY	309	117
REN-2007-10-BB	309	607
REN-2007-10-CC	309	404
REN-2007-10-GG	309	890

Finishes:

CC = chrome, CD = chrome diamond, CF = smokey chrome, KK = matte black, LL = satin brass, BB = white, NN = brushed nickel, YY = polished nickel, TT = venetian bronze, VV = satin copper, GG = gold, KM = black titanium, CB = chrome white, KB = matte black white, LB = satin brass white, NB = brushed nickel white, YB = polished nickel white, TB = venetian bronze, VB = satin copper white, GB = gold white

PRICE INDEX

CODE	PAGE	PRICE
REN-2007-10-KK	309	526
REN-2007-10-LL	309	607
REN-2007-10-NN	309	526
REN-2007-10-TT	309	647
REN-2007-10-VV	309	647
REN-2007-10-YY	309	526
REN-2008-14-BB	309	607
REN-2008-14-CC	309	404
REN-2008-14-GG	309	890
REN-2008-14-KK	309	526
REN-2008-14-KM	309	647
REN-2008-14-LL	309	607
REN-2008-14-NN	309	526
REN-2008-14-TT	309	647
REN-2008-14-VV	309	647
REN-2008-14-YY	309	526
REN-2018-27-BB	309	876
REN-2018-27-CC	309	584
REN-2018-27-GG	309	1285
REN-2018-27-KK	309	759
REN-2018-27-LL	309	876
REN-2018-27-NN	309	759
REN-2018-27-TT	309	934
REN-2018-27-VV	309	934
REN-2018-27-YY	309	759
REN-6035-01-CC	63	115
REN-6035-01-KK	63	150
REN-6035-01-KM	63	184
REN-6035-01-LL	63	173
REN-6035-01-SS	63	150
REN-8402-02-CC	309	120
REN-8403-02-CC	310	120
REN-8416-02-CC	310	81
REN-8417-02-CC	310	75
REN-8422-02-BB	310	217
REN-8422-02-CC	310	144
REN-8422-02-GG	310	332
REN-8422-02-II	310	222
REN-8422-02-JJ	310	222
REN-8422-02-KK	310	188
REN-8422-02-KM	310	231
REN-8422-02-LL	310	217
REN-8422-02-NN	310	188
REN-8422-02-TT	310	231
REN-8422-02-VV	310	231
REN-8422-02-YY	310	188
REN-8423-02-BB	310	217
REN-8423-02-CC	310	144
REN-8423-02-GG	310	332
REN-8423-02-II	310	222
REN-8423-02-JJ	310	222
REN-8423-02-KK	310	188
REN-8423-02-KM	310	231
REN-8423-02-LL	310	217
REN-8423-02-NN	310	188
REN-8423-02-TT	310	231
REN-8423-02-VV	310	231
REN-8423-02-YY	310	188

CODE	PAGE	PRICE
REN-8800-00-BB	311	477
REN-8800-00-CC	311	318
REN-8800-00-GG	311	731
REN-8800-00-KK	311	413
REN-8800-00-KM	311	508
REN-8800-00-LL	311	477
REN-8800-00-NN	311	413
REN-8800-00-TT	311	508
REN-8800-00-VV	311	508
REN-8800-00-YY	311	413
ROS-4717-03-CC	129	27
ROS-4717-03-KK	129	35
ROS-9453-47-BB	172	98
ROS-9453-47-CC	172	65
ROS-9453-47-GG	172	143
ROS-9453-47-KK	172	85
ROS-9453-47-LL	172	98
ROS-9453-47-NN	172	85
ROS-9453-47-TT	172	104
ROS-9453-47-VV	172	104
ROS-9453-47-YY	172	85
ROU-1600-03-B	90	342
ROU-2000-99-B	91	562
ROU-8100-03-B	89	342
ROU-8100-04-B	71	342
ROU-8147-04-B	169	342
RVA-2020-01-B	338	174
RVA-2719-34-B	340	235
RVA-3404-00-B	322	682
RVA-3453-00-B	325	649
RVA-34B2-00-B	324	1725
RVA-9020-00-B	317	310
RVA-9020-P0-B	317	310
RVA-9181-00-B	318	474
RVA-9181-P0-B	318	474
RVA-9191-00-B	320	529
RVA-9191-P0-B	320	529
RVA-9521-00-B	326	685
RVA-9521-P0-B	326	685
RVA-9531-00-B	328	795
RVA-9531-P0-B	328	795
RVA-9562-00-B	330	299
RVA-9563-00-B	334	381
SUP-1015-14-BB	366	224
SUP-1015-14-CC	366	149
SUP-1015-14-GG	366	328
SUP-1015-14-KK	366	194
SUP-1015-14-LL	366	224
SUP-1015-14-NN	366	194
SUP-1015-14-TT	366	238
SUP-1015-14-VV	366	238
SUP-1015-14-YY	366	194
T04-1100-00-BB	72	3288
T04-1100-00-CC	72	2147
T04-1100-00-GG	72	4886
T04-1100-00-KK	72	2604
T04-1100-00-KM	72	3517
T04-1100-00-LL	72	3288

CODE	PAGE	PRICE
T04-1100-00-NN	72	2832
T04-1100-00-TT	72	3517
T04-1100-00-VV	72	3517
T04-1100-00-YY	72	2832
T04-8100-00L-BB	71	879
T04-8100-00L-CC	71	472
T04-8100-00L-GG	71	1449
T04-8100-00L-KK	71	635
T04-8100-00L-KM	71	960
T04-8100-00L-LL	71	879
T04-8100-00L-NN	71	635
T04-8100-00L-TT	71	960
T04-8100-00L-VV	71	960
T04-8100-00L-YY	71	716
T04-8120-00L-BB	71	1083
T04-8120-00L-CC	71	608
T04-8120-00L-GG	71	1748
T04-8120-00L-KK	71	893
T04-8120-00L-KM	71	1178
T04-8120-00L-LL	71	1083
T04-8120-00L-NN	71	893
T04-8120-00L-TT	71	1178
T04-8120-00L-VV	71	1178
T04-8120-00L-YY	71	893
T04-9139-00-BB	72	503
T04-9139-00-CC	72	335
T04-9139-00-GG	72	737
T04-9139-00-KK	72	436
T04-9139-00-LL	72	503
T04-9139-00-NN	72	436
T04-9139-00-TT	72	536
T04-9139-00-VV	72	536
T04-9139-00-YY	72	436
T04-9180-00-BB	73	551
T04-9180-00-CC	73	367
T04-9180-00-GG	73	807
T04-9180-00-KK	73	477
T04-9180-00-KM	73	587
T04-9180-00-LL	73	551
T04-9180-00-NN	73	477
T04-9180-00-TT	73	587
T04-9180-00-VV	73	587
T04-9180-00-YY	73	477
T04-9190-00-BB	73	551
T04-9190-00-CC	73	367
T04-9190-00-GG	73	807
T04-9190-00-KK	73	477
T04-9190-00-LL	73	551
T04-9190-00-NN	73	477
T04-9190-00-TT	73	587
T04-9190-00-VV	73	587
T04-9190-00-YY	73	477
T04-9404-00-BB	74	776
T04-9404-00-CC	74	517
T04-9404-00-GG	74	1137
T04-9404-00-KK	74	672
T04-9404-00-LL	74	776
T04-9404-00-NN	74	672

Actual products may differ from pictures. Actual products measures may differ from the measures shown. All USD prices are subject to change without notice. Effective as of August 2023.

PRICE INDEX

CODE	PAGE	PRICE
T04-9404-00-TT	74	827
T04-9404-00-VV	74	827
T04-9404-00-YY	74	672
T04-9453-00-BB	74	776
T04-9453-00-CC	74	517
T04-9453-00-GG	74	1137
T04-9453-00-KK	74	672
T04-9453-00-LL	74	776
T04-9453-00-NN	74	672
T04-9453-00-TT	74	827
T04-9453-00-VV	74	827
T04-9453-00-YY	74	672
T04-9521-00-BB	74	650
T04-9521-00-CC	74	433
T04-9521-00-GG	74	953
T04-9521-00-KK	74	563
T04-9521-00-KM	74	693
T04-9521-00-LL	74	650
T04-9521-00-NN	74	563
T04-9521-00-TT	74	693
T04-9521-00-VV	74	693
T04-9521-00-YY	74	563
T04-9531-00-BB	75	650
T04-9531-00-CC	75	433
T04-9531-00-GG	75	953
T04-9531-00-KK	75	563
T04-9531-00-KM	75	693
T04-9531-00-LL	75	650
T04-9531-00-NN	75	563
T04-9531-00-TT	75	693
T04-9531-00-VV	75	693
T04-9531-00-YY	75	563
T04-9560-02-BB	75	321
T04-9560-02-CC	75	214
T04-9560-02-GG	75	471
T04-9560-02-KK	75	278
T04-9560-02-LL	75	321
T04-9560-02-NN	75	278
T04-9560-02-TT	75	342
T04-9560-02-VV	75	342
T04-9560-02-YY	75	278
T04-9560-03-BB	76	321
T04-9560-03-CC	76	214
T04-9560-03-GG	76	471
T04-9560-03-KK	76	278
T04-9560-03-LL	76	321
T04-9560-03-NN	76	278
T04-9560-03-TT	76	342
T04-9560-03-VV	76	342
T04-9560-03-YY	76	278
T04-9649-00-BB	76	321
T04-9649-00-CC	76	214
T04-9649-00-GG	76	471
T04-9649-00-KK	76	278
T04-9649-00-LL	76	321
T04-9649-00-NN	76	278
T04-9649-00-TT	76	342
T04-9649-00-VV	76	342

CODE	PAGE	PRICE
T04-9649-00-YY	76	278
T05-1100-02-BB	89	3458
T05-1100-02-CC	89	2260
T05-1100-02-GG	89	5134
T05-1100-02-KK	89	2979
T05-1100-02-LL	89	3458
T05-1100-02-NN	89	2979
T05-1100-02-TT	89	3697
T05-1100-02-VV	89	3697
T05-1100-02-YY	89	2979
T05-1600-00-BB	90	1348
T05-1600-00-CC	90	785
T05-1600-00-GG	90	2137
T05-1600-00-KK	90	1123
T05-1600-00-LL	90	1348
T05-1600-00-NN	90	1123
T05-1600-00-TT	90	1461
T05-1600-00-VV	90	1461
T05-1600-00-YY	90	1123
T05-2001-00-BB	91	2614
T05-2001-00-CC	91	1556
T05-2001-00-GG	91	4097
T05-2001-00-KK	91	2191
T05-2001-00-LL	91	2614
T05-2001-00-NN	91	2191
T05-2001-00-TT	91	2826
T05-2001-00-VV	91	2826
T05-2001-00-YY	91	2191
T05-8100-00L-BB	89	1027
T05-8100-00L-CC	89	571
T05-8100-00L-GG	89	1666
T05-8100-00L-KK	89	845
T05-8100-00L-LL	89	1027
T05-8100-00L-NN	89	845
T05-8100-00L-TT	89	1118
T05-8100-00L-VV	89	1118
T05-8100-00L-YY	89	845
T05-9139-01-BB	91	525
T05-9139-01-CC	91	350
T05-9139-01-GG	91	770
T05-9139-01-KK	91	455
T05-9139-01-LL	91	525
T05-9139-01-NN	91	455
T05-9139-01-TT	91	560
T05-9139-01-VV	91	560
T05-9139-01-YY	91	455
T05-9181-00-BB	91	665
T05-9181-00-CC	91	443
T05-9181-00-GG	91	975
T05-9181-00-KK	91	576
T05-9181-00-LL	91	665
T05-9181-00-NN	91	576
T05-9181-00-TT	91	709
T05-9181-00-VV	91	709
T05-9181-00-YY	91	576
T05-9404-00-BB	92	841
T05-9404-00-CC	92	561
T05-9404-00-GG	92	1233

CODE	PAGE	PRICE
T05-9404-00-KK	92	729
T05-9404-00-LL	92	841
T05-9404-00-NN	92	729
T05-9404-00-TT	92	897
T05-9404-00-VV	92	897
T05-9404-00-YY	92	729
T05-9521-00-BB	92	702
T05-9521-00-CC	92	468
T05-9521-00-GG	92	1030
T05-9521-00-KK	92	608
T05-9521-00-LL	92	702
T05-9521-00-NN	92	608
T05-9521-00-TT	92	749
T05-9521-00-VV	92	749
T05-9521-00-YY	92	608
T05-9531-00-BB	93	702
T05-9531-00-CC	93	468
T05-9531-00-GG	93	1030
T05-9531-00-KK	93	608
T05-9531-00-LL	93	702
T05-9531-00-NN	93	608
T05-9531-00-TT	93	749
T05-9531-00-VV	93	749
T05-9531-00-YY	93	608
T05-9560-02-BB	93	366
T05-9560-02-CC	93	244
T05-9560-02-GG	93	537
T05-9560-02-KK	93	317
T05-9560-02-LL	93	366
T05-9560-02-NN	93	317
T05-9560-02-TT	93	390
T05-9560-02-VV	93	390
T05-9560-02-YY	93	317
T05-9560-03-BB	94	366
T05-9560-03-CC	94	244
T05-9560-03-GG	94	537
T05-9560-03-KK	94	317
T05-9560-03-LL	94	366
T05-9560-03-NN	94	317
T05-9560-03-TT	94	390
T05-9560-03-VV	94	390
T05-9560-03-YY	94	317
T05-9600-00-BB	94	366
T05-9600-00-CC	94	244
T05-9600-00-GG	94	537
T05-9600-00-KK	94	317
T05-9600-00-LL	94	366
T05-9600-00-NN	94	317
T05-9600-00-TT	94	390
T05-9600-00-VV	94	390
T05-9600-00-YY	94	317
T05-9649-00-BB	94	366
T05-9649-00-CC	94	244
T05-9649-00-GG	94	537
T05-9649-00-KK	94	317
T05-9649-00-LL	94	366
T05-9649-00-NN	94	317
T05-9649-00-TT	94	390

Finishes:

CC = chrome, CD = chrome diamond, CF = smokey chrome, KK = matte black, LL = satin brass, BB = white, NN = brushed nickel, YY = polished nickel, TT = venetian bronze, VV = satin copper, GG = gold, KM = black titanium, CB = chrome white, KB = matte black white, LB = satin brass white, NB = brushed nickel white, YB = polished nickel white, TB = venetian bronze, VB = satin copper white, GB = gold white

PRICE INDEX

CODE	PAGE	PRICE
T05-9649-00-VV	94	390
T05-9649-00-YY	94	317
T14-9180-00-BB	105	780
T14-9180-00-CC	105	520
T14-9180-00-GG	105	1144
T14-9180-00-KK	105	676
T14-9180-00-LL	105	780
T14-9180-00-NN	105	676
T14-9180-00-TT	105	832
T14-9180-00-VV	105	832
T14-9180-00-YY	105	676
T16-9404-00-BB	111	842
T16-9404-00-CC	111	561
T16-9404-00-GG	111	1234
T16-9404-00-KK	111	729
T16-9404-00-LL	111	842
T16-9404-00-NN	111	729
T16-9404-00-TT	111	898
T16-9404-00-VV	111	898
T16-9404-00-YY	111	729
T16-9560-02-BB	112	431
T16-9560-02-CC	112	287
T16-9560-02-GG	112	631
T16-9560-02-KK	112	373
T16-9560-02-LL	112	431
T16-9560-02-NN	112	373
T16-9560-02-TT	112	459
T16-9560-02-VV	112	459
T16-9560-02-YY	112	373
T16-9560-03-BB	112	431
T16-9560-03-CC	112	287
T16-9560-03-GG	112	631
T16-9560-03-KK	112	373
T16-9560-03-LL	112	431
T16-9560-03-NN	112	373
T16-9560-03-TT	112	459
T16-9560-03-VV	112	459
T16-9560-03-YY	112	373
T16-9601-00-BB	113	431
T16-9601-00-CC	113	287
T16-9601-00-GG	113	631
T16-9601-00-KK	113	373
T16-9601-00-LL	113	431
T16-9601-00-NN	113	373
T16-9601-00-TT	113	459
T16-9601-00-VV	113	459
T16-9601-00-YY	113	373
T16-9641-00-BB	113	431
T16-9641-00-CC	113	287
T16-9641-00-GG	113	631
T16-9641-00-KK	113	373
T16-9641-00-LL	113	431
T16-9641-00-NN	113	373
T16-9641-00-TT	113	459
T16-9641-00-VV	113	459
T16-9641-00-YY	113	373
T18-9404-00-BB	111	842
T18-9404-00-CB	111	561

CODE	PAGE	PRICE
T18-9404-00-CC	111	561
T18-9404-00-GB	111	1234
T18-9404-00-GG	111	1234
T18-9404-00-KB	111	729
T18-9404-00-KK	111	729
T18-9404-00-LB	111	842
T18-9404-00-LL	111	842
T18-9404-00-NB	111	729
T18-9404-00-NN	111	729
T18-9404-00-TB	111	898
T18-9404-00-TT	111	898
T18-9404-00-VB	111	898
T18-9404-00-VV	111	898
T18-9404-00-YY	111	729
T18-9404-00-YY	111	729
T18-9560-02-BB	112	431
T18-9560-02-CB	112	287
T18-9560-02-CC	112	287
T18-9560-02-GB	112	631
T18-9560-02-GG	112	631
T18-9560-02-KB	112	373
T18-9560-02-KK	112	373
T18-9560-02-LB	112	431
T18-9560-02-LL	112	431
T18-9560-02-NB	112	373
T18-9560-02-NN	112	373
T18-9560-02-TB	112	459
T18-9560-02-TT	112	459
T18-9560-02-VB	112	459
T18-9560-02-VV	112	459
T18-9560-02-YB	112	373
T18-9560-02-YY	112	373
T18-9560-03-BB	112	431
T18-9560-03-CB	112	287
T18-9560-03-CC	112	287
T18-9560-03-GB	112	631
T18-9560-03-GG	112	631
T18-9560-03-KB	112	373
T18-9560-03-KK	112	373
T18-9560-03-LB	112	431
T18-9560-03-LL	112	431
T18-9560-03-NB	112	373
T18-9560-03-NN	112	373
T18-9560-03-TB	112	459
T18-9560-03-TT	112	459
T18-9560-03-VB	112	459
T18-9560-03-VV	112	459
T18-9560-03-YB	112	373
T18-9560-03-YY	112	373
T18-9601-00-BB	113	431
T18-9601-00-CB	113	287
T18-9601-00-CC	113	287
T18-9601-00-GB	113	631
T18-9601-00-GG	113	631
T18-9601-00-KB	113	373
T18-9601-00-KK	113	373
T18-9601-00-LB	113	431
T18-9601-00-LL	113	431

CODE	PAGE	PRICE
T18-9601-00-NB	113	373
T18-9601-00-NN	113	373
T18-9601-00-TB	113	459
T18-9601-00-TT	113	459
T18-9601-00-VB	113	459
T18-9601-00-VV	113	459
T18-9601-00-YB	113	373
T18-9601-00-YY	113	373
T18-9641-00-BB	113	431
T18-9641-00-CB	113	287
T18-9641-00-CC	113	287
T18-9641-00-GB	113	631
T18-9641-00-GG	113	631
T18-9641-00-KB	113	373
T18-9641-00-KK	113	373
T18-9641-00-LB	113	431
T18-9641-00-LL	113	431
T18-9641-00-NB	113	373
T18-9641-00-NN	113	373
T18-9641-00-TB	113	459
T18-9641-00-TT	113	459
T18-9641-00-VB	113	459
T18-9641-00-VV	113	459
T18-9641-00-YB	113	373
T18-9641-00-YY	113	373
T26-9404-00-CD	119	999
T26-9560-02-CD	119	424
T26-9560-03-CD	120	424
T26-9600-00-CD	120	424
T26-9640-00-CD	121	424
T27-9404-00-BB	119	1032
T27-9404-00-CC	119	688
T27-9404-00-GG	119	1514
T27-9404-00-KK	119	894
T27-9404-00-LL	119	1032
T27-9404-00-NN	119	894
T27-9404-00-TT	119	1101
T27-9404-00-VV	119	1101
T27-9404-00-YY	119	894
T27-9560-02-BB	119	431
T27-9560-02-CC	119	287
T27-9560-02-GG	119	631
T27-9560-02-KK	119	373
T27-9560-02-LL	119	431
T27-9560-02-NN	119	373
T27-9560-02-TT	119	459
T27-9560-02-VV	119	459
T27-9560-02-YY	119	373
T27-9560-03-BB	120	431
T27-9560-03-CC	120	287
T27-9560-03-GG	120	631
T27-9560-03-KK	120	373
T27-9560-03-LL	120	431
T27-9560-03-NN	120	373
T27-9560-03-TT	120	459
T27-9560-03-VV	120	459
T27-9560-03-YY	120	373
T27-9600-00-BB	120	431

Actual products may differ from pictures. Actual products measures may differ from the measures shown. All USD prices are subject to change without notice. Effective as of August 2023.

PRICE INDEX

CODE	PAGE	PRICE
T27-9600-00-CC	120	287
T27-9600-00-GG	120	631
T27-9600-00-KK	120	373
T27-9600-00-LL	120	431
T27-9600-00-NN	120	373
T27-9600-00-TT	120	459
T27-9600-00-VV	120	459
T27-9600-00-YY	120	373
T27-9640-00-BB	121	431
T27-9640-00-CC	121	287
T27-9640-00-GG	121	631
T27-9640-00-KK	121	373
T27-9640-00-LL	121	431
T27-9640-00-NN	121	373
T27-9640-00-TT	121	459
T27-9640-00-VV	121	459
T27-9640-00-YY	121	373
T28-9404-00-BB	119	1032
T28-9404-00-CC	119	688
T28-9404-00-GG	119	1514
T28-9404-00-KK	119	894
T28-9404-00-LL	119	1032
T28-9404-00-NN	119	894
T28-9404-00-TT	119	1101
T28-9404-00-VV	119	1101
T28-9404-00-YY	119	894
T28-9560-02-BB	119	431
T28-9560-02-CC	119	287
T28-9560-02-GG	119	631
T28-9560-02-KK	119	373
T28-9560-02-LL	119	431
T28-9560-02-NN	119	373
T28-9560-02-TT	119	459
T28-9560-02-VV	119	459
T28-9560-02-YY	119	373
T28-9560-03-BB	120	431
T28-9560-03-CC	120	287
T28-9560-03-GG	120	631
T28-9560-03-KK	120	373
T28-9560-03-LL	120	431
T28-9560-03-NN	120	373
T28-9560-03-TT	120	459
T28-9560-03-VV	120	459
T28-9560-03-YY	120	373
T28-9600-00-BB	120	431
T28-9600-00-CC	120	287
T28-9600-00-GG	120	631
T28-9600-00-KK	120	373
T28-9600-00-LL	120	431
T28-9600-00-NN	120	373
T28-9600-00-TT	120	459
T28-9600-00-VV	120	459
T28-9600-00-YY	120	373
T28-9640-00-BB	121	431
T28-9640-00-CC	121	287
T28-9640-00-GG	121	631
T28-9640-00-KK	121	373
T28-9640-00-LL	121	431

CODE	PAGE	PRICE
T28-9640-00-NN	121	373
T28-9640-00-TT	121	459
T28-9640-00-VV	121	459
T28-9640-00-YY	121	373
T35-9320-00-III	131	2610
T35-9320-00-IIK	131	2610
T35-9320-00-IJI	131	2610
T35-9320-00-IJK	131	2610
T35-9320-00-IKI	131	2610
T35-9320-00-IKK	131	2610
T35-9320-00-KII	131	2610
T35-9320-00-KIK	131	2610
T35-9320-00-KJI	131	2610
T35-9320-00-KJK	131	2610
T35-9320-00-KKI	131	2610
T35-9320-00-KKK	131	2610
T35-9521-00-CI	131	1046
T35-9521-00-CJ	131	1046
T35-9521-00-CK	131	1046
T35-9521-00-II	131	1263
T35-9521-00-IJ	131	1263
T35-9521-00-IK	131	1263
T35-9521-00-KI	131	1263
T35-9521-00-KJ	131	1263
T35-9521-00-KK	131	1263
T45-1100-00-BB	137	3288
T45-1100-00-CC	137	2147
T45-1100-00-GG	137	4886
T45-1100-00-KK	137	2832
T45-1100-00-LL	137	3288
T45-1100-00-NN	137	2832
T45-1100-00-TT	137	3517
T45-1100-00-VV	137	3517
T45-1100-00-YY	137	2832
T45-1600-00-BB	138	1366
T45-1600-00-CC	138	796
T45-1600-00-GG	138	2163
T45-1600-00-KK	138	1138
T45-1600-00-LL	138	1366
T45-1600-00-NN	138	1138
T45-1600-00-TT	138	1480
T45-1600-00-VV	138	1480
T45-1600-00-YY	138	1138
T45-2002-00-BB	138	2614
T45-2002-00-CC	138	1556
T45-2002-00-GG	138	4097
T45-2002-00-KK	138	2191
T45-2002-00-LL	138	2614
T45-2002-00-NN	138	2191
T45-2002-00-TT	138	2826
T45-2002-00-VV	138	2826
T45-2002-00-YY	138	2191
T45-8100-04L-BB	137	826
T45-8100-04L-CC	137	437
T45-8100-04L-GG	137	1372
T45-8100-04L-KK	137	671
T45-8100-04L-LL	137	826
T45-8100-04L-NN	137	671

CODE	PAGE	PRIX
T45-8100-04L-TT	137	904
T45-8100-04L-VV	137	904
T45-8100-04L-YY	137	671
T45-9139-01-BB	138	488
T45-9139-01-CC	138	325
T45-9139-01-GG	138	715
T45-9139-01-KK	138	423
T45-9139-01-LL	138	488
T45-9139-01-NN	138	423
T45-9139-01-TT	138	520
T45-9139-01-VV	138	520
T45-9139-01-YY	138	423
T45-9180-01-BB	139	522
T45-9180-01-CC	139	348
T45-9180-01-GG	139	766
T45-9180-01-KK	139	452
T45-9180-01-LL	139	522
T45-9180-01-NN	139	452
T45-9180-01-TT	139	557
T45-9180-01-VV	139	557
T45-9180-01-YY	139	452
T45-9190-01-BB	139	522
T45-9190-01-CC	139	348
T45-9190-01-GG	139	766
T45-9190-01-KK	139	452
T45-9190-01-LL	139	522
T45-9190-01-NN	139	452
T45-9190-01-TT	139	557
T45-9190-01-VV	139	557
T45-9190-01-YY	139	452
T45-9404-00-BB	139	746
T45-9404-00-CC	139	497
T45-9404-00-GG	139	1093
T45-9404-00-KK	139	646
T45-9404-00-LL	139	746
T45-9404-00-NN	139	646
T45-9404-00-TT	139	795
T45-9404-00-VV	139	795
T45-9404-00-YY	139	646
T45-9453-00-BB	140	746
T45-9453-00-CC	140	497
T45-9453-00-GG	140	1093
T45-9453-00-KK	140	646
T45-9453-00-LL	140	746
T45-9453-00-NN	140	646
T45-9453-00-TT	140	795
T45-9453-00-VV	140	795
T45-9453-00-YY	140	646
T45-9521-00-BB	140	594
T45-9521-00-CC	140	396
T45-9521-00-GG	140	871
T45-9521-00-KK	140	515
T45-9521-00-LL	140	594
T45-9521-00-NN	140	515
T45-9521-00-TT	140	634
T45-9521-00-VV	140	634
T45-9521-00-YY	140	515
T45-9531-00-BB	141	594

Finishes:

CC = chrome, CD = chrome diamond, CF = smokey chrome, KK = matte black, LL = satin brass, BB = white, NN = brushed nickel, YY = polished nickel, TT = venetian bronze, VV = satin copper, GG = gold, KM = black titanium, CB = chrome white, KB = matte black white, LB = satin brass white, NB = brushed nickel white, YB = polished nickel white, TB = venetian bronze, VB = satin copper white, GB = gold white

PRICE INDEX

CODE	PAGE	PRICE
T45-9531-00-CC	141	396
T45-9531-00-GG	141	871
T45-9531-00-KK	141	515
T45-9531-00-LL	141	594
T45-9531-00-NN	141	515
T45-9531-00-TT	141	634
T45-9531-00-VV	141	634
T45-9531-00-YY	141	515
T45-9560-02-BB	141	299
T45-9560-02-CC	141	199
T45-9560-02-GG	141	438
T45-9560-02-KK	141	259
T45-9560-02-LL	141	299
T45-9560-02-NN	141	259
T45-9560-02-TT	141	318
T45-9560-02-VV	141	318
T45-9560-02-YY	141	259
T45-9560-03-BB	142	299
T45-9560-03-CC	142	199
T45-9560-03-GG	142	438
T45-9560-03-KK	142	259
T45-9560-03-LL	142	299
T45-9560-03-NN	142	259
T45-9560-03-TT	142	318
T45-9560-03-VV	142	318
T45-9560-03-YY	142	259
T45-9600-00-BB	142	299
T45-9600-00-CC	142	199
T45-9600-00-GG	142	438
T45-9600-00-KK	142	259
T45-9600-00-LL	142	299
T45-9600-00-NN	142	259
T45-9600-00-TT	142	318
T45-9600-00-VV	142	318
T45-9600-00-YY	142	259
T45-9649-00-BB	142	299
T45-9649-00-CC	142	199
T45-9649-00-GG	142	438
T45-9649-00-KK	142	259
T45-9649-00-LL	142	299
T45-9649-00-NN	142	259
T45-9649-00-TT	142	318
T45-9649-00-VV	142	318
T45-9649-00-YY	142	259
T46-1100-00-BB	154	3458
T46-1100-00-CC	154	2260
T46-1100-00-GG	154	5134
T46-1100-00-KK	154	2979
T46-1100-00-LL	154	3458
T46-1100-00-NN	154	2979
T46-1100-00-TT	154	3697
T46-1100-00-VV	154	3697
T46-1100-00-YY	154	2979
T46-2001-00-BB	154	2614
T46-2001-00-CC	154	1556
T46-2001-00-GG	154	4097
T46-2001-00-KK	154	2191
T46-2001-00-LL	154	2614

CODE	PAGE	PRICE
T46-2001-00-NN	154	2191
T46-2001-00-TT	154	2826
T46-2001-00-VV	154	2826
T46-2001-00-YY	154	2191
T46-8100-04L-BB	153	851
T46-8100-04L-CC	153	453
T46-8100-04L-GG	153	1407
T46-8100-04L-KK	153	692
T46-8100-04L-LL	153	851
T46-8100-04L-NN	153	692
T46-8100-04L-TT	153	930
T46-8100-04L-VV	153	930
T46-8100-04L-YY	153	692
T46-9139-00-BB	155	503
T46-9139-00-CC	155	335
T46-9139-00-GG	155	737
T46-9139-00-KK	155	436
T46-9139-00-LL	155	503
T46-9139-00-NN	155	436
T46-9139-00-TT	155	536
T46-9139-00-VV	155	536
T46-9139-00-YY	155	436
T46-9180-00-BB	155	551
T46-9180-00-CC	155	367
T46-9180-00-GG	155	807
T46-9180-00-KK	155	477
T46-9180-00-LL	155	551
T46-9180-00-NN	155	477
T46-9180-00-TT	155	587
T46-9180-00-VV	155	587
T46-9180-00-YY	155	477
T46-9404-00-BB	155	776
T46-9404-00-CC	155	517
T46-9404-00-GG	155	1137
T46-9404-00-KK	155	672
T46-9404-00-LL	155	776
T46-9404-00-NN	155	672
T46-9404-00-TT	155	827
T46-9404-00-VV	155	827
T46-9404-00-YY	155	672
T46-9453-00-BB	156	776
T46-9453-00-CC	156	517
T46-9453-00-GG	156	1137
T46-9453-00-KK	156	672
T46-9453-00-LL	156	776
T46-9453-00-NN	156	672
T46-9453-00-TT	156	827
T46-9453-00-VV	156	827
T46-9453-00-YY	156	672
T46-9521-00-BB	156	650
T46-9521-00-CC	156	433
T46-9521-00-GG	156	953
T46-9521-00-KK	156	563
T46-9521-00-LL	156	650
T46-9521-00-NN	156	563
T46-9521-00-TT	156	693
T46-9521-00-VV	156	693
T46-9521-00-YY	156	563

CODE	PAGE	PRICE
T46-9531-00-BB	157	650
T46-9531-00-CC	157	433
T46-9531-00-GG	157	953
T46-9531-00-KK	157	563
T46-9531-00-LL	157	650
T46-9531-00-NN	157	563
T46-9531-00-TT	157	693
T46-9531-00-VV	157	693
T46-9531-00-YY	157	563
T46-9560-02-BB	157	321
T46-9560-02-CC	157	214
T46-9560-02-GG	157	471
T46-9560-02-KK	157	278
T46-9560-02-LL	157	321
T46-9560-02-NN	157	278
T46-9560-02-TT	157	342
T46-9560-02-VV	157	342
T46-9560-02-YY	157	278
T46-9560-03-BB	158	321
T46-9560-03-CC	158	214
T46-9560-03-GG	158	471
T46-9560-03-KK	158	278
T46-9560-03-LL	158	321
T46-9560-03-NN	158	278
T46-9560-03-TT	158	342
T46-9560-03-VV	158	342
T46-9560-03-YY	158	278
T46-9649-00-BB	158	321
T46-9649-00-CC	158	214
T46-9649-00-GG	158	471
T46-9649-00-KK	158	278
T46-9649-00-LL	158	321
T46-9649-00-NN	158	278
T46-9649-00-TT	158	342
T46-9649-00-VV	158	342
T46-9649-00-YY	158	278
T47-1100-00-Bx	169	5325
T47-1100-00-Cx	169	3505
T47-1100-00-Gx	169	7873
T47-1100-00-Kx	169	4597
T47-1100-00-Lx	169	5325
T47-1100-00-Nx	169	4597
T47-1100-00-Tx	169	5689
T47-1100-00-Vx	169	5689
T47-1100-00-Yx	169	4597
T47-8100-00L-Bx	169	1155
T47-8100-00L-Cx	169	656
T47-8100-00L-Gx	169	1854
T47-8100-00L-Kx	169	955
T47-8100-00L-Lx	169	1155
T47-8100-00L-Nx	169	955
T47-8100-00L-Tx	169	1255
T47-8100-00L-Vx	169	1255
T47-8100-00L-Yx	169	955
T47-9453-00-Bx	170	899
T47-9453-00-Cx	170	599
T47-9453-00-Gx	170	1498
T47-9453-00-Kx	170	779

Actual products may differ from pictures. Actual products measures may differ from the measures shown. All USD prices are subject to change without notice. Effective as of August 2023.

PRICE INDEX

CODE	PAGE	PRICE
T47-9453-00-Lx	170	899
T47-9453-00-Nx	170	779
T47-9453-00-Tx	170	958
T47-9453-00-Vx	170	958
T47-9453-00-Yx	170	779
T47-9560-02-Bx	170	476
T47-9560-02-Cx	170	317
T47-9560-02-Gx	170	697
T47-9560-02-Kx	170	412
T47-9560-02-Lx	170	476
T47-9560-02-Nx	170	412
T47-9560-02-Tx	170	507
T47-9560-02-Vx	170	507
T47-9560-02-Yx	170	412
T47-9560-03-Bx	171	476
T47-9560-03-Cx	171	317
T47-9560-03-Gx	171	697
T47-9560-03-Kx	171	412
T47-9560-03-Lx	171	476
T47-9560-03-Nx	171	412
T47-9560-03-Tx	171	507
T47-9560-03-Vx	171	507
T47-9560-03-Yx	171	412
T47-9600-00-Bx	171	476
T47-9600-00-Cx	171	317
T47-9600-00-Gx	171	697
T47-9600-00-Kx	171	412
T47-9600-00-Lx	171	476
T47-9600-00-Nx	171	412
T47-9600-00-Tx	171	507
T47-9600-00-Vx	171	507
T47-9600-00-Yx	171	412
T47-9649-00-Bx	171	476
T47-9649-00-Cx	171	317
T47-9649-00-Gx	171	697
T47-9649-00-Kx	171	412
T47-9649-00-Lx	171	476
T47-9649-00-Nx	171	412
T47-9649-00-Tx	171	507
T47-9649-00-Vx	171	507
T47-9649-00-Yx	171	412
T51-9521-00-BB	181	928
T51-9521-00-CC	181	618
T51-9521-00-CF	181	618
T51-9521-00-KK	181	804
T51-9531-00-BB	181	928
T51-9531-00-CC	181	618
T51-9531-00-CF	181	618
T51-9531-00-KK	181	804
T56-1100-00-CB	186	3361
T56-1100-00-CC	186	3361
T56-1100-00-CF	186	3361
T56-9404-00-CB	187	641
T56-9404-00-CC	187	641
T56-9404-00-CF	187	641
T56-9521-00-CB	187	618
T56-9521-00-CC	187	618
T56-9521-00-CF	187	618

CODE	PAGE	PRICE
T56-9531-00-CB	188	618
T56-9531-00-CC	188	618
T56-9531-00-CF	188	618
T56-9560-02-CB	188	297
T56-9560-02-CC	188	297
T56-9560-02-CF	188	297
T56-9560-03-CB	189	297
T56-9560-03-CC	189	297
T56-9560-03-CF	189	297
T56-9649-00-CB	189	297
T56-9649-00-CC	189	297
T56-9649-00-CF	189	297
T66-1100-02-BB	199	2913
T66-1100-02-CC	199	1897
T66-1100-02-GG	199	4335
T66-1100-02-KK	199	2507
T66-1100-02-LL	199	2913
T66-1100-02-NN	199	2507
T66-1100-02-TT	199	3116
T66-1100-02-VV	199	3116
T66-1100-02-YY	199	2507
T66-1600-00-BB	200	1096
T66-1600-00-CC	200	617
T66-1600-00-GG	200	1767
T66-1600-00-KK	200	904
T66-1600-00-LL	200	1096
T66-1600-00-NN	200	904
T66-1600-00-TT	200	1192
T66-1600-00-VV	200	1192
T66-1600-00-YY	200	904
T66-2001-00-BB	200	2396
T66-2001-00-CC	200	1410
T66-2001-00-GG	200	3776
T66-2001-00-KK	200	2002
T66-2001-00-LL	200	2396
T66-2001-00-NN	200	2002
T66-2001-00-TT	200	2593
T66-2001-00-VV	200	2593
T66-2001-00-YY	200	2002
T66-2001-PB-BB	200	2396
T66-2001-PB-CC	200	1410
T66-2001-PB-GG	200	3776
T66-2001-PB-KK	200	2002
T66-2001-PB-LL	200	2396
T66-2001-PB-NN	200	2002
T66-2001-PB-TT	200	2593
T66-2001-PB-VV	200	2593
T66-2001-PB-YY	200	2002
T66-8100-03L-BB	197	741
T66-8100-03L-CC	197	380
T66-8100-03L-GG	197	1246
T66-8100-03L-KK	197	597
T66-8100-03L-LL	197	741
T66-8100-03L-NN	197	597
T66-8100-03L-TT	197	813
T66-8100-03L-VV	197	813
T66-8100-03L-YY	197	597
T66-8100-04L-BB	198	741

CODE	PAGE	PRICE
T66-8100-04L-CC	198	380
T66-8100-04L-GG	198	1246
T66-8100-04L-KK	198	597
T66-8100-04L-LL	198	741
T66-8100-04L-NN	198	597
T66-8100-04L-TT	198	813
T66-8100-04L-VV	198	813
T66-8100-04L-YY	198	597
T66-8120-04L-BB	198	863
T66-8120-04L-CC	198	462
T66-8120-04L-GG	198	1426
T66-8120-04L-KK	198	703
T66-8120-04L-LL	198	863
T66-8120-04L-NN	198	703
T66-8120-04L-TT	198	944
T66-8120-04L-VV	198	944
T66-8120-04L-YY	198	703
T66-9139-00-BB	201	344
T66-9139-00-CC	201	229
T66-9139-00-GG	201	504
T66-9139-00-KK	201	298
T66-9139-00-LL	201	344
T66-9139-00-NN	201	298
T66-9139-00-TT	201	366
T66-9139-00-VV	201	366
T66-9139-00-YY	201	298
T66-9181-00-BB	201	449
T66-9181-00-CC	201	299
T66-9181-00-GG	201	658
T66-9181-00-KK	201	389
T66-9181-00-LL	201	449
T66-9181-00-NN	201	389
T66-9181-00-TT	201	478
T66-9181-00-VV	201	478
T66-9181-00-YY	201	389
T66-9190-00-BB	202	449
T66-9190-00-CC	202	299
T66-9190-00-GG	202	658
T66-9190-00-KK	202	389
T66-9190-00-LL	202	449
T66-9190-00-NN	202	389
T66-9190-00-TT	202	478
T66-9190-00-VV	202	478
T66-9190-00-YY	202	389
T66-9404-00-BB	202	668
T66-9404-00-CC	202	445
T66-9404-00-GG	202	979
T66-9404-00-KK	202	579
T66-9404-00-LL	202	668
T66-9404-00-NN	202	579
T66-9404-00-TT	202	712
T66-9404-00-VV	202	712
T66-9404-00-YY	202	579
T66-9453-00-BB	202	668
T66-9453-00-CC	202	445
T66-9453-00-GG	202	979
T66-9453-00-KK	202	579
T66-9453-00-LL	202	668

Finishes:

CC = chrome, CD = chrome diamond, CF = smokey chrome, KK = matte black, LL = satin brass, BB = white, NN = brushed nickel, YY = polished nickel, TT = venetian bronze, VV = satin copper, GG = gold, KM = black titanium, CB = chrome white, KB = matte black white, LB = satin brass white, NB = brushed nickel white, YB = polished nickel white, TB = venetian bronze, VB = satin copper white, GB = gold white

PRICE INDEX

CODE	PAGE	PRICE
T66-9453-00-NN	202	579
T66-9453-00-TT	202	712
T66-9453-00-VV	202	712
T66-9453-00-YY	202	579
T66-9521-00-BB	203	576
T66-9521-00-CC	203	384
T66-9521-00-GG	203	845
T66-9521-00-KK	203	499
T66-9521-00-LL	203	576
T66-9521-00-NN	203	499
T66-9521-00-TT	203	614
T66-9521-00-VV	203	614
T66-9521-00-YY	203	499
T66-9531-00-BB	203	576
T66-9531-00-CC	203	384
T66-9531-00-GG	203	845
T66-9531-00-KK	203	499
T66-9531-00-LL	203	576
T66-9531-00-NN	203	499
T66-9531-00-TT	203	614
T66-9531-00-VV	203	614
T66-9531-00-YY	203	499
T66-9560-02-BB	204	282
T66-9560-02-CC	204	188
T66-9560-02-GG	204	414
T66-9560-02-KK	204	244
T66-9560-02-LL	204	282
T66-9560-02-NN	204	244
T66-9560-02-TT	204	301
T66-9560-02-VV	204	301
T66-9560-02-YY	204	244
T66-9560-03-BB	204	282
T66-9560-03-CC	204	188
T66-9560-03-GG	204	414
T66-9560-03-KK	204	244
T66-9560-03-LL	204	282
T66-9560-03-NN	204	244
T66-9560-03-TT	204	301
T66-9560-03-VV	204	301
T66-9560-03-YY	204	244
T66-9600-00-BB	204	282
T66-9600-00-CC	204	188
T66-9600-00-GG	204	414
T66-9600-00-KK	204	244
T66-9600-00-LL	204	282
T66-9600-00-NN	204	244
T66-9600-00-TT	204	301
T66-9600-00-VV	204	301
T66-9600-00-YY	204	244
T66-9649-00-BB	205	282
T66-9649-00-CC	205	188
T66-9649-00-GG	205	414
T66-9649-00-KK	205	244
T66-9649-00-LL	205	282
T66-9649-00-NN	205	244
T66-9649-00-TT	205	301
T66-9649-00-VV	205	301
T66-9649-00-YY	205	244

CODE	PAGE	PRICE
T71-9404-00-BB	217	842
T71-9404-00-CC	217	561
T71-9404-00-GG	217	1234
T71-9404-00-KK	217	729
T71-9404-00-LL	217	842
T71-9404-00-NN	217	729
T71-9404-00-TT	217	898
T71-9404-00-VV	217	898
T71-9404-00-YY	217	729
T71-9560-02-BB	218	431
T71-9560-02-CC	218	287
T71-9560-02-GG	218	631
T71-9560-02-KK	218	373
T71-9560-02-LL	218	431
T71-9560-02-NN	218	373
T71-9560-02-TT	218	459
T71-9560-02-VV	218	459
T71-9560-02-YY	218	373
T71-9560-03-BB	218	431
T71-9560-03-CC	218	287
T71-9560-03-GG	218	631
T71-9560-03-KK	218	373
T71-9560-03-LL	218	431
T71-9560-03-NN	218	373
T71-9560-03-TT	218	459
T71-9560-03-VV	218	459
T71-9560-03-YY	218	373
T71-9601-00-BB	219	431
T71-9601-00-CC	219	287
T71-9601-00-GG	219	631
T71-9601-00-KK	219	373
T71-9601-00-LL	219	431
T71-9601-00-NN	219	373
T71-9601-00-TT	219	459
T71-9601-00-VV	219	459
T71-9601-00-YY	219	373
T71-9641-00-BB	219	431
T71-9641-00-CC	219	287
T71-9641-00-GG	219	631
T71-9641-00-KK	219	373
T71-9641-00-LL	219	431
T71-9641-00-NN	219	373
T71-9641-00-TT	219	459
T71-9641-00-VV	219	459
T71-9641-00-YY	219	373
T72-9404-00-BB	217	842
T72-9404-00-CC	217	561
T72-9404-00-GG	217	1234
T72-9404-00-KK	217	729
T72-9404-00-LL	217	842
T72-9404-00-NN	217	729
T72-9404-00-TT	217	898
T72-9404-00-VV	217	898
T72-9404-00-YY	217	729
T72-9560-02-BB	218	431
T72-9560-02-CC	218	287
T72-9560-02-GG	218	631
T72-9560-02-KK	218	373
T72-9560-02-LL	218	431
T72-9560-02-NN	218	373
T72-9560-02-TT	218	459
T72-9560-02-VV	218	459
T72-9560-02-YY	218	373

CODE	PAGE	PRICE
T72-9560-02-LL	218	431
T72-9560-02-NN	218	373
T72-9560-02-TT	218	459
T72-9560-02-VV	218	459
T72-9560-02-YY	218	373
T72-9560-03-BB	218	431
T72-9560-03-CC	218	287
T72-9560-03-GG	218	631
T72-9560-03-KK	218	373
T72-9560-03-LL	218	431
T72-9560-03-NN	218	373
T72-9560-03-TT	218	459
T72-9560-03-VV	218	459
T72-9560-03-YY	218	373
T72-9601-00-BB	219	431
T72-9601-00-CC	219	287
T72-9601-00-GG	219	631
T72-9601-00-KK	219	373
T72-9601-00-LL	219	431
T72-9601-00-NN	219	373
T72-9601-00-TT	219	459
T72-9601-00-VV	219	459
T72-9601-00-YY	219	373
T72-9641-00-BB	219	431
T72-9641-00-CC	219	287
T72-9641-00-GG	219	631
T72-9641-00-KK	219	373
T72-9641-00-LL	219	431
T72-9641-00-NN	219	373
T72-9641-00-TT	219	459
T72-9641-00-VV	219	459
T72-9641-00-YY	219	373
T74-9404-00-BB	224	842
T74-9404-00-CB	224	561
T74-9404-00-GB	224	1234
T74-9404-00-KB	224	729
T74-9404-00-LB	224	842
T74-9404-00-NB	224	729
T74-9404-00-TB	224	898
T74-9404-00-VB	224	898
T74-9404-00-YB	224	729
T74-9560-02-BB	225	431
T74-9560-02-CB	225	287
T74-9560-02-GB	225	631
T74-9560-02-KB	225	373
T74-9560-02-LB	225	431
T74-9560-02-NB	225	373
T74-9560-02-TB	225	459
T74-9560-02-VB	225	459
T74-9560-02-YB	225	373
T74-9560-03-BB	225	431
T74-9560-03-CB	225	287
T74-9560-03-GB	225	631
T74-9560-03-KB	225	373
T74-9560-03-LB	225	431
T74-9560-03-NB	225	373
T74-9560-03-TB	225	459
T74-9560-03-VB	225	459

Actual products may differ from pictures. Actual products measures may differ from the measures shown. All USD prices are subject to change without notice. Effective as of August 2023.

PRICE INDEX

CODE	PAGE	PRICE
T74-9560-03-YB	225	373
T74-9601-00-BB	225	431
T74-9601-00-CB	225	287
T74-9601-00-GB	225	631
T74-9601-00-KB	225	373
T74-9601-00-LB	225	431
T74-9601-00-NB	225	373
T74-9601-00-TB	225	459
T74-9601-00-VB	225	459
T74-9601-00-YB	225	373
T74-9641-00-BB	226	431
T74-9641-00-CB	226	287
T74-9641-00-GB	226	631
T74-9641-00-KB	226	373
T74-9641-00-LB	226	431
T74-9641-00-NB	226	373
T74-9641-00-TB	226	459
T74-9641-00-VB	226	459
T74-9641-00-YB	226	373
T80-1101-00-BB	240	3101
T80-1101-00-CC	240	2022
T80-1101-00-GG	240	4610
T80-1101-00-KK	240	2669
T80-1101-00-LL	240	3101
T80-1101-00-NN	240	2669
T80-1101-00-TT	240	3316
T80-1101-00-VV	240	3316
T80-1101-00-YY	240	2669
T80-1102-00-BB	241	3101
T80-1102-00-CC	241	2022
T80-1102-00-GG	241	4610
T80-1102-00-KK	241	2669
T80-1102-00-LL	241	3101
T80-1102-00-NN	241	2669
T80-1102-00-TT	241	3316
T80-1102-00-VV	241	3316
T80-1102-00-YY	241	2669
T80-9101-00-BB	243	318
T80-9101-00-CC	243	212
T80-9101-00-GG	243	466
T80-9101-00-KK	243	276
T80-9101-00-LL	243	318
T80-9101-00-NN	243	276
T80-9101-00-TT	243	339
T80-9101-00-VV	243	339
T80-9101-00-YY	243	276
T80-9102-00-BB	244	318
T80-9102-00-CC	244	212
T80-9102-00-GG	244	466
T80-9102-00-KK	244	276
T80-9102-00-LL	244	318
T80-9102-00-NN	244	276
T80-9102-00-TT	244	339
T80-9102-00-VV	244	339
T80-9102-00-YY	244	276
T80-9181-00-BB	245	413
T80-9181-00-CC	245	275
T80-9181-00-GG	245	605

CODE	PAGE	PRICE
T80-9181-00-KK	245	358
T80-9181-00-LL	245	413
T80-9181-00-NN	245	358
T80-9181-00-TT	245	440
T80-9181-00-VV	245	440
T80-9181-00-YY	245	358
T80-9182-00-BB	246	413
T80-9182-00-CC	246	275
T80-9182-00-GG	246	605
T80-9182-00-KK	246	358
T80-9182-00-LL	246	413
T80-9182-00-NN	246	358
T80-9182-00-TT	246	440
T80-9182-00-VV	246	440
T80-9182-00-YY	246	358
T80-9191-00-BB	247	413
T80-9191-00-CC	247	275
T80-9191-00-GG	247	605
T80-9191-00-KK	247	358
T80-9191-00-LL	247	413
T80-9191-00-NN	247	358
T80-9191-00-TT	247	440
T80-9191-00-VV	247	440
T80-9191-00-YY	247	358
T80-9192-00-BB	248	413
T80-9192-00-CC	248	275
T80-9192-00-GG	248	605
T80-9192-00-KK	248	358
T80-9192-00-LL	248	413
T80-9192-00-NN	248	358
T80-9192-00-TT	248	440
T80-9192-00-VV	248	440
T80-9192-00-YY	248	358
T80-9401-00-BB	249	638
T80-9401-00-CC	249	425
T80-9401-00-GG	249	935
T80-9401-00-KK	249	553
T80-9401-00-LL	249	638
T80-9401-00-NN	249	553
T80-9401-00-TT	249	680
T80-9401-00-VV	249	680
T80-9401-00-YY	249	553
T80-9402-00-BB	250	638
T80-9402-00-CC	250	425
T80-9402-00-GG	250	935
T80-9402-00-KK	250	553
T80-9402-00-LL	250	638
T80-9402-00-NN	250	553
T80-9402-00-TT	250	680
T80-9402-00-VV	250	680
T80-9402-00-YY	250	553
T80-9453-00-BB	251	638
T80-9453-00-CC	251	425
T80-9453-00-GG	251	935
T80-9453-00-KK	251	553
T80-9453-00-LL	251	638
T80-9453-00-NN	251	553
T80-9453-00-TT	251	680

CODE	PAGE	PRICE
T80-9453-00-VV	251	680
T80-9453-00-YY	251	553
T80-9521-00-BB	252	548
T80-9521-00-CC	252	365
T80-9521-00-GG	252	803
T80-9521-00-KK	252	475
T80-9521-00-LL	252	548
T80-9521-00-NN	252	475
T80-9521-00-TT	252	584
T80-9521-00-VV	252	584
T80-9521-00-YY	252	475
T80-9522-00-BB	254	548
T80-9522-00-CC	254	365
T80-9522-00-GG	254	803
T80-9522-00-KK	254	475
T80-9522-00-LL	254	548
T80-9522-00-NN	254	475
T80-9522-00-TT	254	584
T80-9522-00-VV	254	584
T80-9522-00-YY	254	475
T80-9531-00-BB	256	548
T80-9531-00-CC	256	365
T80-9531-00-GG	256	803
T80-9531-00-KK	256	475
T80-9531-00-LL	256	548
T80-9531-00-NN	256	475
T80-9531-00-TT	256	584
T80-9531-00-VV	256	584
T80-9531-00-YY	256	475
T80-9532-00-BB	258	548
T80-9532-00-CC	258	365
T80-9532-00-GG	258	803
T80-9532-00-KK	258	475
T80-9532-00-LL	258	548
T80-9532-00-NN	258	475
T80-9532-00-TT	258	584
T80-9532-00-VV	258	584
T80-9532-00-YY	258	475
T80-9560-02-BB	260	150
T80-9560-02-CC	260	100
T80-9560-02-GG	260	220
T80-9560-02-KK	260	130
T80-9560-02-LL	260	150
T80-9560-02-NN	260	130
T80-9560-02-TT	260	160
T80-9560-02-VV	260	160
T80-9560-02-YY	260	130
T80-9560-03-BB	261	150
T80-9560-03-CC	261	100
T80-9560-03-GG	261	220
T80-9560-03-KK	261	130
T80-9560-03-LL	261	150
T80-9560-03-NN	261	130
T80-9560-03-TT	261	160
T80-9560-03-VV	261	160
T80-9560-03-YY	261	130
T80-9649-00-BB	262	150
T80-9649-00-CC	262	100

Finishes:

CC = chrome, CD = chrome diamond, CF = smokey chrome, KK = matte black, LL = satin brass, BB = white, NN = brushed nickel, YY = polished nickel, TT = venetian bronze, VV = satin copper, GG = gold, KM = black titanium, CB = chrome white, KB = matte black white, LB = satin brass white, NB = brushed nickel white, YB = polished nickel white, TB = venetian bronze, VB = satin copper white, GB = gold white

PRICE INDEX

CODE	PAGE	PRICE
T80-9649-00-GG	262	220
T80-9649-00-KK	262	130
T80-9649-00-LL	262	150
T80-9649-00-NN	262	130
T80-9649-00-TT	262	160
T80-9649-00-VV	262	160
T80-9649-00-YY	262	130
TET-0304-05-BB	367	194
TET-0304-05-CC	367	129
TET-0304-05-GG	367	284
TET-0304-05-KK	367	168
TET-0304-05-LL	367	194
TET-0304-05-NN	367	168
TET-0304-05-TT	367	206
TET-0304-05-VV	367	206
TET-0304-05-YY	367	168
TET-0810-01-BB	367	668
TET-0810-01-CC	367	445
TET-0810-01-GG	367	979
TET-0810-01-KK	367	579
TET-0810-01-LL	367	668
TET-0810-01-NN	367	579
TET-0810-01-TT	367	712
TET-0810-01-VV	367	712
TET-0810-01-YY	367	579
TET-0811-02-BB	367	690
TET-0811-02-CC	367	460
TET-0811-02-GG	367	1012
TET-0811-02-KK	367	598
TET-0811-02-LL	367	690
TET-0811-02-NN	367	598
TET-0811-02-TT	367	736
TET-0811-02-VV	367	736
TET-0811-02-YY	367	598
TET-0812-03-BB	367	743
TET-0812-03-CC	367	495
TET-0812-03-GG	367	1089
TET-0812-03-KK	367	644
TET-0812-03-LL	367	743
TET-0812-03-NN	367	644
TET-0812-03-TT	367	792
TET-0812-03-VV	367	792
TET-0812-03-YY	367	644
TET-0813-01-CC	367	310
TET-0814-01-CC	368	330
TET-0815-01-BB	368	690
TET-0815-01-CC	368	460
TET-0815-01-GG	368	1012
TET-0815-01-KK	368	598
TET-0815-01-KM	368	736
TET-0815-01-LL	368	690
TET-0815-01-NN	368	598
TET-0815-01-TT	368	736
TET-0815-01-VV	368	736
TET-0815-01-YY	368	598
TET-1010-01-BB	368	863
TET-1010-01-CC	368	575
TET-1010-01-GG	368	1265

CODE	PAGE	PRICE
TET-1010-01-KK	368	748
TET-1010-01-LL	368	863
TET-1010-01-NN	368	748
TET-1010-01-TT	368	920
TET-1010-01-VV	368	920
TET-1010-01-YY	368	748
TET-1010-47-Bx	368	1499
TET-1010-47-Cx	368	999
TET-1010-47-Gx	368	2298
TET-1010-47-Kx	368	1299
TET-1010-47-Lx	368	1499
TET-1010-47-Nx	368	1299
TET-1010-47-Tx	368	1598
TET-1010-47-Vx	368	1598
TET-1010-47-Yx	368	1299
TET-1011-01-BB	368	945
TET-1011-01-CC	368	630
TET-1011-01-GG	368	1387
TET-1011-01-KK	368	819
TET-1011-01-LL	368	945
TET-1011-01-NN	368	819
TET-1011-01-TT	368	1008
TET-1011-01-VV	368	1008
TET-1011-01-YY	368	819
TET-1013-01-CC	369	416
TET-1013-01-KK	369	541
TET-1014-01-CC	369	439
TET-1208-01-CC	369	462
TET-1208-01-KK	369	601
TET-1210-01-BB	369	1125
TET-1210-01-CC	369	750
TET-1210-01-GG	369	1650
TET-1210-01-KK	369	975
TET-1210-01-LL	369	1125
TET-1210-01-NN	369	975
TET-1210-01-TT	369	1200
TET-1210-01-VV	369	1200
TET-1210-01-YY	369	975
TET-1210-35-III	133	1745
TET-1210-35-IIK	133	1745
TET-1210-35-IKI	133	1745
TET-1210-35-IKK	133	1745
TET-1210-35-JII	133	1745
TET-1210-35-JIK	133	1745
TET-1210-35-JKI	133	1745
TET-1210-35-JKK	133	1745
TET-1210-35-KII	133	1745
TET-1210-35-KIK	133	1745
TET-1210-35-KKI	133	1745
TET-1210-35-KKK	133	1745
TET-1212-04-BB	369	1238
TET-1212-04-CC	369	825
TET-1212-04-GG	369	1815
TET-1212-04-KK	369	1073
TET-1212-04-LL	369	1238
TET-1212-04-NN	369	1073
TET-1212-04-TT	369	1320
TET-1212-04-VV	369	1320

CODE	PAGE	PRICE
TET-1212-04-YY	369	1073
TET-1213-01-CC	370	572
TET-1214-01-CC	370	595
TET-1214-91-CC	370	763
TET-1613-01-CC	370	809
TET-1614-01-CC	370	832
TET-1614-91-CC	371	1006
TET-1616-01-BB	371	1793
TET-1616-01-CC	371	1195
TET-1616-01-GG	371	2629
TET-1616-01-KK	371	1554
TET-1616-01-LL	371	1793
TET-1616-01-NN	371	1554
TET-1616-01-TT	371	1912
TET-1616-01-VV	371	1912
TET-1616-01-YY	371	1554
TET-1616-02-BB	371	1943
TET-1616-02-CC	371	1295
TET-1616-02-GG	371	2849
TET-1616-02-KK	371	1684
TET-1616-02-LL	371	1943
TET-1616-02-NN	371	1684
TET-1616-02-TT	371	2072
TET-1616-02-VV	371	2072
TET-1616-02-YY	371	1684
TET-2012-01-CC	371	965
TET-3018-01-BB	371	2093
TET-3018-01-CC	371	1395
TET-3018-01-CF	371	1395
TET-3018-01-GG	371	3069
TET-3018-01-KK	371	1814
TET-3018-01-LL	371	2093
TET-3018-01-NN	371	1814
TET-3018-01-TT	371	2232
TET-3018-01-VV	371	2232
TET-3018-01-YY	371	1814
TRO-2100-04-BB	79	1487
TRO-2100-04-CC	79	888
TRO-2100-04-GG	79	2326
TRO-2100-04-KK	79	1247
TRO-2100-04-LL	79	1487
TRO-2100-04-NN	79	1247
TRO-2100-04-TT	79	1607
TRO-2100-04-VV	79	1607
TRO-2100-04-YY	79	1247
TRO-2101-80-BB	266	1295
TRO-2101-80-CC	266	760
TRO-2101-80-GG	266	2044
TRO-2101-80-KK	266	1081
TRO-2101-80-LL	266	1295
TRO-2101-80-NN	266	1081
TRO-2101-80-TT	266	1402
TRO-2101-80-VV	266	1402
TRO-2101-80-YY	266	1081
TRO-2102-80-BB	267	1295
TRO-2102-80-CC	267	760
TRO-2102-80-GG	267	2044
TRO-2102-80-KK	267	1081

Actual products may differ from pictures. Actual products measures may differ from the measures shown. All USD prices are subject to change without notice. Effective as of August 2023.

PRICE INDEX

CODE	PAGE	PRICE
TRO-2102-80-LL	267	1295
TRO-2102-80-NN	267	1081
TRO-2102-80-TT	267	1402
TRO-2102-80-VV	267	1402
TRO-2102-80-YY	267	1081
TRO-2105-45-BB	145	1453
TRO-2105-45-CC	145	865
TRO-2105-45-GG	145	2275
TRO-2105-45-KK	145	1218
TRO-2105-45-LL	145	1453
TRO-2105-45-NN	145	1218
TRO-2105-45-TT	145	1570
TRO-2105-45-VV	145	1570
TRO-2105-45-YY	145	1218
TRO-2115-66-BB	207	1100
TRO-2115-66-CC	207	630
TRO-2115-66-GG	207	1758
TRO-2115-66-KK	207	912
TRO-2115-66-LL	207	1100
TRO-2115-66-NN	207	912
TRO-2115-66-TT	207	1194
TRO-2115-66-VV	207	1194
TRO-2115-66-YY	207	912
TRO-2175-95-BB	97	1564
TRO-2175-95-CC	97	939
TRO-2175-95-GG	97	2438
TRO-2175-95-KK	97	1314
TRO-2175-95-LL	97	1564
TRO-2175-95-NN	97	1314
TRO-2175-95-TT	97	1688
TRO-2175-95-VV	97	1688
TRO-2175-95-YY	97	1314
TRO-2200-04-BB	79	1753
TRO-2200-04-CC	79	1065
TRO-2200-04-GG	79	2715
TRO-2200-04-KK	79	1478
TRO-2200-04-LL	79	1753
TRO-2200-04-NN	79	1478
TRO-2200-04-TT	79	1890
TRO-2200-04-VV	79	1890
TRO-2200-04-YY	79	1478
TRO-2201-80-BB	268	1586
TRO-2201-80-CC	268	954
TRO-2201-80-GG	268	2471
TRO-2201-80-KK	268	1333
TRO-2201-80-LL	268	1586
TRO-2201-80-NN	268	1333
TRO-2201-80-TT	268	1712
TRO-2201-80-VV	268	1712
TRO-2201-80-YY	268	1333
TRO-2202-80-BB	269	1601
TRO-2202-80-CC	269	964
TRO-2202-80-GG	269	2493
TRO-2202-80-KK	269	1346
TRO-2202-80-LL	269	1601
TRO-2202-80-NN	269	1346
TRO-2202-80-TT	269	1728
TRO-2202-80-VV	269	1728

CODE	PAGE	PRICE
TRO-2202-80-YY	269	1346
TRO-2210-66-BB	207	814
TRO-2210-66-CC	207	439
TRO-2210-66-GG	207	1338
TRO-2210-66-KK	207	664
TRO-2210-66-LL	207	814
TRO-2210-66-NN	207	664
TRO-2210-66-TT	207	888
TRO-2210-66-VV	207	888
TRO-2210-66-YY	207	664
TRO-2220-66-BB	208	1322
TRO-2220-66-CC	208	778
TRO-2220-66-GG	208	2084
TRO-2220-66-KK	208	1104
TRO-2220-66-LL	208	1322
TRO-2220-66-NN	208	1104
TRO-2220-66-TT	208	1431
TRO-2220-66-VV	208	1431
TRO-2220-66-YY	208	1104
TRO-2800-14-BB	107	2264
TRO-2800-14-CC	107	1351
TRO-2800-14-GG	107	3541
TRO-2800-14-KK	107	1899
TRO-2800-14-LL	107	2264
TRO-2800-14-NN	107	1899
TRO-2800-14-TT	107	2446
TRO-2800-14-VV	107	2446
TRO-2800-14-YY	107	1899
TRO-2801-80-BB	270	2114
TRO-2801-80-CC	270	1251
TRO-2801-80-GG	270	3321
TRO-2801-80-KK	270	1769
TRO-2801-80-LL	270	2114
TRO-2801-80-NN	270	1769
TRO-2801-80-TT	270	2286
TRO-2801-80-VV	270	2286
TRO-2801-80-YY	270	1769
TRO-2802-80-BB	271	2129
TRO-2802-80-CC	271	1261
TRO-2802-80-GG	271	3343
TRO-2802-80-KK	271	1782
TRO-2802-80-LL	271	2129
TRO-2802-80-NN	271	1782
TRO-2802-80-TT	271	2302
TRO-2802-80-VV	271	2302
TRO-2802-80-YY	271	1782
TRO-2805-04-BB	80	2223
TRO-2805-04-CC	80	1324
TRO-2805-04-GG	80	3482
TRO-2805-04-KK	80	1863
TRO-2805-04-LL	80	2223
TRO-2805-04-NN	80	1863
TRO-2805-04-TT	80	2403
TRO-2805-04-VV	80	2403
TRO-2805-04-YY	80	1863
TRO-2805-45-BB	145	2223
TRO-2805-45-CC	145	1324
TRO-2805-45-GG	145	3482

CODE	PAGE	PRICE
TRO-2805-45-KK	145	1863
TRO-2805-45-LL	145	2223
TRO-2805-45-NN	145	1863
TRO-2805-45-TT	145	2403
TRO-2805-45-VV	145	2403
TRO-2805-45-YY	145	1863
TRO-2805-66-BB	208	1923
TRO-2805-66-CC	208	1124
TRO-2805-66-GG	208	3042
TRO-2805-66-KK	208	1603
TRO-2805-66-LL	208	1923
TRO-2805-66-NN	208	1603
TRO-2805-66-TT	208	2083
TRO-2805-66-VV	208	2083
TRO-2805-66-YY	208	1603
TRO-2805-95-BB	97	2510
TRO-2805-95-CC	97	1515
TRO-2805-95-GG	97	3902
TRO-2805-95-KK	97	2112
TRO-2805-95-LL	97	2510
TRO-2805-95-NN	97	2112
TRO-2805-95-TT	97	2708
TRO-2805-95-VV	97	2708
TRO-2805-95-YY	97	2112
TRO-2811-80-CC	272	1321
TRO-2811-80-KK	272	1860
TRO-2812-80-CC	273	1351
TRO-2812-80-KK	273	1899
TRO-2815-04-CC	80	1409
TRO-2815-04-KK	80	1974
TRO-2815-45-CC	146	1071
TRO-2815-45-KK	146	1535
TRO-2815-46-CC	161	1121
TRO-2815-46-KK	161	1600
TRO-2815-66-CC	208	1021
TRO-2815-95-CC	98	1221
TRO-2816-66-CC	209	871
TRO-2816-66-KK	209	1275
TRO-2826-66-CC	209	1021
TRO-2826-66-KK	209	1470
TRO-2891-80-BB	274	1769
TRO-2891-80-CC	274	1021
TRO-2891-80-GG	274	2815
TRO-2891-80-KK	274	1470
TRO-2891-80-LL	274	1769
TRO-2891-80-NN	274	1470
TRO-2891-80-TT	274	1918
TRO-2891-80-VV	274	1918
TRO-2891-80-YY	274	1470
TRO-2892-80-BB	275	1806
TRO-2892-80-CC	275	1046
TRO-2892-80-GG	275	2870
TRO-2892-80-KK	275	1502
TRO-2892-80-LL	275	1806
TRO-2892-80-NN	275	1502
TRO-2892-80-TT	275	1958
TRO-2892-80-VV	275	1958
TRO-2892-80-YY	275	1502

Finishes:

CC = chrome, CD = chrome diamond, CF = smokey chrome, KK = matte black, LL = satin brass, BB = white, NN = brushed nickel, YY = polished nickel, TT = venetian bronze, VV = satin copper, GG = gold, KM = black titanium, CB = chrome white, KB = matte black white, LB = satin brass white, NB = brushed nickel white, YB = polished nickel white, TB = venetian bronze, VB = satin copper white, GB = gold white

PRICE INDEX

CODE	PAGE	PRICE
TRO-2896-04-BB	80	1919
TRO-2896-04-CC	80	1121
TRO-2896-04-GG	80	3035
TRO-2896-04-KK	80	1600
TRO-2896-04-LL	80	1919
TRO-2896-04-NN	80	1600
TRO-2896-04-TT	80	2078
TRO-2896-04-VV	80	2078
TRO-2896-04-YY	80	1600
TRO-2896-05-BB	98	2015
TRO-2896-05-CC	98	1185
TRO-2896-05-GG	98	3176
TRO-2896-05-KK	98	1683
TRO-2896-05-LL	98	2015
TRO-2896-05-NN	98	1683
TRO-2896-05-TT	98	2180
TRO-2896-05-VV	98	2180
TRO-2896-05-YY	98	1683
TRO-2896-45-BB	146	1889
TRO-2896-45-CC	146	1101
TRO-2896-45-GG	146	2991
TRO-2896-45-KK	146	1574
TRO-2896-45-LL	146	1889
TRO-2896-45-NN	146	1574
TRO-2896-45-TT	146	2046
TRO-2896-45-VV	146	2046
TRO-2896-45-YY	146	1574
TRO-2896-46-BB	161	1919
TRO-2896-46-CC	161	1121
TRO-2896-46-GG	161	3035
TRO-2896-46-KK	161	1600
TRO-2896-46-LL	161	1919
TRO-2896-46-NN	161	1600
TRO-2896-46-TT	161	2078
TRO-2896-46-VV	161	2078
TRO-2896-46-YY	161	1600
TRO-2896-66-BB	209	1814
TRO-2896-66-CC	209	1051
TRO-2896-66-GG	209	2881
TRO-2896-66-KK	209	1509
TRO-2896-66-LL	209	1814
TRO-2896-66-NN	209	1509
TRO-2896-66-TT	209	1966
TRO-2896-66-VV	209	1966
TRO-2896-66-YY	209	1509
TRO-2901-80-CC	276	1446
TRO-2902-80-CC	277	1466
TRO-2915-04-CC	81	1528
TRO-2915-04-KK	81	2145
TRO-2915-45-CC	146	1190
TRO-2915-45-KK	146	1706
TRO-2915-66-CC	210	1146
TRO-3301-80-BB	278	2448
TRO-3301-80-CC	278	1316
TRO-3301-80-GG	278	4033
TRO-3301-80-KK	278	1995
TRO-3301-80-LL	278	2448
TRO-3301-80-NN	278	1995

CODE	PAGE	PRICE
TRO-3301-80-TT	278	2674
TRO-3301-80-VV	278	2674
TRO-3301-80-YY	278	1995
TRO-3302-04-BB	81	2577
TRO-3302-04-CC	81	1402
TRO-3302-04-GG	81	4222
TRO-3302-04-KK	81	2107
TRO-3302-04-LL	81	2577
TRO-3302-04-NN	81	2107
TRO-3302-04-TT	81	2812
TRO-3302-04-VV	81	2812
TRO-3302-04-YY	81	2107
TRO-3302-45-BB	147	2705
TRO-3302-45-CC	147	1487
TRO-3302-45-GG	147	4409
TRO-3302-45-KK	147	2218
TRO-3302-45-LL	147	2705
TRO-3302-45-NN	147	2218
TRO-3302-45-TT	147	2948
TRO-3302-45-VV	147	2948
TRO-3302-45-YY	147	2218
TRO-3302-46-BB	162	2495
TRO-3302-46-CC	162	1347
TRO-3302-46-GG	162	4101
TRO-3302-46-KK	162	2036
TRO-3302-46-LL	162	2495
TRO-3302-46-NN	162	2036
TRO-3302-46-TT	162	2724
TRO-3302-46-VV	162	2724
TRO-3302-46-YY	162	2036
TRO-3302-47-Bx	175	3845
TRO-3302-47-Cx	175	2247
TRO-3302-47-Gx	175	6081
TRO-3302-47-Kx	175	3206
TRO-3302-47-Lx	175	3845
TRO-3302-47-Nx	175	3206
TRO-3302-47-Tx	175	4164
TRO-3302-47-Vx	175	4164
TRO-3302-47-Yx	175	3206
TRO-3302-66-BB	210	2604
TRO-3302-66-CC	210	1420
TRO-3302-66-GG	210	4262
TRO-3302-66-KK	210	2130
TRO-3302-66-LL	210	2604
TRO-3302-66-NN	210	2130
TRO-3302-66-TT	210	2841
TRO-3302-66-VV	210	2841
TRO-3302-66-YY	210	2130
TRO-3302-80-BB	280	2495
TRO-3302-80-CC	280	1347
TRO-3302-80-GG	280	4101
TRO-3302-80-KK	280	2036
TRO-3302-80-LL	280	2495
TRO-3302-80-NN	280	2036
TRO-3302-80-TT	280	2724
TRO-3302-80-VV	280	2724
TRO-3302-80-YY	280	2036
TRO-3303-47-Bx	175	4145

CODE	PAGE	PRICE
TRO-3303-47-Cx	175	2420
TRO-3303-47-Gx	175	6560
TRO-3303-47-Kx	175	3455
TRO-3303-47-Lx	175	4145
TRO-3303-47-Nx	175	3455
TRO-3303-47-Tx	175	4490
TRO-3303-47-Vx	175	4490
TRO-3303-47-Yx	175	3455
TRO-3304-47-Bx	176	2495
TRO-3304-47-Cx	176	1347
TRO-3304-47-Gx	176	4101
TRO-3304-47-Kx	176	2036
TRO-3304-47-Lx	176	2495
TRO-3304-47-Nx	176	2036
TRO-3304-47-Tx	176	2724
TRO-3304-47-Vx	176	2724
TRO-3304-47-Yx	176	2036
TRO-3311-80-BB	282	1797
TRO-3311-80-CC	282	882
TRO-3311-80-GG	282	3078
TRO-3311-80-KK	282	1431
TRO-3311-80-LL	282	1797
TRO-3311-80-NN	282	1431
TRO-3311-80-TT	282	1980
TRO-3311-80-VV	282	1980
TRO-3311-80-YY	282	1431
TRO-3352-47-Bx	176	3830
TRO-3352-47-Cx	176	2237
TRO-3352-47-Gx	176	6059
TRO-3352-47-Kx	176	3193
TRO-3352-47-Lx	176	3830
TRO-3352-47-Nx	176	3193
TRO-3352-47-Tx	176	4148
TRO-3352-47-Vx	176	4148
TRO-3352-47-Yx	176	3193
TRO-3405-04-BB	81	2678
TRO-3405-04-CC	81	1458
TRO-3405-04-GG	81	4385
TRO-3405-04-KK	81	2190
TRO-3405-04-LL	81	2678
TRO-3405-04-NN	81	2190
TRO-3405-04-TT	81	2921
TRO-3405-04-VV	81	2921
TRO-3405-04-YY	81	2190
TRO-3405-05-BB	98	3137
TRO-3405-05-CC	98	1764
TRO-3405-05-GG	98	5058
TRO-3405-05-KK	98	2588
TRO-3405-05-LL	98	3137
TRO-3405-05-NN	98	2588
TRO-3405-05-TT	98	3411
TRO-3405-05-VV	98	3411
TRO-3405-05-YY	98	2588
TRO-3405-45-BB	147	2762
TRO-3405-45-CC	147	1514
TRO-3405-45-GG	147	4508
TRO-3405-45-KK	147	2263
TRO-3405-45-LL	147	2762

Actual products may differ from pictures. Actual products measures may differ from the measures shown. All USD prices are subject to change without notice. Effective as of August 2023.

PRICE INDEX

CODE	PAGE	PRICE
TRO-3405-45-NN	147	2263
TRO-3405-45-TT	147	3011
TRO-3405-45-VV	147	3011
TRO-3405-45-YY	147	2263
TRO-3405-66-BB	210	2462
TRO-3405-66-CC	210	1314
TRO-3405-66-GG	210	4068
TRO-3405-66-KK	210	2003
TRO-3405-66-LL	210	2462
TRO-3405-66-NN	210	2003
TRO-3405-66-TT	210	2691
TRO-3405-66-VV	210	2691
TRO-3405-66-YY	210	2003
TRO-3420-16-BB	115	2537
TRO-3420-16-CC	115	1364
TRO-3420-16-GG	115	4178
TRO-3420-16-KK	115	2068
TRO-3420-16-LL	115	2537
TRO-3420-16-NN	115	2068
TRO-3420-16-TT	115	2771
TRO-3420-16-VV	115	2771
TRO-3420-16-YY	115	2068
TRO-3420-18-BB	116	2537
TRO-3420-18-CB	116	1364
TRO-3420-18-CC	116	1364
TRO-3420-18-GB	116	4178
TRO-3420-18-GG	116	4178
TRO-3420-18-KB	116	2068
TRO-3420-18-KK	116	2068
TRO-3420-18-LB	116	2537
TRO-3420-18-LL	116	2537
TRO-3420-18-NB	116	2068
TRO-3420-18-NN	116	2068
TRO-3420-18-TB	116	2771
TRO-3420-18-TT	116	2771
TRO-3420-18-VB	116	2771
TRO-3420-18-VV	116	2771
TRO-3420-18-YB	116	2068
TRO-3420-18-YY	116	2068
TRO-3420-26-CD	123	2814
TRO-3420-27-BB	124	3399
TRO-3420-27-CC	124	1939
TRO-3420-27-GG	124	5443
TRO-3420-27-KK	124	2815
TRO-3420-27-LL	124	3399
TRO-3420-27-NN	124	2815
TRO-3420-27-TT	124	3691
TRO-3420-27-VV	124	3691
TRO-3420-27-YY	124	2815
TRO-3420-28-BB	124	3399
TRO-3420-28-CC	124	1939
TRO-3420-28-GG	124	5443
TRO-3420-28-KK	124	2815
TRO-3420-28-LL	124	3399
TRO-3420-28-NN	124	2815
TRO-3420-28-TT	124	3691
TRO-3420-28-VV	124	3691
TRO-3420-28-YY	124	2815

CODE	PAGE	PRICE
TRO-3420-71-BB	221	3144
TRO-3420-71-CC	221	1769
TRO-3420-71-GG	221	5069
TRO-3420-71-KK	221	2594
TRO-3420-71-LL	221	3144
TRO-3420-71-NN	221	2594
TRO-3420-71-TT	221	3419
TRO-3420-71-VV	221	3419
TRO-3420-71-YY	221	2594
TRO-3420-72-BB	222	3144
TRO-3420-72-CC	222	1769
TRO-3420-72-GG	222	5069
TRO-3420-72-KK	222	2594
TRO-3420-72-LL	222	3144
TRO-3420-72-NN	222	2594
TRO-3420-72-TT	222	3419
TRO-3420-72-VV	222	3419
TRO-3420-72-YY	222	2594
TRO-3420-74-BB	229	3144
TRO-3420-74-CB	229	1769
TRO-3420-74-GB	229	5069
TRO-3420-74-KB	229	2594
TRO-3420-74-LB	229	3144
TRO-3420-74-NB	229	2594
TRO-3420-74-TB	229	3419
TRO-3420-74-VB	229	3419
TRO-3420-74-YB	229	2594
TRO-3950-04-BB	82	4306
TRO-3950-04-CC	82	2408
TRO-3950-04-GG	82	6962
TRO-3950-04-KK	82	3547
TRO-3950-04-LL	82	4306
TRO-3950-04-NN	82	3547
TRO-3950-04-TT	82	4685
TRO-3950-04-VV	82	4685
TRO-3950-04-YY	82	3547
TRO-3950-46-BB	162	5041
TRO-3950-46-CC	162	2898
TRO-3950-46-GG	162	8040
TRO-3950-46-KK	162	4184
TRO-3950-46-LL	162	5041
TRO-3950-46-NN	162	4184
TRO-3950-46-TT	162	5469
TRO-3950-46-VV	162	5469
TRO-3950-46-YY	162	4184
TRO-3950-56-CB	191	3688
TRO-3950-56-CC	191	3688
TRO-3950-56-CF	191	3688
TRO-4201-66-BB	211	2150
TRO-4201-66-CC	211	1205
TRO-4201-66-GG	211	3473
TRO-4201-66-KK	211	1772
TRO-4201-66-LL	211	2150
TRO-4201-66-NN	211	1772
TRO-4201-66-TT	211	2339
TRO-4201-66-VV	211	2339
TRO-4201-66-YY	211	1772
TRO-4201-80-BB	284	2383

CODE	PAGE	PRICE
TRO-4201-80-CC	284	1360
TRO-4201-80-GG	284	3814
TRO-4201-80-KK	284	1974
TRO-4201-80-LL	284	2383
TRO-4201-80-NN	284	1974
TRO-4201-80-TT	284	2587
TRO-4201-80-VV	284	2587
TRO-4201-80-YY	284	1974
TRO-4202-80-BB	285	2480
TRO-4202-80-CC	285	1425
TRO-4202-80-GG	285	3957
TRO-4202-80-KK	285	2058
TRO-4202-80-LL	285	2480
TRO-4202-80-NN	285	2058
TRO-4202-80-TT	285	2691
TRO-4202-80-VV	285	2691
TRO-4202-80-YY	285	2058
TRO-4205-04-BB	82	2330
TRO-4205-04-CC	82	1325
TRO-4205-04-GG	82	3737
TRO-4205-04-KK	82	1928
TRO-4205-04-KM	82	2531
TRO-4205-04-LL	82	2330
TRO-4205-04-NN	82	1928
TRO-4205-04-TT	82	2531
TRO-4205-04-VV	82	2531
TRO-4205-04-YY	82	1928
TRO-4206-05-BB	99	2480
TRO-4206-05-CC	99	1425
TRO-4206-05-GG	99	3957
TRO-4206-05-KK	99	2058
TRO-4206-05-LL	99	2480
TRO-4206-05-NN	99	2058
TRO-4206-05-TT	99	2691
TRO-4206-05-VV	99	2691
TRO-4206-05-YY	99	2058
TRO-4206-45-BB	147	2233
TRO-4206-45-CC	147	1260
TRO-4206-45-GG	147	3594
TRO-4206-45-KK	147	1844
TRO-4206-45-LL	147	2233
TRO-4206-45-NN	147	1844
TRO-4206-45-TT	147	2427
TRO-4206-45-VV	147	2427
TRO-4206-45-YY	147	1844
TRO-4206-46-BB	162	2518
TRO-4206-46-CC	162	1450
TRO-4206-46-GG	162	4012
TRO-4206-46-KK	162	2091
TRO-4206-46-LL	162	2518
TRO-4206-46-NN	162	2091
TRO-4206-46-TT	162	2731
TRO-4206-46-VV	162	2731
TRO-4206-46-YY	162	2091
TRO-4206-66-BB	211	2000
TRO-4206-66-CC	211	1105
TRO-4206-66-GG	211	3253
TRO-4206-66-KK	211	1642

Finishes:

CC = chrome, CD = chrome diamond, CF = smokey chrome, KK = matte black, LL = satin brass, BB = white, NN = brushed nickel, YY = polished nickel, TT = venetian bronze, VV = satin copper, GG = gold, KM = black titanium, CB = chrome white, KB = matte black white, LB = satin brass white, NB = brushed nickel white, YB = polished nickel white, TB = venetian bronze, VB = satin copper white, GB = gold white

PRICE INDEX

CODE	PAGE	PRICE
TRO-4206-66-LL	211	2000
TRO-4206-66-NN	211	1642
TRO-4206-66-TT	211	2179
TRO-4206-66-VV	211	2179
TRO-4206-66-YY	211	1642
TRO-4211-80-CC	286	1390
TRO-4211-80-KK	286	2013
TRO-4212-80-CC	287	1440
TRO-4212-80-KK	287	2078
TRO-4215-04-CC	82	1440
TRO-4215-04-KK	82	2078
TRO-4216-05-CC	99	1540
TRO-4216-05-KK	99	2208
TRO-4216-45-CC	148	1110
TRO-4216-45-KK	148	1649
TRO-4216-46-CC	163	1347
TRO-4216-51-BB	183	2983
TRO-4216-51-CC	183	1760
TRO-4216-51-CF	183	1760
TRO-4216-51-KK	183	2494
TRO-4216-66-CC	211	915
TRO-4216-66-KK	211	1395
TRO-4225-05-CC	99	1684
TRO-4226-46-BB	163	2713
TRO-4226-46-CC	163	1580
TRO-4226-46-GG	163	4298
TRO-4226-46-KK	163	2260
TRO-4226-46-LL	163	2713
TRO-4226-46-NN	163	2260
TRO-4226-46-TT	163	2939
TRO-4226-46-VV	163	2939
TRO-4226-46-YY	163	2260
TRO-4226-56-CB	191	2083
TRO-4226-56-CC	191	2083
TRO-4226-56-CF	191	2083
TRO-4236-46-BB	163	2975
TRO-4236-46-CC	163	1755
TRO-4236-46-GG	163	4683
TRO-4236-46-KK	163	2487
TRO-4236-46-LL	163	2975
TRO-4236-46-NN	163	2487
TRO-4236-46-TT	163	3219
TRO-4236-46-VV	163	3219
TRO-4236-46-YY	163	2487
TRO-4236-56-CB	192	2447
TRO-4236-56-CC	192	2447
TRO-4236-56-CF	192	2447
TRO-4246-56-CB	192	2290
TRO-4246-56-CC	192	2290
TRO-4246-56-CF	192	2290
TRO-4255-56-CB	192	2390
TRO-4255-56-CC	192	2390
TRO-4255-56-CF	192	2390
TRO-4291-51-BB	183	2878
TRO-4291-51-CC	183	1690
TRO-4291-51-CF	183	1690
TRO-4291-51-KK	183	2403
TRO-4291-80-BB	288	2006

CODE	PAGE	PRICE
TRO-4291-80-CC	288	1109
TRO-4291-80-GG	288	3262
TRO-4291-80-KK	288	1647
TRO-4291-80-LL	288	2006
TRO-4291-80-NN	288	1647
TRO-4291-80-TT	288	2185
TRO-4291-80-VV	288	2185
TRO-4291-80-YY	288	1647
TRO-4292-80-BB	289	2105
TRO-4292-80-CC	289	1175
TRO-4292-80-GG	289	3407
TRO-4292-80-KK	289	1733
TRO-4292-80-LL	289	2105
TRO-4292-80-NN	289	1733
TRO-4292-80-TT	289	2291
TRO-4292-80-VV	289	2291
TRO-4292-80-YY	289	1733
TRO-4296-04-BB	83	1951
TRO-4296-04-CC	83	1072
TRO-4296-04-GG	83	3180
TRO-4296-04-KK	83	1599
TRO-4296-04-LL	83	1951
TRO-4296-04-NN	83	1599
TRO-4296-04-TT	83	2126
TRO-4296-04-VV	83	2126
TRO-4296-04-YY	83	1599
TRO-4296-05-BB	100	2246
TRO-4296-05-CC	100	1269
TRO-4296-05-GG	100	3614
TRO-4296-05-KK	100	1855
TRO-4296-05-LL	100	2246
TRO-4296-05-NN	100	1855
TRO-4296-05-TT	100	2441
TRO-4296-05-VV	100	2441
TRO-4296-05-YY	100	1855
TRO-4296-46-BB	164	2149
TRO-4296-46-CC	164	1204
TRO-4296-46-GG	164	3471
TRO-4296-46-KK	164	1771
TRO-4296-46-LL	164	2149
TRO-4296-46-NN	164	1771
TRO-4296-46-TT	164	2337
TRO-4296-46-VV	164	2337
TRO-4296-46-YY	164	1771
TRO-4296-56-CB	193	1510
TRO-4296-56-CC	193	1510
TRO-4296-56-CF	193	1510
TRO-4297-45-BB	148	1858
TRO-4297-45-CC	148	1010
TRO-4297-45-GG	148	3044
TRO-4297-45-KK	148	1519
TRO-4297-45-LL	148	1858
TRO-4297-45-NN	148	1519
TRO-4297-45-TT	148	2027
TRO-4297-45-CC	148	2027
TRO-4297-45-YY	148	1519
TRO-4297-66-BB	212	1768
TRO-4297-66-CC	212	950

CODE	PAGE	PRICE
TRO-4297-66-GG	212	2912
TRO-4297-66-KK	212	1441
TRO-4297-66-LL	212	1768
TRO-4297-66-NN	212	1441
TRO-4297-66-TT	212	1931
TRO-4297-66-VV	212	1931
TRO-4297-66-YY	212	1441
TRO-4301-80-BB	290	2678
TRO-4301-80-CC	290	1520
TRO-4301-80-GG	290	4298
TRO-4301-80-KK	290	2215
TRO-4301-80-LL	290	2678
TRO-4301-80-NN	290	2215
TRO-4301-80-TT	290	2909
TRO-4301-80-VV	290	2909
TRO-4301-80-YY	290	2215
TRO-4302-66-BB	212	2444
TRO-4302-66-CC	212	1364
TRO-4302-66-GG	212	3955
TRO-4302-66-KK	212	2012
TRO-4302-66-LL	212	2444
TRO-4302-66-NN	212	2012
TRO-4302-66-TT	212	2659
TRO-4302-66-VV	212	2659
TRO-4302-66-YY	212	2012
TRO-4302-80-BB	291	2775
TRO-4302-80-CC	291	1585
TRO-4302-80-GG	291	4441
TRO-4302-80-KK	291	2299
TRO-4302-80-LL	291	2775
TRO-4302-80-NN	291	2299
TRO-4302-80-TT	291	3013
TRO-4302-80-VV	291	3013
TRO-4302-80-YY	291	2299
TRO-4305-04-BB	83	2946
TRO-4305-04-CC	83	1699
TRO-4305-04-GG	83	4692
TRO-4305-04-KK	83	2447
TRO-4305-04-KM	83	3195
TRO-4305-04-LL	83	2946
TRO-4305-04-NN	83	2447
TRO-4305-04-TT	83	3195
TRO-4305-04-VV	83	3195
TRO-4305-04-YY	83	2447
TRO-4306-05-BB	100	2985
TRO-4306-05-CC	100	1725
TRO-4306-05-GG	100	4749
TRO-4306-05-KK	100	2481
TRO-4306-05-LL	100	2985
TRO-4306-05-NN	100	2481
TRO-4306-05-TT	100	3237
TRO-4306-05-VV	100	3237
TRO-4306-05-YY	100	2481
TRO-4306-45-BB	148	2835
TRO-4306-45-CC	148	1625
TRO-4306-45-GG	148	4529
TRO-4306-45-KK	148	2351
TRO-4306-45-LL	148	2835

Actual products may differ from pictures. Actual products measures may differ from the measures shown. All USD prices are subject to change without notice. Effective as of August 2023.

PRICE INDEX

CODE	PAGE	PRICE
TRO-4306-45-NN	148	2351
TRO-4306-45-TT	148	3077
TRO-4306-45-VV	148	3077
TRO-4306-45-YY	148	2351
TRO-4306-46-BB	164	3134
TRO-4306-46-CC	164	1824
TRO-4306-46-GG	164	4967
TRO-4306-46-KK	164	2610
TRO-4306-46-LL	164	3134
TRO-4306-46-NN	164	2610
TRO-4306-46-TT	164	3395
TRO-4306-46-VV	164	3395
TRO-4306-46-YY	164	2610
TRO-4306-66-BB	212	2295
TRO-4306-66-CC	212	1265
TRO-4306-66-GG	212	3737
TRO-4306-66-KK	212	1883
TRO-4306-66-LL	212	2295
TRO-4306-66-NN	212	1883
TRO-4306-66-TT	212	2501
TRO-4306-66-VV	212	2501
TRO-4306-66-YY	212	1883
TRO-4316-04-CC	84	1850
TRO-4316-04-KK	84	2644
TRO-4316-66-CC	213	1100
TRO-4316-66-KK	213	1669
TRO-4326-56-CB	193	2493
TRO-4326-56-CC	193	2493
TRO-4326-56-CF	193	2493
TRO-4394-66-BB	213	3057
TRO-4394-66-CC	213	1773
TRO-4394-66-GG	213	4855
TRO-4394-66-KK	213	2543
TRO-4394-66-LL	213	3057
TRO-4394-66-NN	213	2543
TRO-4394-66-TT	213	3314
TRO-4394-66-VV	213	3314
TRO-4394-66-YY	213	2543
TRO-4395-05-BB	100	3818
TRO-4395-05-CC	100	2280
TRO-4395-05-GG	100	5970
TRO-4395-05-KK	100	3203
TRO-4395-05-LL	100	3818
TRO-4395-05-NN	100	3203
TRO-4395-05-TT	100	4125
TRO-4395-05-VV	100	4125
TRO-4395-05-YY	100	3203
TRR-2800-14-BB	107	2264
TRR-2800-14-CC	107	1351
TRR-2800-14-GG	107	3541
TRR-2800-14-KK	107	1899
TRR-2800-14-LL	107	2264
TRR-2800-14-NN	107	1899
TRR-2800-14-TT	107	2446
TRR-2800-14-VV	107	2446
TRR-2800-14-YY	107	1899
TRR-2801-80-BB	270	2114
TRR-2801-80-CC	270	1251

CODE	PAGE	PRICE
TRR-2801-80-GG	270	3321
TRR-2801-80-KK	270	1769
TRR-2801-80-LL	270	2114
TRR-2801-80-NN	270	1769
TRR-2801-80-TT	270	2286
TRR-2801-80-VV	270	2286
TRR-2801-80-YY	270	1769
TRR-2802-80-BB	271	2129
TRR-2802-80-CC	271	1261
TRR-2802-80-GG	271	3343
TRR-2802-80-KK	271	1782
TRR-2802-80-LL	271	2129
TRR-2802-80-NN	271	1782
TRR-2802-80-TT	271	2302
TRR-2802-80-VV	271	2302
TRR-2802-80-YY	271	1782
TRR-2805-04-BB	80	2223
TRR-2805-04-CC	80	1324
TRR-2805-04-GG	80	3482
TRR-2805-04-KK	80	1863
TRR-2805-04-LL	80	2223
TRR-2805-04-NN	80	1863
TRR-2805-04-TT	80	2403
TRR-2805-04-VV	80	2403
TRR-2805-04-YY	80	1863
TRR-2805-45-BB	145	2223
TRR-2805-45-CC	145	1324
TRR-2805-45-GG	145	3482
TRR-2805-45-KK	145	1863
TRR-2805-45-LL	145	2223
TRR-2805-45-NN	145	1863
TRR-2805-45-TT	145	2403
TRR-2805-45-VV	145	2403
TRR-2805-45-YY	145	1863
TRR-2805-66-BB	208	1923
TRR-2805-66-CC	208	1124
TRR-2805-66-GG	208	3042
TRR-2805-66-KK	208	1603
TRR-2805-66-LL	208	1923
TRR-2805-66-NN	208	1603
TRR-2805-66-TT	208	2083
TRR-2805-66-VV	208	2083
TRR-2805-66-YY	208	1603
TRR-2805-95-BB	97	2510
TRR-2805-95-CC	97	1515
TRR-2805-95-GG	97	3902
TRR-2805-95-KK	97	2112
TRR-2805-95-LL	97	2510
TRR-2805-95-NN	97	2112
TRR-2805-95-TT	97	2708
TRR-2805-95-VV	97	2708
TRR-2805-95-YY	97	2112
TRR-2811-80-CC	272	1321
TRR-2811-80-KK	272	1860
TRR-2812-80-CC	273	1351
TRR-2812-80-KK	273	1899
TRR-2815-04-CC	80	1409
TRR-2815-04-KK	80	1974

CODE	PAGE	PRICE
TRR-2815-45-CC	146	1071
TRR-2815-45-KK	146	1535
TRR-2815-46-CC	161	1121
TRR-2815-46-KK	161	1600
TRR-2815-66-CC	208	1021
TRR-2815-95-CC	98	1221
TRR-2816-66-CC	209	871
TRR-2816-66-KK	209	1275
TRR-2826-66-CC	209	1021
TRR-2826-66-KK	209	1470
TRR-2891-80-BB	274	1769
TRR-2891-80-CC	274	1021
TRR-2891-80-GG	274	2815
TRR-2891-80-KK	274	1470
TRR-2891-80-LL	274	1769
TRR-2891-80-NN	274	1470
TRR-2891-80-TT	274	1918
TRR-2891-80-VV	274	1918
TRR-2891-80-YY	274	1470
TRR-2892-80-BB	275	1806
TRR-2892-80-CC	275	1046
TRR-2892-80-GG	275	2870
TRR-2892-80-KK	275	1502
TRR-2892-80-LL	275	1806
TRR-2892-80-NN	275	1502
TRR-2892-80-TT	275	1958
TRR-2892-80-VV	275	1958
TRR-2892-80-YY	275	1502
TRR-2896-04-BB	80	1919
TRR-2896-04-CC	80	1121
TRR-2896-04-GG	80	3035
TRR-2896-04-KK	80	1600
TRR-2896-04-LL	80	1919
TRR-2896-04-NN	80	1600
TRR-2896-04-TT	80	2078
TRR-2896-04-VV	80	2078
TRR-2896-04-YY	80	1600
TRR-2896-05-BB	98	2015
TRR-2896-05-CC	98	1185
TRR-2896-05-GG	98	3176
TRR-2896-05-KK	98	1683
TRR-2896-05-LL	98	2015
TRR-2896-05-NN	98	1683
TRR-2896-05-TT	98	2180
TRR-2896-05-VV	98	2180
TRR-2896-05-YY	98	1683
TRR-2896-45-BB	146	1889
TRR-2896-45-CC	146	1101
TRR-2896-45-GG	146	2991
TRR-2896-45-KK	146	1574
TRR-2896-45-LL	146	1889
TRR-2896-45-NN	146	1574
TRR-2896-45-TT	146	2046
TRR-2896-45-VV	146	2046
TRR-2896-45-YY	146	1574
TRR-2896-46-BB	161	1919
TRR-2896-46-CC	161	1121
TRR-2896-46-GG	161	3035

Finishes:

CC = chrome, CD = chrome diamond, CF = smokey chrome, KK = matte black, LL = satin brass, BB = white, NN = brushed nickel, YY = polished nickel, TT = venetian bronze, VV = satin copper, GG = gold, KM = black titanium, CB = chrome white, KB = matte black white, LB = satin brass white, NB = brushed nickel white, YB = polished nickel white, TB = venetian bronze, VB = satin copper white, GB = gold white

PRICE INDEX

CODE	PAGE	PRICE
TRR-2896-46-KK	161	1600
TRR-2896-46-LL	161	1919
TRR-2896-46-NN	161	1600
TRR-2896-46-TT	161	2078
TRR-2896-46-VV	161	2078
TRR-2896-46-YY	161	1600
TRR-2896-66-BB	209	1814
TRR-2896-66-CC	209	1051
TRR-2896-66-GG	209	2881
TRR-2896-66-KK	209	1509
TRR-2896-66-LL	209	1814
TRR-2896-66-NN	209	1509
TRR-2896-66-TT	209	1966
TRR-2896-66-VV	209	1966
TRR-2896-66-YY	209	1509
TRR-2901-80-CC	276	1446
TRR-2902-80-CC	277	1466
TRR-2915-04-CC	81	1528
TRR-2915-04-KK	81	2145
TRR-2915-45-CC	146	1190
TRR-2915-45-KK	146	1706
TRR-2915-66-CC	210	1146
TRR-3301-80-BB	278	2448
TRR-3301-80-CC	278	1316
TRR-3301-80-GG	278	4033
TRR-3301-80-KK	278	1995
TRR-3301-80-LL	278	2448
TRR-3301-80-NN	278	1995
TRR-3301-80-TT	278	2674
TRR-3301-80-VV	278	2674
TRR-3301-80-YY	278	1995
TRR-3302-04-BB	81	2577
TRR-3302-04-CC	81	1402
TRR-3302-04-GG	81	4222
TRR-3302-04-KK	81	2107
TRR-3302-04-LL	81	2577
TRR-3302-04-NN	81	2107
TRR-3302-04-TT	81	2812
TRR-3302-04-VV	81	2812
TRR-3302-04-YY	81	2107
TRR-3302-45-BB	147	2705
TRR-3302-45-CC	147	1487
TRR-3302-45-GG	147	4409
TRR-3302-45-KK	147	2218
TRR-3302-45-LL	147	2705
TRR-3302-45-NN	147	2218
TRR-3302-45-TT	147	2948
TRR-3302-45-VV	147	2948
TRR-3302-45-YY	147	2218
TRR-3302-46-BB	162	2495
TRR-3302-46-CC	162	1347
TRR-3302-46-GG	162	4101
TRR-3302-46-KK	162	2036
TRR-3302-46-LL	162	2495
TRR-3302-46-NN	162	2036
TRR-3302-46-TT	162	2724
TRR-3302-46-VV	162	2724
TRR-3302-46-YY	162	2036

CODE	PAGE	PRICE
TRR-3302-47-Bx	175	3845
TRR-3302-47-Cx	175	2247
TRR-3302-47-Gx	175	6081
TRR-3302-47-Kx	175	3206
TRR-3302-47-Lx	175	3845
TRR-3302-47-Nx	175	3206
TRR-3302-47-Tx	175	4164
TRR-3302-47-Vx	175	4164
TRR-3302-47-Yx	175	3206
TRR-3302-66-BB	210	2604
TRR-3302-66-CC	210	1420
TRR-3302-66-GG	210	4262
TRR-3302-66-KK	210	2130
TRR-3302-66-LL	210	2604
TRR-3302-66-NN	210	2130
TRR-3302-66-TT	210	2841
TRR-3302-66-VV	210	2841
TRR-3302-66-YY	210	2130
TRR-3302-80-BB	280	2495
TRR-3302-80-CC	280	1347
TRR-3302-80-GG	280	4101
TRR-3302-80-KK	280	2036
TRR-3302-80-LL	280	2495
TRR-3302-80-NN	280	2036
TRR-3302-80-TT	280	2724
TRR-3302-80-VV	280	2724
TRR-3302-80-YY	280	2036
TRR-3303-47-Bx	175	4145
TRR-3303-47-Cx	175	2420
TRR-3303-47-Gx	175	6560
TRR-3303-47-Kx	175	3455
TRR-3303-47-Lx	175	4145
TRR-3303-47-Nx	175	3455
TRR-3303-47-Tx	175	4490
TRR-3303-47-Vx	175	4490
TRR-3303-47-Yx	175	3455
TRR-3352-47-Bx	176	3830
TRR-3352-47-Cx	176	2237
TRR-3352-47-Gx	176	6059
TRR-3352-47-Kx	176	3193
TRR-3352-47-Lx	176	3830
TRR-3352-47-Nx	176	3193
TRR-3352-47-Tx	176	4148
TRR-3352-47-Vx	176	4148
TRR-3352-47-Yx	176	3193
TRR-3405-04-BB	81	2678
TRR-3405-04-CC	81	1458
TRR-3405-04-GG	81	4385
TRR-3405-04-KK	81	2190
TRR-3405-04-LL	81	2678
TRR-3405-04-NN	81	2190
TRR-3405-04-TT	81	2921
TRR-3405-04-VV	81	2921
TRR-3405-04-YY	81	2190
TRR-3405-05-BB	98	3137
TRR-3405-05-CC	98	1764
TRR-3405-05-GG	98	5058
TRR-3405-05-KK	98	2588

CODE	PAGE	PRICE
TRR-3405-05-LL	98	3137
TRR-3405-05-NN	98	2588
TRR-3405-05-TT	98	3411
TRR-3405-05-VV	98	3411
TRR-3405-05-YY	98	2588
TRR-3405-45-BB	147	2762
TRR-3405-45-CC	147	1514
TRR-3405-45-GG	147	4508
TRR-3405-45-KK	147	2263
TRR-3405-45-LL	147	2762
TRR-3405-45-NN	147	2263
TRR-3405-45-TT	147	3011
TRR-3405-45-VV	147	3011
TRR-3405-45-YY	147	2263
TRR-3405-66-BB	210	2462
TRR-3405-66-CC	210	1314
TRR-3405-66-GG	210	4068
TRR-3405-66-KK	210	2003
TRR-3405-66-LL	210	2462
TRR-3405-66-NN	210	2003
TRR-3405-66-TT	210	2691
TRR-3405-66-VV	210	2691
TRR-3405-66-YY	210	2003
TRR-3420-16-BB	115	2537
TRR-3420-16-CC	115	1364
TRR-3420-16-GG	115	4178
TRR-3420-16-KK	115	2068
TRR-3420-16-LL	115	2537
TRR-3420-16-NN	115	2068
TRR-3420-16-TT	115	2771
TRR-3420-16-VV	115	2771
TRR-3420-16-YY	115	2068
TRR-3420-18-BB	116	2537
TRR-3420-18-CB	116	1364
TRR-3420-18-CC	116	1364
TRR-3420-18-GB	116	4178
TRR-3420-18-GG	116	4178
TRR-3420-18-KB	116	2068
TRR-3420-18-KK	116	2068
TRR-3420-18-LB	116	2537
TRR-3420-18-LL	116	2537
TRR-3420-18-NB	116	2068
TRR-3420-18-NN	116	2068
TRR-3420-18-TB	116	2771
TRR-3420-18-TT	116	2771
TRR-3420-18-VB	116	2771
TRR-3420-18-VV	116	2771
TRR-3420-18-YB	116	2068
TRR-3420-18-YY	116	2068
TRR-3420-26-CD	123	2814
TRR-3420-27-BB	124	3399
TRR-3420-27-CC	124	1939
TRR-3420-27-GG	124	5443
TRR-3420-27-KK	124	2815
TRR-3420-27-LL	124	3399
TRR-3420-27-NN	124	2815
TRR-3420-27-TT	124	3691
TRR-3420-27-VV	124	3691

Actual products may differ from pictures. Actual products measures may differ from the measures shown. All USD prices are subject to change without notice. Effective as of August 2023.

PRICE INDEX

CODE	PAGE	PRICE
TRR-3420-27-YY	124	2815
TRR-3420-28-BB	124	3399
TRR-3420-28-CC	124	1939
TRR-3420-28-GG	124	5443
TRR-3420-28-KK	124	2815
TRR-3420-28-LL	124	3399
TRR-3420-28-NN	124	2815
TRR-3420-28-TT	124	3691
TRR-3420-28-VV	124	3691
TRR-3420-28-YY	124	2815
TRR-3420-71-BB	221	3144
TRR-3420-71-CC	221	1769
TRR-3420-71-GG	221	5069
TRR-3420-71-KK	221	2594
TRR-3420-71-LL	221	3144
TRR-3420-71-NN	221	2594
TRR-3420-71-TT	221	3419
TRR-3420-71-VV	221	3419
TRR-3420-71-YY	221	2594
TRR-3420-72-BB	222	3144
TRR-3420-72-CC	222	1769
TRR-3420-72-GG	222	5069
TRR-3420-72-KK	222	2594
TRR-3420-72-LL	222	3144
TRR-3420-72-NN	222	2594
TRR-3420-72-TT	222	3419
TRR-3420-72-VV	222	3419
TRR-3420-72-YY	222	2594
TRR-3420-74-BB	229	3144
TRR-3420-74-CB	229	1769
TRR-3420-74-GB	229	5069
TRR-3420-74-KB	229	2594
TRR-3420-74-LB	229	3144
TRR-3420-74-NB	229	2594
TRR-3420-74-TB	229	3419
TRR-3420-74-VB	229	3419
TRR-3420-74-YB	229	2594
TRR-3950-04-BB	82	4306
TRR-3950-04-CC	82	2408
TRR-3950-04-GG	82	6962
TRR-3950-04-KK	82	3547
TRR-3950-04-LL	82	4306
TRR-3950-04-NN	82	3547
TRR-3950-04-TT	82	4685
TRR-3950-04-VV	82	4685
TRR-3950-04-YY	82	3547
TRR-3950-46-BB	162	5041
TRR-3950-46-CC	162	2898
TRR-3950-46-GG	162	8040
TRR-3950-46-KK	162	4184
TRR-3950-46-LL	162	5041
TRR-3950-46-NN	162	4184
TRR-3950-46-TT	162	5469
TRR-3950-46-VV	162	5469
TRR-3950-46-YY	162	4184
TRR-3950-56-CB	191	3688
TRR-3950-56-CC	191	3688
TRR-3950-56-CF	191	3688

CODE	PAGE	PRICE
TRR-4201-66-BB	211	2150
TRR-4201-66-CC	211	1205
TRR-4201-66-GG	211	3473
TRR-4201-66-KK	211	1772
TRR-4201-66-LL	211	2150
TRR-4201-66-NN	211	1772
TRR-4201-66-TT	211	2339
TRR-4201-66-VV	211	2339
TRR-4201-66-YY	211	1772
TRR-4201-80-BB	284	2383
TRR-4201-80-CC	284	1360
TRR-4201-80-GG	284	3814
TRR-4201-80-KK	284	1974
TRR-4201-80-LL	284	2383
TRR-4201-80-NN	284	1974
TRR-4201-80-TT	284	2587
TRR-4201-80-VV	284	2587
TRR-4201-80-YY	284	1974
TRR-4202-80-BB	285	2480
TRR-4202-80-CC	285	1425
TRR-4202-80-GG	285	3957
TRR-4202-80-KK	285	2058
TRR-4202-80-LL	285	2480
TRR-4202-80-NN	285	2058
TRR-4202-80-TT	285	2691
TRR-4202-80-VV	285	2691
TRR-4202-80-YY	285	2058
TRR-4205-04-BB	82	2330
TRR-4205-04-CC	82	1325
TRR-4205-04-GG	82	3737
TRR-4205-04-KK	82	1928
TRR-4205-04-KM	82	2531
TRR-4205-04-LL	82	2330
TRR-4205-04-NN	82	1928
TRR-4205-04-TT	82	2531
TRR-4205-04-VV	82	2531
TRR-4205-04-YY	82	1928
TRR-4206-05-BB	99	2480
TRR-4206-05-CC	99	1425
TRR-4206-05-GG	99	3957
TRR-4206-05-KK	99	2058
TRR-4206-05-LL	99	2480
TRR-4206-05-NN	99	2058
TRR-4206-05-TT	99	2691
TRR-4206-05-VV	99	2691
TRR-4206-05-YY	99	2058
TRR-4206-45-BB	147	2233
TRR-4206-45-CC	147	1260
TRR-4206-45-GG	147	3594
TRR-4206-45-KK	147	1844
TRR-4206-45-LL	147	2233
TRR-4206-45-NN	147	1844
TRR-4206-45-TT	147	2427
TRR-4206-45-VV	147	2427
TRR-4206-45-YY	147	1844
TRR-4206-46-BB	162	2518
TRR-4206-46-CC	162	1450
TRR-4206-46-GG	162	4012

CODE	PAGE	PRICE
TRR-4206-46-KK	162	2091
TRR-4206-46-LL	162	2518
TRR-4206-46-NN	162	2091
TRR-4206-46-TT	162	2731
TRR-4206-46-VV	162	2731
TRR-4206-46-YY	162	2091
TRR-4206-66-BB	211	2000
TRR-4206-66-CC	211	1105
TRR-4206-66-GG	211	3253
TRR-4206-66-KK	211	1642
TRR-4206-66-LL	211	2000
TRR-4206-66-NN	211	1642
TRR-4206-66-TT	211	2179
TRR-4206-66-VV	211	2179
TRR-4206-66-YY	211	1642
TRR-4211-80-CC	286	1390
TRR-4211-80-KK	286	2013
TRR-4212-80-CC	287	1440
TRR-4212-80-KK	287	2078
TRR-4215-04-CC	82	1440
TRR-4215-04-KK	82	2078
TRR-4216-05-CC	99	1540
TRR-4216-05-KK	99	2208
TRR-4216-45-CC	148	1110
TRR-4216-45-KK	148	1649
TRR-4216-46-CC	163	1347
TRR-4216-51-BB	183	2983
TRR-4216-51-CC	183	1760
TRR-4216-51-CF	183	1760
TRR-4216-51-KK	183	2494
TRR-4216-66-CC	211	915
TRR-4216-66-KK	211	1395
TRR-4225-05-CC	99	1684
TRR-4226-46-BB	163	2713
TRR-4226-46-CC	163	1580
TRR-4226-46-GG	163	4298
TRR-4226-46-KK	163	2260
TRR-4226-46-LL	163	2713
TRR-4226-46-NN	163	2260
TRR-4226-46-TT	163	2939
TRR-4226-46-VV	163	2939
TRR-4226-46-YY	163	2260
TRR-4226-56-CB	191	2083
TRR-4226-56-CC	191	2083
TRR-4226-56-CF	191	2083
TRR-4236-56-CB	192	2447
TRR-4236-56-CC	192	2447
TRR-4236-56-CF	192	2447
TRR-4255-56-CB	192	2390
TRR-4255-56-CC	192	2390
TRR-4255-56-CF	192	2390
TRR-4291-51-BB	183	2878
TRR-4291-51-CC	183	1690
TRR-4291-51-CF	183	1690
TRR-4291-51-KK	183	2403
TRR-4291-80-BB	288	2006
TRR-4291-80-CC	288	1109
TRR-4291-80-GG	288	3262

Finishes:

CC = chrome, CD = chrome diamond, CF = smokey chrome, KK = matte black, LL = satin brass, BB = white, NN = brushed nickel, YY = polished nickel, TT = venetian bronze, VV = satin copper, GG = gold, KM = black titanium, CB = chrome white, KB = matte black white, LB = satin brass white, NB = brushed nickel white, YB = polished nickel white, TB = venetian bronze, VB = satin copper white, GB = gold white

PRICE INDEX

CODE	PAGE	PRICE
TRR-4291-80-KK	288	1647
TRR-4291-80-LL	288	2006
TRR-4291-80-NN	288	1647
TRR-4291-80-TT	288	2185
TRR-4291-80-VV	288	2185
TRR-4291-80-YY	288	1647
TRR-4292-80-BB	289	2105
TRR-4292-80-CC	289	1175
TRR-4292-80-GG	289	3407
TRR-4292-80-KK	289	1733
TRR-4292-80-LL	289	2105
TRR-4292-80-NN	289	1733
TRR-4292-80-TT	289	2291
TRR-4292-80-VV	289	2291
TRR-4292-80-YY	289	1733
TRR-4296-04-BB	83	1951
TRR-4296-04-CC	83	1072
TRR-4296-04-GG	83	3180
TRR-4296-04-KK	83	1599
TRR-4296-04-LL	83	1951
TRR-4296-04-NN	83	1599
TRR-4296-04-TT	83	2126
TRR-4296-04-VV	83	2126
TRR-4296-04-YY	83	1599
TRR-4296-05-BB	100	2246
TRR-4296-05-CC	100	1269
TRR-4296-05-GG	100	3614
TRR-4296-05-KK	100	1855
TRR-4296-05-LL	100	2246
TRR-4296-05-NN	100	1855
TRR-4296-05-TT	100	2441
TRR-4296-05-VV	100	2441
TRR-4296-05-YY	100	1855
TRR-4296-46-BB	164	2149
TRR-4296-46-CC	164	1204
TRR-4296-46-GG	164	3471
TRR-4296-46-KK	164	1771
TRR-4296-46-LL	164	2149
TRR-4296-46-NN	164	1771
TRR-4296-46-TT	164	2337
TRR-4296-46-VV	164	2337
TRR-4296-46-YY	164	1771
TRR-4296-56-CB	193	1510
TRR-4296-56-CC	193	1510
TRR-4296-56-CF	193	1510
TRR-4297-45-BB	148	1858
TRR-4297-45-CC	148	1010
TRR-4297-45-GG	148	3044
TRR-4297-45-KK	148	1519
TRR-4297-45-LL	148	1858
TRR-4297-45-NN	148	1519
TRR-4297-45-TT	148	2027
TRR-4297-45-VV	148	2027
TRR-4297-45-YY	148	1519
TRR-4297-66-BB	212	1768
TRR-4297-66-CC	212	950
TRR-4297-66-GG	212	2912
TRR-4297-66-KK	212	1441

CODE	PAGE	PRICE
TRR-4297-66-LL	212	1768
TRR-4297-66-NN	212	1441
TRR-4297-66-TT	212	1931
TRR-4297-66-VV	212	1931
TRR-4297-66-YY	212	1441
TRR-4301-80-BB	290	2678
TRR-4301-80-CC	290	1520
TRR-4301-80-GG	290	4298
TRR-4301-80-KK	290	2215
TRR-4301-80-LL	290	2678
TRR-4301-80-NN	290	2215
TRR-4301-80-TT	290	2909
TRR-4301-80-VV	290	2909
TRR-4301-80-YY	290	2215
TRR-4302-66-BB	212	2444
TRR-4302-66-CC	212	1364
TRR-4302-66-GG	212	3955
TRR-4302-66-KK	212	2012
TRR-4302-66-LL	212	2444
TRR-4302-66-NN	212	2012
TRR-4302-66-TT	212	2659
TRR-4302-66-VV	212	2659
TRR-4302-66-YY	212	2012
TRR-4302-80-BB	291	2775
TRR-4302-80-CC	291	1585
TRR-4302-80-GG	291	4441
TRR-4302-80-KK	291	2299
TRR-4302-80-LL	291	2775
TRR-4302-80-NN	291	2299
TRR-4302-80-TT	291	3013
TRR-4302-80-VV	291	3013
TRR-4302-80-YY	291	2299
TRR-4305-04-BB	83	2946
TRR-4305-04-CC	83	1699
TRR-4305-04-GG	83	4692
TRR-4305-04-KK	83	2447
TRR-4305-04-KM	83	3195
TRR-4305-04-LL	83	2946
TRR-4305-04-NN	83	2447
TRR-4305-04-TT	83	3195
TRR-4305-04-VV	83	3195
TRR-4305-04-YY	83	2447
TRR-4306-05-BB	100	2985
TRR-4306-05-CC	100	1725
TRR-4306-05-GG	100	4749
TRR-4306-05-KK	100	2481
TRR-4306-05-LL	100	2985
TRR-4306-05-NN	100	2481
TRR-4306-05-TT	100	3237
TRR-4306-05-VV	100	3237
TRR-4306-05-YY	100	2481
TRR-4306-45-BB	148	2835
TRR-4306-45-CC	148	1625
TRR-4306-45-GG	148	4529
TRR-4306-45-KK	148	2351
TRR-4306-45-LL	148	2835
TRR-4306-45-NN	148	2351
TRR-4306-45-TT	148	3077

CODE	PAGE	PRICE
TRR-4306-45-VV	148	3077
TRR-4306-45-YY	148	2351
TRR-4306-46-BB	164	3134
TRR-4306-46-CC	164	1824
TRR-4306-46-GG	164	4967
TRR-4306-46-KK	164	2610
TRR-4306-46-LL	164	3134
TRR-4306-46-NN	164	2610
TRR-4306-46-TT	164	3395
TRR-4306-46-VV	164	3395
TRR-4306-46-YY	164	2610
TRR-4306-66-BB	212	2295
TRR-4306-66-CC	212	1265
TRR-4306-66-GG	212	3737
TRR-4306-66-KK	212	1883
TRR-4306-66-LL	212	2295
TRR-4306-66-NN	212	1883
TRR-4306-66-TT	212	2501
TRR-4306-66-VV	212	2501
TRR-4306-66-YY	212	1883
TRR-4316-04-CC	84	1850
TRR-4316-04-KK	84	2644
TRR-4316-66-CC	213	1100
TRR-4316-66-KK	213	1669
TRR-4326-56-CB	193	2493
TRR-4326-56-CC	193	2493
TRR-4326-56-CF	193	2493
TRR-4394-66-BB	213	3057
TRR-4394-66-CC	213	1773
TRR-4394-66-GG	213	4855
TRR-4394-66-KK	213	2543
TRR-4394-66-LL	213	3057
TRR-4394-66-NN	213	2543
TRR-4394-66-TT	213	3314
TRR-4394-66-VV	213	3314
TRR-4394-66-YY	213	2543
TRR-4395-05-BB	100	3818
TRR-4395-05-CC	100	2280
TRR-4395-05-GG	100	5970
TRR-4395-05-KK	100	3203
TRR-4395-05-LL	100	3818
TRR-4395-05-NN	100	3203
TRR-4395-05-TT	100	4125
TRR-4395-05-VV	100	4125
TRR-4395-05-YY	100	3203
VAL-2615-01-CC	343	850
VAL-2615-01-NN	343	1104
VAL-2650-00-BB	343	1047
VAL-2650-00-CC	343	698
VAL-2650-00-GG	343	1536
VAL-2650-00-KK	343	907
VAL-2650-00-LL	343	1047
VAL-2650-00-NN	343	907
VAL-2650-00-TT	343	1117
VAL-2650-00-VV	343	1117
VAL-2650-00-YY	343	907

Actual products may differ from pictures. Actual products measures may differ from the measures shown. All USD prices are subject to change without notice. Effective as of August 2023.

BARILDESIGN.COM

1 800 463.3871
1 877 693.3005 [fax]
info@barildesign.com

   @barildesign

MONTREAL | DESIGN STUDIO

5394, blvd. St-Laurent
Montreal (Quebec)
Canada H2T 1S1

TROIS-RIVIERES | HEAD OFFICE

579, blvd. Ste-Madeleine
Trois-Rivieres (Quebec)
Canada G8T 9J8

BARILDESIGN.COM

1 800 463.3871
1 877 693.3005 [fax]
info@barildesign.com

   @barildesign

MONTREAL | DESIGN STUDIO

5394, blvd. St-Laurent
Montreal (Quebec)
Canada H2T 1S1

TROIS-RIVIERES | HEAD OFFICE

579, blvd. Ste-Madeleine
Trois-Rivieres (Quebec)
Canada G8T 9J8