

FRANKE

Vol. 2024/2025



COLLECTIONS 2024

FRANKE

FRANKE

Franke Home Solutions
800 Aviation Parkway
Smyrna, TN 37167
franke.com

COLLECTIONS 2024

FAMILIES

- 12 Mythos
- 20 Maris

PRODUCT CATEGORIES

- Sinks**
 - 32 Stainless Steel
 - 110 Granite
 - 152 Fireclay
- Faucets**
 - 168 Faucets
 - 202 Filtration
- 214 Kitchen Solutions - Accessories
- 234 Charts and Index





Years of experience, yet still as curious as kids.

At Franke, we have been looking for new solutions and innovations for over 100 years and our attitude still has not changed. In 1911 we combined traditional craftsmanship, precision engineering and a constant pursuit of innovation, three principles that remain at our core.

A story forged in Swiss precision

Our story began at the beginning of the last century as a small sheet-metal business in Rorschach, Switzerland, established by Hermann Franke. Since then, we opened up to the world and inaugurated manufacturing facilities all around the globe that led us to become leaders in the kitchen sinks segment, and home solutions altogether.



The recipe for a healthier future

We're on a mission to help create a more sustainable planet, one innovation at a time. From designs built with the use of sustainable materials, to efficiency optimization and waste reduction, we act responsibly throughout our business and beyond for positive long-term impact.



Taking care of the environment

Franke joined the United Nations Global Compact and adopted the Ten Principles of the United Nations Global Compact for sustainable and responsible business in 2011 and has reported on its material sustainability impacts annually since.

By 2050, we hope to have achieved Net Zero emissions throughout the entire production chain and from localized actions we're already on target with our company CO₂ emissions falling 10% annually since 2016.

Our eco-conscious attitude doesn't stop with emissions; we're forever evolving our manufacturing processes to reduce impact on the environment and lead by example.

Resources

59% of electric consumption in 2022 came from renewable energy, 6% of which was created by solar energy generated on Franke owned sites.

Water consumption decreased by 18.6% in 2022.

Franke Group's consumption of natural gas reduced by 17.5% in 2022.

Nurturing our people and society

The health of our people and communities is just as important as our planet. That's why we provide leadership training courses throughout our company and aim to make this available for every employee by 2030. We also partner with national and international organizations, volunteering where possible in support of social issues.

“ We have invested in more solar PV systems, with the capacity to generate around 2,500,000 kWh annually ”

Patrik Wohlhauser, Franke CEO

Innovation for sustainable living

Our eco-friendly innovations are designed to empower cleaner living at home and inspire everyday well being.

Faucets

Franke stainless steel faucet models are made of 100% recyclable steel. In addition, some faucets offer the water-saving feature. This innovative technology allows you to move the handle to a position that will reduce water flow by 50%. In addition, faucets equipped with Franke's ECO cartridge are designed to limit the flow and temperature of the water.



Filtration

Plastic bottles have a particularly stark effect on the environment — around the world, over 1,500 bottles end up in the sea every second. From our point-of-use faucets, the filter combines activated carbon and a high-tech membrane to reduce bacteria, lead, chlorine, residues and sediment. Customers, therefore, have clean drinking water, which is equally good for their health and the environment.



Sinks

Franke's sinks are exemplary in terms of usage of sustainable materials such as stainless steel, granite and ceramic that guarantee extraordinary product durability, resistance and long-lasting quality.



FRANKE



HOME SOLUTIONS

Solutions that work together

Our kitchens are places to live: We cook there, eat there and spend time together there, more often than not, all at the same time. Our products all merge together in functional systems aimed to facilitate your life and please your eye, thanks to perfectly matching colors, designs and combinations. When everything comes together, it is easier to enjoy every moment.

Food preparation areas

Faucets, sinks and kitchen accessories

Award-winning, intelligent, eco-friendly faucets are perfectly paired with elegant, spacious sinks equipped with custom-fit accessories or other innovative tools, so you have everything you always need. Everything is manufactured in the best, most durable and hygienic materials, such as our stainless steel or exclusive granite.



Filtration

Cold, hot and hot/cold combinations

Franke filtration faucets are the epitome of premium quality faucets that are meticulously crafted with lead-free stainless steel, both internally and externally, setting the standard for exceptional faucets.

Inspir

There is no place like home. And there are no two homes alike. The way we cherish our own nest is just as unique as we are, each one with different tastes, preferences and needs. To help you get inspired and create the kitchen environment of your dreams, and enjoy it every day, we developed two different **families** of products.

Mythos

A passion for the best

Our most premium range. Technology meets design, while even the smallest details are carefully sought-after. This **family** sets its goal to the highest levels, combining the very essence of functionality with that of beauty.

Maris

Family in the kitchen

A **family** inspired by families. Cozy and functional, for savoring the heartwarming experience of a **family** get-together. Maris' philosophy is simple: welcome anyone, anytime with the pride and joy of a homemade dinner.

What your kitchen will look like is up to you, but whatever your way of bringing joy home, **you can count on us.**

ations





Sink: Mythos Masterpiece - MMX11027-ANT-WKC

Mythos



Faucet: Eos Neo - Pull-Down Spray EOS-PD-ANT
Soap Dispenser: Atlas - ATL-SD-ANT

Mythos Masterpiece

NEW

Add an artful finishing touch
with Mythos Masterpiece



Express yourself with the Mythos Masterpiece collection, a specially curated selection of handmade sinks, coordinating faucets, soap dispensers and accessories all produced in a choice of two on-trend metallic color choices to bring an elegant, artful look to your kitchen and home.

Stunning and sophisticated, each example beautifully blends exceptional aesthetics with uncompromising quality, giving you the freedom to create a look like no other.

Manufactured from hardwearing, hygienic stainless steel, our Mythos Masterpiece sinks reflect our reputation for exceptional quality and extraordinary expertise in pioneering the production of such products since 1911.

Colors

- Anthracite
- Gold



NEW

Faucets, soap dispensers and accessories to really complete the look

Showing off your creative side doesn't have to stop at the sink. Because the Mythos Masterpiece collection also includes our Eos Neo faucets plus the Atlas soap dispenser in the same duo of metallic finishes.

Match components in the same shade for a perfectly aligned look. Or mix things up to create a combination that's uniquely yours. You can also take your pick from our range of matching components, with colanders, roller mats, strainer baskets and food waste disposer flanges available in the same metallic shades.

Match components in the same shade or add contrast ...

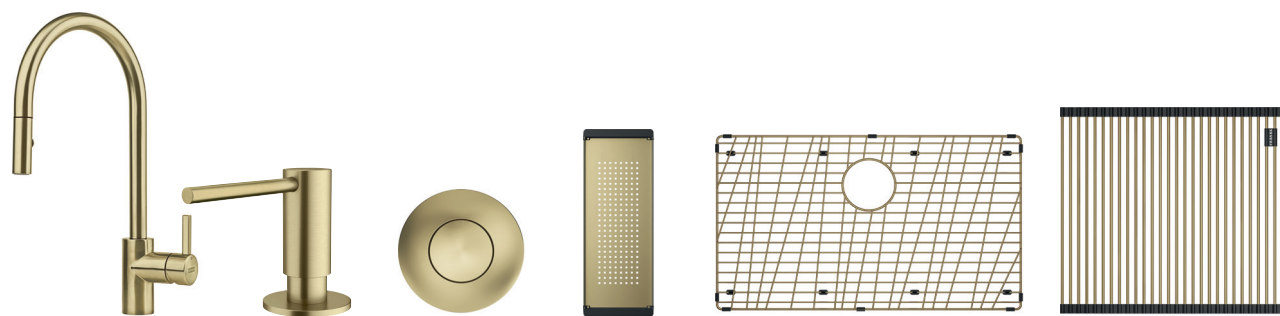

Mythos Masterpiece



Faucet: Centinox - CEN-SP-304

Mythos



Sink: Pescara - PTX110-31

Accessory: Roller Mat - UV-36RM



Sink: Maris - MAG11028-ONY

Maris



Faucet: Active - ACT-PO-ONY



Maris



Sink: Cube - CUX110-30



Faucet: Active - ACT-PO-CHR



Maris Granite

NEW

Elevate your kitchen with
versatile Slate Grey



Introducing Franke's newest color addition to our granite sink family: Slate Grey. This rich and deep color is set to balance the bright and light shades that will dominate this year. From deep greys to captivating blacks and warm Champagne, our range of colors offers endless possibilities for personal self-expression.

When it comes to choosing the perfect shade for your kitchen, it ultimately comes down to personal preference. Slate Grey, with its intriguing blend of greys, is a timeless color that will never go out of style. Its versatility allows for easy pairing with high contrast or softer muted colors, instantly elevating any kitchen space.

Redefine color with Franke's Slate Grey granite sinks and explore our variety of shades that are perfect for any kitchen.



Polar White Stone Grey **NEW** Slate Grey Onyx Matte Black



Champagne Oyster Mocha

Show what you're made of!

Shiny or matte, smooth or stone-like, extra-strong or super trendy. Your kitchen can speak volumes about you, so every detail counts. To offer you the chance to create your very own perfect kitchen, our range of materials is designed to please any taste, match any style and resist any endeavor. Discover each material's precision-engineered character and unique benefits to choose the one that suits your needs the best and you like the most.

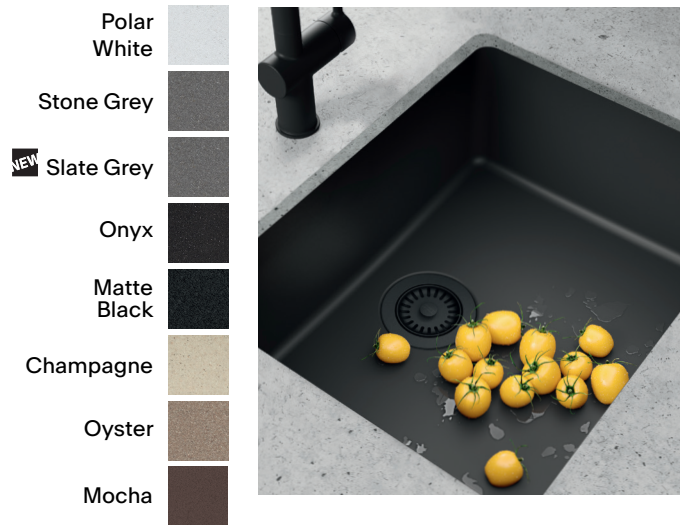

Granite



An exceptionally tough material, highly resistant to heat, scratches, chips and stains. Franke has been making granite for over 35 years, and it's a unique material with a subtle sheen thanks to its 80% quartz blend. Also, only Franke's granite is enhanced with Sanitized® technology during the manufacturing process, which reduces bacteria and microbe growth by 99%. A relevant feature for our kitchens as bacteria can multiply every 20 minutes making the kitchen's surfaces highly unhygienic.



F-Inox Technology

An exclusive Franke coating able to group water molecules, allowing you to dry your sink without ring stains. Water repellent and scratch-resistant, this futuristic coating also fears no heat up to 350° F. A real and long-lasting beauty formula that you can appreciate from our Mythos Masterpiece family.

Stainless Steel

Whether you prefer the more reflective qualities of the diamond finish or the more subtle look of the silk or pearl finishes, which give a more matte sheen, there is a Stainless Steel solution for you. All Franke Stainless Steel products are made from premium quality chrome nickel steel, which looks stunning and is highly resistant to staining, rust and corrosion. Stainless Steel is one of the most popular materials in the kitchen for a good reason.

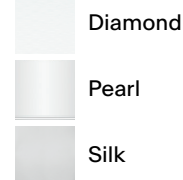

PVD Coating

PVD, standing for "Physical Vapor Deposition," is a coating technology that makes faucets even more resistant to abrasions, scratches and corrosion and offers exceptional aesthetic features as well. A faucet treated with a PVD coating even resists UV rays and makes fingerprints less visible in a busy kitchen. PVD coating is available in two exquisite finishes: Anthracite and Gold. Franke goes beyond expectations by providing a wide range of other captivating finishes. Our solid Stainless Steel not only adds elegance but also ensures long-lasting durability. For a sleek modern look, our Anthracite Stainless Steel is ideal.

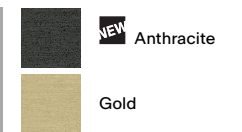

Fireclay

Fireclay sinks have a smooth, impervious surface, which stands up to heat, staining, impacts and resists standard household chemicals with ease. Fireclay sinks have been a popular choice for years and create a classic combination with a variety of work surfaces such as wood, glass and granite.

Quality

in shining armor.

Beautiful and made for real-life use. Stainless Steel represents our ideal kitchen.

The sheer quality of Franke products can be seen and felt. We use AISI 304 18/10 stainless steel, a choice that reflects our dedication to quality, one of our core priorities over the 100-plus years of our history.

Strong and robust, it maintains its brilliance over time, making it the defining feature of the living spaces in which it is installed.

Its superb technical features ensure that it is always in demand and highly appreciated by professionals in the haute cuisine sector. Furthermore, Stainless Steel is an extremely hygienic material, and is easy-to-clean and recyclable. Aesthetically pleasing and functional to use: Stainless Steel really represents quality in shining armor.

Durable

The specific concentrations of nickel and chrome in AISI 304 18/10 stainless steel render it particularly resistant to extreme temperatures. Its brilliance does not fade over time; on the contrary, its beauty and appeal only increase.

Easy to maintain

Stainless Steel is easy to maintain; just a few simple daily steps ensure that it remains a joy to use over time.

Functional

Stainless Steel is the material of choice for kitchen professionals, due to the fact that it is resistant, hygienic and safe. Its non-porous surface is extremely easy-to-clean.

Sustainable and ecological

An environmentally friendly material that is 100% recyclable, can be sourced from scrap material, and produced without toxic waste.

The top of Assistance if ever needed.

A 360° guarantee on the entire family

Our commitment to providing the highest quality products means that you are unlikely to ever need our assistance. However, if you do encounter any issues, we will be there for you. All our products come with warranties, ensuring peace of mind for our customers when choosing Franke products for their kitchens.

Customer Care and Technical Assistance

If you ever experience a problem with any Franke product, simply contact our Customer Service at 1-800-626-5771. Our dedicated customer care team will be the first to assist you, offering advice and instructions to resolve the issue. If necessary, we will escalate the matter to the relevant Franke team members to ensure a prompt solution and restore the product's functionality through a replacement part or warranty replacement. Your satisfaction is our top priority, so rest assured that we are here to help.

For more information
and for details on warranty
conditions: www.franke.com

US: 1-800-626-5771



Stainless Steel Sinks



- 34 Mythos Masterpiece **NEW**
- 40 Culinary Center
- 44 Workcenters
- 52 Peak
- 60 Professional
- 70 Crystal
- 74 Pescara
- 82 Orca 2.0
- 86 Prestige
- 88 Regatta
- 90 Cube
- 98 Cube ADA
- 100 Grande
- 106 Rotondo
- 108 Outdoor Series



Mythos Masterpiece

Your latest work of art.

NEW



Bring an elegant, artful look to your kitchen and home with the on-trend metallic colors of our latest Mythos Masterpiece collection. A curated selection of sinks, including faucets, soap dispensers, strainer baskets and accessories that blends exceptional aesthetics with uncompromising quality, allowing your kitchen to have a unique look like no other.



Eos Neo with pull down spray



Atlas Soap Dispenser

Exclusive to the Mythos Masterpiece sinks

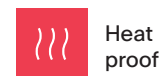

Discover F-Inox, an exclusive Franke coating that groups water molecules and allows you to dry your sink without ring stains. This unique coating not only helps to prevent fingerprints and marks, but also makes the sink easier to clean.

Discover more about the **F-Inox Technology:**



Elegant, distinctive and modern, prepare to make your mark

For an even more distinctive look, the Mythos Masterpiece collection also offers accessories that give you a little more. A unique bottom grid that protects the sink, a roller mat for heat protection and a separate colander for meal preparation.

Bottom grid for protection

For further protection, every sink is also supplied with a required coordinating wire grid. Perfectly matching your chosen finish, this is designed to stop pots and pans from scratching the bottom of the sink, preserving its looks long-term.



Show your true colors

Whether you prefer the boldness of Anthracite or the sparkling luxury of Gold, the Mythos Masterpiece collection lets you show your true colors with distinctive modern finishes that showcase your style.

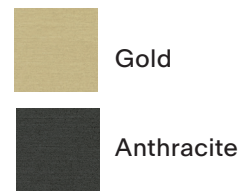

Eos Neo
Faucet
EOS-PD-GLD



Atlas Soap
Dispenser
ATL-SD-GLD



Air Switch
WD3428GLD



Flange Kit
WDFLANGE-GLD



Strainer
906-GLD



Colander
MM-70S-GLD

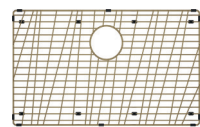

Bottom
Grid
MM27-36S-GLD

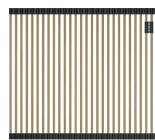

Roller
Mat
MM-31RM-GLD



Eos Neo
Faucet
EOS-PD-ANT



Atlas Soap
Dispenser
ATL-SD-ANT



Air Switch
WD3428ANT



Flange Kit
WDFLANGE-ANT



Strainer
906-ANT



Colander
MM-70S-ANT

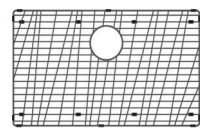

Bottom
Grid
MM27-36S-ANT

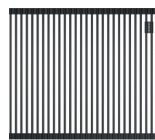

Roller
Mat
MM-31RM-ANT



MYTHOS

Mythos Masterpiece



NEW **MMX11015-ANT-WKC**
122.0703.644
\$2,700

Interior Dimensions: 15³/₄" x 16¹/₈" x 8³/₁₆"
Exterior Dimensions: 17⁵/₁₆" x 17³/₄"
Minimum Cabinet Size: 21"
Gauge: 19
Weight: 10 lbs.
Sound Dampening: Sound Pad
Stainless Finish: F-Inox Coating
Corner Radius: 12 mm
Installation: Undermount

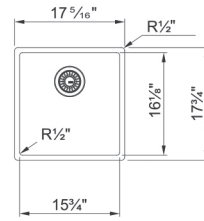

Accessories Included

A1

Accessories Optional

O1 O2 O3 O4 O5 O6

MYTHOS

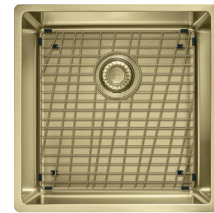

NEW **MMX11015-GLD-WKC**
122.0703.645
\$2,700

Interior Dimensions: 15³/₄" x 16¹/₈" x 8³/₁₆"
Exterior Dimensions: 17⁵/₁₆" x 17³/₄"
Minimum Cabinet Size: 21"
Gauge: 19
Weight: 10 lbs.
Sound Dampening: Sound Pad
Stainless Finish: F-Inox Coating
Corner Radius: 12 mm
Installation: Undermount

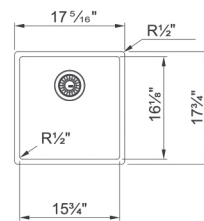

Accessories Included

A1

Accessories Optional

O1 O2 O3 O4 O5 O6

ACCESSORIES INCLUDED

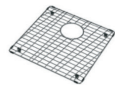

A1 Bottom Grid
15" x 15"
Anthracite
MM15-36S-ANT
112.0655.431
Gold
MM15-36S-GLD
112.0655.433
\$255

ACCESSORIES OPTIONAL



O1 Flange Kit
WDFLANGE-ANT
112.0664.350
WDFLANGE-GLD
112.0664.391
\$140



O2 Air Switch
WD3428ANT
112.0664.346
WD3428GLD
112.0664.347
\$55



O3 Strainer Basket
906-ANT
112.0630.003
906-GLD
112.0629.750
\$200

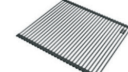

O4 Roller Mat
18³/₁₆" x 17³/₁₆"
Anthracite
MM-31RM-ANT
112.0655.342
Gold
MM-31RM-GLD
112.0655.240
\$375



O5 Colander
6³/₁₆" x 16¹/₈"
Anthracite
MM-70S-ANT
112.0655.239
Gold
MM-70S-GLD
112.0655.240
\$370



O6 Cutting Board
9⁷/₁₆" x 16¹/₈"
MM-40S
112.0676.854
\$275

MYTHOS

Mythos Masterpiece



NEW **MMX11027-GLD-WKC**
122.0703.647
\$3,750

Interior Dimensions: 27" x 16¹/₈" x 8³/₁₆"
Exterior Dimensions: 28¹/₂" x 17³/₄"
Minimum Cabinet Size: 33"
Gauge: 19
Weight: 14 lbs.
Sound Dampening: Sound Pad & Spray Coat
Stainless Finish: F-Inox Coating
Corner Radius: 12 mm
Installation: Undermount

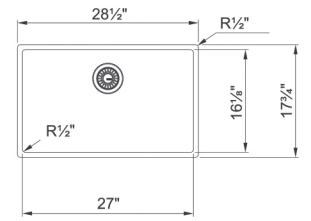

Accessories Included

A1 A2 A3 A4

Accessories Optional

O1 O2 O3

MYTHOS



NEW **MMX11027-ANT-WKC**
122.0703.646
\$3,750

Interior Dimensions: 27" x 16¹/₈" x 8³/₁₆"
Exterior Dimensions: 28¹/₂" x 17³/₄"
Minimum Cabinet Size: 33"
Gauge: 19
Weight: 14 lbs.
Sound Dampening: Sound Pad & Spray Coat
Stainless Finish: F-Inox Coating
Corner Radius: 12 mm
Installation: Undermount

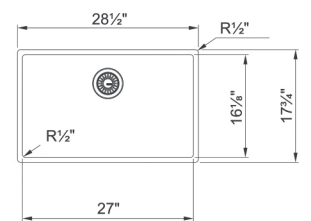

Accessories Included

A1 A2 A3 A4

Accessories Optional

O1 O2 O3

ACCESSORIES INCLUDED



A1 Bottom Grid
26⁹/₁₆" x 15¹/₄"
Anthracite
MM27-36S-ANT
112.0655.408
Gold
MM27-36S-GLD
112.0655.409
\$400

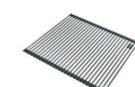

A2 Roller Mat
18³/₁₆" x 17³/₁₆"
Anthracite
MM-31RM-ANT
112.0655.342
Gold
MM-31RM-GLD
112.0655.343
\$375



A3 Colander
6³/₁₆" x 16¹/₈"
Anthracite
MM-70S-ANT
112.0655.239
Gold
MM-70S-GLD
112.0655.240
\$370



A4 Cutting Board
9⁷/₁₆" x 16¹/₈"
MM-40S
112.0676.854
\$275

ACCESSORIES OPTIONAL



O1 Flange Kit
WDFLANGE-ANT
112.0664.350
WDFLANGE-GLD
112.0664.391
\$140



O2 Air Switch
WD3428ANT
112.0664.346
WD3428GLD
112.0664.347
\$55



O3 Strainer Basket
906-ANT
112.0630.003
906-GLD
112.0629.750
\$200

Culinary Center

Functional, beautiful organization.



Culinary Center is the perfect synthesis of cutting-edge technology and design, marrying classic and contemporary styles.

Packed with built-in features that put everyday tools at your fingertips as you work. Each element is organized according to a highly functional approach.



A place for everything

The double-bowl Culinary Center features essential accessories built right into the sleek design. When tasks are complete, everything stores neatly into this well-thought-out system.



Details matter

The custom-fitted accessories compartment allows you to dry and store the tools you use most, so they're ready when you need them, creating a functional organized kitchen workstation with everything in its place.

Designed for the way you work

The Culinary Center's two cutting boards, colander and draining rack are easily removed and positioned to fit the workflow that's most efficient for you. Rinsing, draining, chopping, dicing, and slicing are a snap when the right tools are at hand.



Culinary Center

MYTHOS



CUX11010-W

122.0571.176
\$2,535

Interior Dimensions: 10³/₈" x 18⁷/₈" x 8¹/₁₆"
Exterior Dimensions: 13³/₈" x 21³/₈"
Minimum Cabinet Size: 18"
Gauge: 19
Weight: 19 lbs.
Sound Dampening: Sound Pad
Stainless Finish: Diamond
Corner Radius: 12 mm
Installation: Undermount With 1/2" Reveal

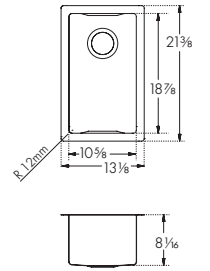

Accessories Included

A2	A3	A4	A5	A6	A7
A8	A9	A10	A12		

MYTHOS



CUX16021-W

122.0570.964
\$3,350

Interior Dimensions: 32¹/₁₆" x 18⁷/₈" x 9³/₁₆" & 8¹/₁₆"
Exterior Dimensions: 35³/₁₆" x 21³/₈"
Minimum Cabinet Size: 39"
Gauge: 19
Weight: 50 lbs.
Sound Dampening: Sound Pad
Stainless Finish: Diamond
Corner Radius: 12 mm
Installation: Undermount With 1/2" Reveal

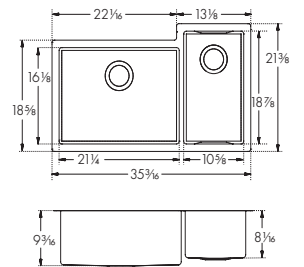

Accessories Included

A1	A2	A3	A4	A5	A6
A7	A8	A9	A10	A11	A12

ACCESSORIES INCLUDED



A1 Bottom Grid
20³/₁₆" x 15³/₈"
Stainless
CU21-36S
112.0388.963
\$200
Included



A2 Cutting Board
7¹/₁₆" x 16³/₈"
Walnut
CU-40S
112.0539.134
\$200
Included



A3 Cutting Board
7¹/₁₆" x 16³/₈"
Black Plastic
CU-40P
112.0539.120
\$135
Included



A4 Cutting Mat
11¹/₂" x 17³/₈"
Silicone
SP-40S
112.0342.598
\$90
Included



A5 Glass Cover/ Cutting Board
11¹/₂" x 19³/₈"
Black Glass
CU-GC
112.0570.963
\$160
Included



A6 Knife Holder + Cutting Board
7³/₁₆" x 16³/₈"
Walnut
CU-40K
112.0539.135
\$325
Included



A7 Knife Set
Set of 3
Black
CU-KS
112.0545.792
\$135
Included



A8 Colander
6⁷/₁₆" x 16³/₈" x 2¹/₂"
Stainless
CUW-70S
112.0394.981
\$265
Included



A9 Wire Rack
11" x 18³/₈"
Stainless
CU-WR
112.0539.138
\$175
Included



A10 Frame Cover
10¹/₂" x 18³/₈"
Stainless Finish
CU-FC
112.0548.292
\$270
Included



A11 Drain Cover
4¹/₂"
Stainless
RNDCVR
112.0532.169
\$120
One included
with CUX16021-W



A12 Strainer Basket
Chrome
1145
112.0055.508
\$80
Included

Workcenters

Creating a defined space in the kitchen.



A total kitchen solution

Franke Workcenters transform how you go about your daily meal prep and cleanup. They are functional and maximize efficiency while minimizing movement. A Workcenter sink offers multiple kitchen tools to wash food, chop, prep, clean up, dry dishes and more. It consolidates separate areas of your kitchen into one space.



Perfect workflow

Franke Workcenters support your entire food preparation by creating your own modular, innovative and design-oriented sink center.



Minimize chaos

The kitchen is the busiest place in your home. Franke Workcenter provides all the essentials needed for food prep or impromptu meals.

Limit cross-contamination

Kitchen sinks handle many tasks that might not be very sanitary. A Franke Workcenter can organize your sink to allow you to keep food prep items separated. It helps keep your food and kitchen more hygienic and reduces the chances of cross-contamination.



Fully equipped

Space-saving integrated tools offer plenty of room for prepping over the sink, freeing up counter space for other activities.



Peak



MYTHOS



Interior Dimensions: 27¹/₁₆" x 16¹/₂" x 9⁵/₈"
 Exterior Dimensions: 28³/₄" x 17³/₄"
 Minimum Cabinet Size: 33"
 Gauge: 16
 Weight: 41 lbs.
 Sound Dampening: Sound Pad
 Integral Franke Ledge System
 Stainless Finish: Diamond
 Corner Radius: 5 mm
 Installation: Undermount

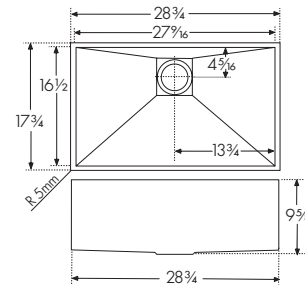

PKX11028-WKC
 122.0672.202
\$3,970

Accessories Included

A1 A2 A3 A4 A5

Accessories Optional

O1 O2

ACCESSORIES INCLUDED

- A1 Bottom/ Shelf Grid**
 27¹/₁₆" x 16¹/₄"
 Stainless
 PX-28S
 112.0173.263
\$280
 Included
- A2 Colander**
 6¹/₂" x 17¹/₁₆" x 2¹/₄"
 Stainless
 PX-70S
 112.0066.060
\$280
 Included
- A3 Cutting Board**
 14³/₈" x 17¹/₈"
 Solid Wood
 PX-40S
 112.0173.264
\$290
 Included
- A4 Strainer Basket**
 Chrome
 1145
 112.0055.508
\$80
 Included
- A5 Drain Cover**
 4⁷/₈" x 4⁷/₈"
 Stainless
 PKXCVR
 112.0169.254
\$135
 Included

ACCESSORIES OPTIONAL

- O1 Universal Roller Mat**
 18¹/₁₆" x 20"
 Stainless
 UV-36RM
 112.0391.220
\$225
 Optional
- O2 Inox Cream**
 Stainless
 Steel Polish
 903
 112.0039.150
\$50
 Optional
- Centinox**
 CEN-SP-304
 115.0547.857
\$955
 Optional

Professional



MYTHOS



Interior Dimensions: 33" x 17" x 10"
 Exterior Dimensions: 35¹/₂" x 19¹/₂"
 Minimum Cabinet Size: 39"
 Gauge: 16
 Weight: 44 lbs.
 Sound Dampening: Sound Pad & Spray Coat
 Stainless Finish: Diamond
 Corner Radius: 8 mm
 Installation: Undermount with 1/2" Reveal

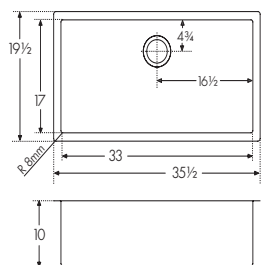

PS2X110-33-WKC
 122.0672.204
\$3,255

Accessories Included

A1 A2 A3 A4 A5

Accessories Optional

O1 O2

ACCESSORIES INCLUDED

- A1 Bottom Grid**
 32¹/₂" x 16¹/₂"
 Stainless
 PS2-33-36S
 112.0531.747
\$365
 Included
- A2 Cutting Board**
 11" x 17¹/₈" x 1"
 Maple
 PS2-45S
 112.0653.055
\$290
 Included
- A3 Colander**
 6¹/₂" x 17¹/₈" x 2¹/₄"
 Stainless
 PE-70S
 112.0334.171
\$290
 Included
- A4 Strainer Basket**
 Chrome
 1145
 112.0055.508
\$80
 Included
- A5 Drain Cover**
 4¹/₂"
 Stainless
 RNDCVR
 112.0532.169
\$120
 Included

ACCESSORIES OPTIONAL

- O1 Universal Roller Mat**
 18¹/₁₆" x 20"
 Stainless
 UV-36RM
 112.0391.220
\$225
 Optional
- O2 Inox Cream**
 Stainless
 Steel Polish
 903
 112.0039.150
\$50
 Optional
- Pescara**
 Stainless
 PES-SPX-304
 115.0435.802
\$1,175
 Optional

Pescara



MYTHOS

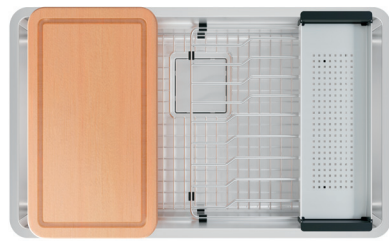

Interior Dimensions: 31" x 17" x 9½"
 Exterior Dimensions: 32½" x 18¼"
 Minimum Cabinet Size: 36"
 Gauge: 18
 Weight: 38 lbs.
 Sound Dampening: Sound Pad
 Stainless Finish: Silk
 Integral Franke Ledge System
 Corner Radius: 20 mm
 Installation: Undermount with 3 mm Reveal

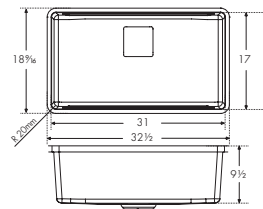

PTX110-31-WKC

122.0672.209
\$2,375

Accessories Included



Accessories Optional



ACCESSORIES INCLUDED

- A1 Bottom Grid**
29½" x 15½"
Stainless
PT31-36S
112.0491.340
\$240
Included
- A2 Shelf Grid**
14" x 16¼"
Stainless
PT14-31S
112.0490.011
\$190
Included
- A3 Cutting Board**
11" x 18½"
Solid Wood
PT-41S
112.0527.413
\$265
Included
- A4 Colander**
6¾" x 17¾" x 2½"
Stainless
PE-70S
112.0334.171
\$290
Included
- A5 Strainer Basket**
Chrome
1145
112.0055.508
\$80
Included
- A6 Drain Cover Stainless**
PKGCVR
112.0395.171
\$120
Included

ACCESSORIES OPTIONAL

- O1 Universal Roller Mat**
18¼" x 20"
Stainless
UV-36RM
112.0391.220
\$225
Optional
 - O2 Cutting Board**
10¾" x 18½"
Tempered Glass
PT-40S
112.0355.965
\$280
Optional
 - O3 Self-Healing Cutting Mat**
9¾" x 14¾"
Silicone
SP-40S
112.0342.598
\$90
Optional
 - O4 Inox Cream**
Stainless
Steel Polish
903
112.0039.150
\$50
Optional
- Pescara**
Stainless
PES-SP-304
115.0442.968
\$1,010
Optional

Orca 2.0



MARIS



Interior Dimensions: 29½" x 18¾" x 9¼"
 Exterior Dimensions: 30¾" x 20¼"
 Minimum Cabinet Size: 36"
 Gauge: 18
 Weight: 24 lbs.
 Sound Dampening: Sound Pad
 Stainless Finish: Silk
 Integral Franke Ledge System
 Corner Radius: 30 mm

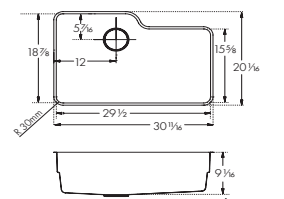

OR2X110-WKC

122.0672.203
\$2,155

Accessories Included



Accessories Optional



ACCESSORIES INCLUDED

- A1 Bottom Grid**
27¾" x 16¾"
Stainless
OC2-36S
112.0570.706
\$295
Included
- A2 Shelf Grid Roller Mat**
10½" x 15¾"
Stainless
OC2-31S-RH
112.0570.710
\$220
Included
- A3 Cutting Board**
17¾" x 19¾"
Solid Wood
with Stainless
Colander
OC2-45SP
112.0575.792
\$450
Included
- A4 Drain Cover**
4½"
Stainless
RNDCVR
112.0532.169
\$120
Included
- A5 Strainer Basket**
Chrome
1145
112.0055.508
\$80
Included
- A6 Wire Basket**
13¾" x 18½" x 2¾"
Stainless
OC2-50C
112.0570.708
\$220
Included

ACCESSORIES OPTIONAL

- O1 Inox Cream**
Stainless
Steel Polish
903
112.0039.150
\$50
Optional
- Steel**
Stainless
STL-PD-304
115.0355.504
\$875
Optional

Cube



MARIS



Interior Dimensions: 30" x 16 $\frac{1}{8}$ " x 9"
 Exterior Dimensions: 31 $\frac{1}{2}$ " x 17 $\frac{3}{4}$ "
 Minimum Cabinet Size: 36"
 Gauge: 18
 Weight: 21 lbs.
 Sound Dampening: Sound Pad & Spray Coat
 Stainless Finish: Pearl
 Corner Radius: 12 mm
 Installation: Undermount

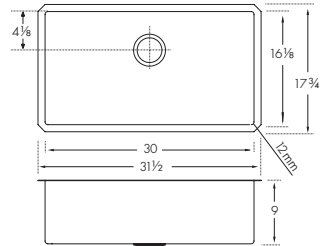

CUX11030-WKC

122.0672.231

\$1,875

Accessories Included

- A1
- A2
- A3
- A4
- A5
- A6
- A7
- A8
- A9
- A10

ACCESSORIES INCLUDED

- 

A1 Telescopic Bridge
7" expands to 24"
Stainless
Included
- 

A2 Large Bamboo Chopping Board
8" x 13"
Bamboo
Included
- 

A3 Large Colander
7" x 12" x 3 $\frac{3}{4}$ "
Sanitized® Polymer
Included
- 

A4 Small Colander
7" x 7" x 3 $\frac{3}{4}$ "
Sanitized® Polymer
Included
- 

A5 Small Bowl
7" x 7" x 3 $\frac{3}{4}$ "
Sanitized® Polymer
Included
- 

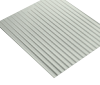
A6 Bamboo Bowl Lid
7" x 7"
Bamboo
Included
- 

A7 Silicone Mat
14" x 16"
Included
- 

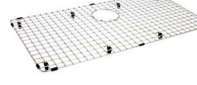
A8 Storage Container
11" x 21"
Polymer
Included
- 

A9 Bottom Grid
29 $\frac{1}{4}$ " x 15 $\frac{3}{8}$ "
Stainless
CU30-36S
112.0388.965
\$225
Included
- 

A10 Strainer Basket
Chrome
1145
112.0055.508
\$80
Included
- 

Eos Neo
Stainless
EOS-PD-304
115.0685.298
\$870
Optional



Peak

A passion for details.



Elegantly simple and exceedingly functional, the Peak sink collection exudes luxury. Clean lines and the 5 mm corner radius maximize bowl space. The square drain cover complements the minimalist design while obscuring the strainer basket.



More usable workspace

The removable drain cover conceals the drain for a seamless sink surface while providing a uniform bottom surface.

Premium materials

Made of 16-gauge stainless steel with a Diamond finish that will retain its beauty for many years.



Multi-level workspace

The bottom sink grid raises to sit on the integrated ledge, creating a higher level workspace to expand your prep, clean and rinse area.

Optimized performance

Seamless workflows, from prep to cook to clean. Unobstructed surfaces and smart layouts, optimized for preparing any meal.

Total kitchen solution

A complete kitchen solution, with a sink that makes sense and tools exactly where you need them, built for the way professionals work.



MYTHOS



PKX1108
112.0074.976
\$1,615

Interior Dimensions: 7¹/₈" x 16¹/₂" x 7¹/₈"
Exterior Dimensions: 8¹/₄" x 17³/₄"
Minimum Cabinet Size: 12"
Gauge: 18
Weight: 9 lbs.
Sound Dampening: Sound Pad
Stainless Finish: Diamond
Corner Radius: 5 mm
Installation: Undermount

Accessories Optional

O5 O7 O8 O9

Accessories Included

A1

Peak

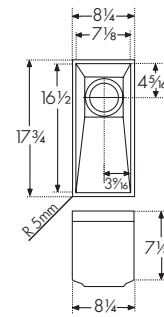

MYTHOS

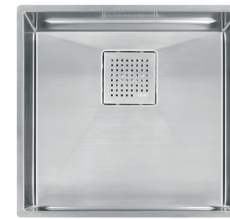

PKX11018
122.0074.938
\$3,065

Interior Dimensions: 17³/₄" x 16¹/₂" x 9⁵/₈"
Exterior Dimensions: 18⁷/₈" x 17³/₄"
Minimum Cabinet Size: 24"
Gauge: 16
Weight: 22 lbs.
Sound Dampening: Sound Pad
Stainless Finish: Diamond
Integral Franke Ledge System
Corner Radius: 5 mm
Installation: Undermount

Accessories Optional

O3 O5 O6 O7 O8 O9

Accessories Included

A1

Peak

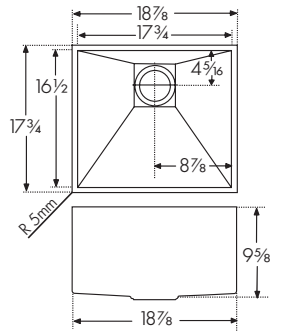

MYTHOS



PKX11013
122.0074.951
\$2,625

Interior Dimensions: 13³/₈" x 16¹/₂" x 9⁵/₈"
Exterior Dimensions: 14⁹/₁₆" x 17³/₄"
Minimum Cabinet Size: 18"
Gauge: 16
Weight: 19 lbs.
Sound Dampening: Sound Pad
Stainless Finish: Diamond
Integral Franke Ledge System
Corner Radius: 5 mm
Installation: Undermount

Accessories Optional

O1 O5 O7 O8 O9

Accessories Included

A1

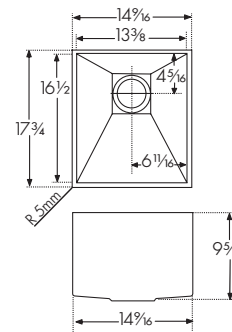

MYTHOS

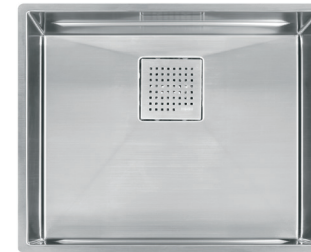

PKX11021
122.0074.956
\$3,265

Interior Dimensions: 21⁵/₈" x 16¹/₂" x 9⁵/₈"
Exterior Dimensions: 22¹³/₁₆" x 17³/₄"
Minimum Cabinet Size: 27"
Gauge: 16
Weight: 25 lbs.
Sound Dampening: Sound Pad
Stainless Finish: Diamond
Integral Franke Ledge System
Corner Radius: 5 mm
Installation: Undermount

Accessories Optional

O4 O5 O6 O7 O8 O9

Accessories Included

A1

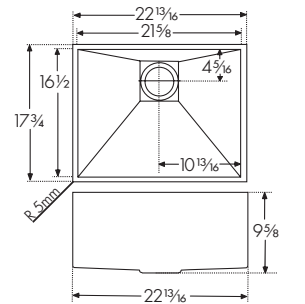

MYTHOS



PKX11016
122.0074.944
\$2,850

Interior Dimensions: 15³/₄" x 16¹/₂" x 9⁵/₈"
Exterior Dimensions: 16⁷/₈" x 17³/₄"
Minimum Cabinet Size: 21"
Gauge: 16
Weight: 21 lbs.
Sound Dampening: Sound Pad
Stainless Finish: Diamond
Integral Franke Ledge System
Corner Radius: 5 mm
Installation: Undermount

Accessories Optional







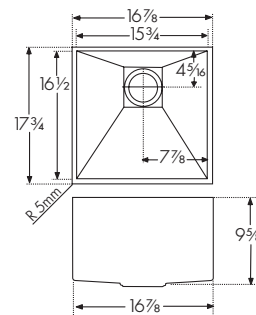

O2 O5 O6 O7 O8 O9

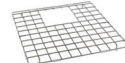
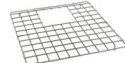
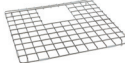
Accessories Included

A1

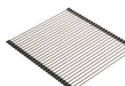

ACCESSORIES OPTIONAL

- | | | | | | |
|---|---|---|--|---|---|
| 
O1 Bottom/
Shelf Grid
13 ³ / ₈ " x 16 ¹ / ₄ "
Stainless
PX-13S
112.0173.258
\$190 | 
O2 Bottom/
Shelf Grid
15 ¹ / ₂ " x 16 ¹ / ₄ "
Stainless
PX-16S
112.0173.260
\$200 | 
O3 Bottom/
Shelf Grid
17 ¹ / ₂ " x 16 ¹ / ₄ "
Stainless
PX-18S
112.0173.261
\$210 | 
O4 Bottom/Shelf
Grid
21 ¹ / ₈ " x 16 ¹ / ₄ "
Stainless
PX-21S
112.0173.262
\$250 | 
O5 Colander
6 ¹ / ₄ " x 17 ³ / ₁₆ " x 2 ¹ / ₈ "
Stainless
PX-70S
112.0066.060
\$280 | 
O6 Cutting
Board
14 ³ / ₈ " x 17 ¹ / ₈ "
Solid Wood
PX-40S
112.0173.264
\$290 |
| 
O7 Strainer
Basket
Chrome
1145
112.0055.508
\$80
Satin Nickel
1145SN
112.0185.195
\$115 | 
O8 Universal
Roller Mat
18 ¹ / ₄ " x 20"
Stainless
UV-36RM
112.0391.220
\$225 | 
O9 Inox Cream
Stainless
Steel Polish
903
112.0039.150
\$50 | 
A1 Drain Cover
4 ¹ / ₈ " x 4 ¹ / ₈ "
Stainless
PKXCVR
112.0169.254
\$135
One included
with each sink | 
Centinox
CEN-SP-304
115.0547.857
\$955 | |

MYTHOS

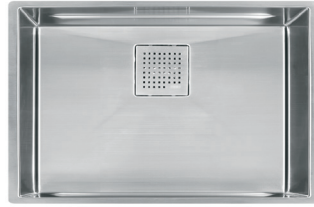

PKX11025
122.0192.590
\$3,420

Interior Dimensions: 25" x 16½" x 9⅝"
Exterior Dimensions: 26⅜" x 17¾"
Minimum Cabinet Size: 30"
Gauge: 16
Weight: 27 lbs.
Sound Dampening: Sound Pad
Integral Franke Ledge System
Stainless Finish: Diamond
Corner Radius: 5 mm
Installation: Undermount

Accessories Optional

O2 O4 O5 O6 O7 O8

Accessories Included

A1

Peak

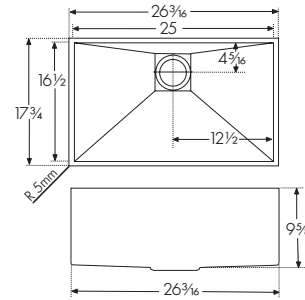

ACCESSORIES OPTIONAL



O1 Bottom/Shelf Grid
21⅝" x 16¼"
Stainless
PX-21S
112.0173.262
\$250

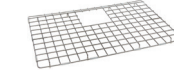

O2 Bottom/Shelf Grid
24¼" x 16¼"
Stainless
PX-25S
112.0260.338
\$265



O3 Bottom/Shelf Grid
27⅞" x 16¼"
Stainless
PX-28S
112.0173.263
\$280



O4 Colander
6⅞" x 17⅞" x 2⅝"
Stainless
PX-70S
112.0066.060
\$280



O5 Cutting Board
14⅞" x 17⅞"
Solid Wood
PX-40S
112.0173.264
\$290



O6 Strainer Basket
Chrome
1145
112.0055.508
\$80
Satin Nickel
1145SN
112.0185.195
\$115

MYTHOS

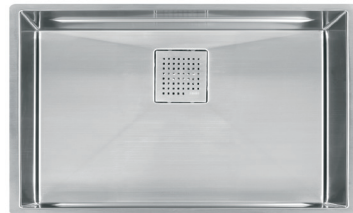

PKX11028
122.0074.954
\$3,555

Interior Dimensions: 27⅞" x 16½" x 9⅝"
Exterior Dimensions: 28¾" x 17¾"
Minimum Cabinet Size: 33"
Gauge: 16
Weight: 29 lbs.
Sound Dampening: Sound Pad
Integral Franke Ledge System
Stainless Finish: Diamond
Corner Radius: 5 mm
Installation: Undermount

Accessories Optional

O3 O4 O5 O6 O7 O8

Accessories Included

A1

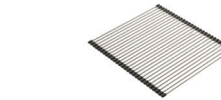
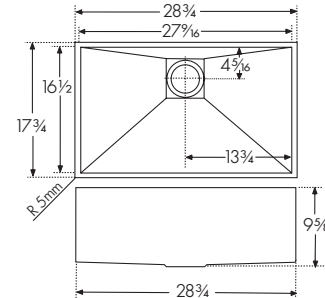

O7 Universal Roller Mat
18 7/8" x 20"
Stainless
UV-36RM
112.0391.220
\$225



O8 Inox Cream
Stainless
Steel Polish
903
112.0039.150
\$50



A1 Drain Cover
4⅞" x 4⅞"
Stainless
PKXCVR
112.0169.254
\$135
One included with each sink. PKX160 & PKX160LH include two.



Centinox
CEN-SP-304
115.0547.857
\$955

MYTHOS

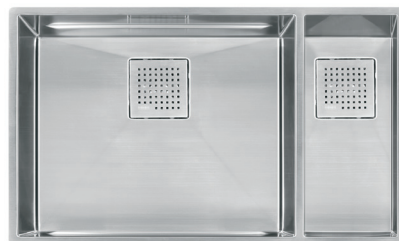

PKX160
122.0080.011
\$4,080

PKX160LH
122.0074.965
\$4,080

Interior Dimensions: 29¾" x 16½" x 9⅝" & 7⅞"
Exterior Dimensions: 30⅞" x 17¾"
Minimum Cabinet Size: 36"
Gauge: 16
Weight: 35 lbs.
Sound Dampening: Sound Pad
Stainless Finish: Diamond
Integral Franke Ledge System: Large Bowl
Corner Radius: 5 mm
Installation: Undermount

Accessories Optional

O1 O4 O5 O6 O7 O8

Accessories Included

A1

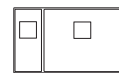
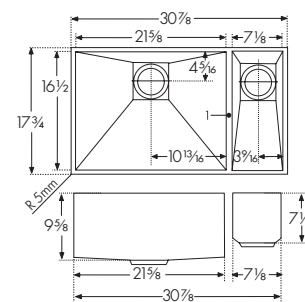

Left-Hand Sink
PKX160LH

Note: All accessories sold separately unless otherwise indicated. Design of custom accessories subject to change without notice. It is absolutely critical that you have the sink and any custom sink accessories on-site prior to any cut or modification to the countertop. Franke will not be responsible for any errors in countertop preparation and sink installation.

Peak



PKX11028-WKC

122.0672.202

\$3,970

Interior Dimensions: 27¹/₁₆" x 16¹/₂" x 9⁵/₈"
 Exterior Dimensions: 28³/₄" x 17³/₄"
 Minimum Cabinet Size: 33"
 Gauge: 16
 Weight: 41 lbs.
 Sound Dampening: Sound Pad
 Integral Franke Ledge System
 Stainless Finish: Diamond
 Corner Radius: 5 mm
 Installation: Undermount

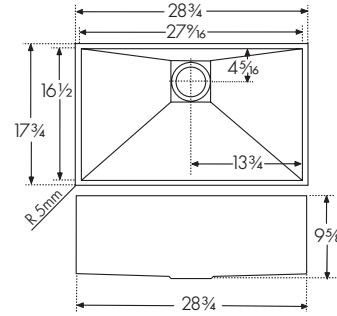

Accessories Included

- A1
- A2
- A3
- A4
- A5

Accessories Optional

- O1
- O2

ACCESSORIES INCLUDED



**A1 Bottom/
Shelf Grid**
 27¹/₁₆" x 16¹/₂"
 Stainless
 PX-28S
 112.0173.263
\$280
 Included



A2 Colander
 6¹/₂" x 17¹/₁₆" x 2¹/₁₆"
 Stainless
 PX-70S
 112.0066.060
\$280
 Included



A3 Cutting Board
 14¹/₂" x 17¹/₁₆"
 Solid Wood
 PX-40S
 112.0173.264
\$290
 Included



**A4 Strainer
Basket**
 Chrome
 1145
 112.0055.508
\$80
 Included



A5 Drain Cover
 4⁷/₈" x 4⁷/₈"
 Stainless
 PKXCVR
 112.0169.254
\$135
 Included

ACCESSORIES OPTIONAL

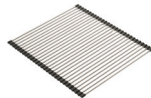

**O1 Universal
Roller Mat**
 18¹/₂" x 20"
 Stainless
 UV-36RM
 112.0391.220
\$225
 Optional



**O2 Inox Cream
Steel Polish**
 903
 112.0039.150
\$50
 Optional



Centinox
 CEN-SP-304
 115.0547.857
\$955
 Optional



Professional

Luxury at its best.



The Professional is an engineering masterpiece and raises the bar for premium sinks. This kitchen sink features an integrated accessory ledge that allows accessories to glide over the sink and a concealed drain that stops stemware from falling over.

It also boasts sleek, sculptural lines made of 16-gauge commercial stainless steel with a Diamond finish that highlights the sink's beauty.



Integrated accessory ledge

Allows accessories to work within the sink, creating a seamless workflow to make food prep a pleasure.



Rear drain cover

The removable drain cover conceals the drain for a seamless sink surface, while the rear placement provides extra cabinet space beneath the sink.

Deep capacity sink

A large deep sink makes it easy-to-clean large cookware items and minimizes splashing, offering the form and function you expect from your sink.



Professional

MYTHOS



PS2X110-15
122.0530.829
\$1,920

Interior Dimensions: 15" x 17" x 8"
Exterior Dimensions: 17½" x 19½"
Minimum Cabinet Size: 21"
Gauge: 16
Weight: 21 lbs.
Sound Dampening: Sound Pad & Spray Coat
Stainless Finish: Diamond
Corner Radius: 8 mm
Installation: Undermount with ½" Reveal

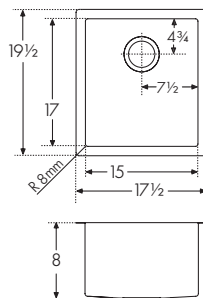

Accessories Optional

O1 O5 O6 O7 O8 O9

Accessories Included

A1

MYTHOS



PS2X110-18
122.0530.830
\$1,985

Interior Dimensions: 18" x 17" x 10"
Exterior Dimensions: 20½" x 19½"
Minimum Cabinet Size: 24"
Gauge: 16
Weight: 23 lbs.
Sound Dampening: Sound Pad & Spray Coat
Stainless Finish: Diamond
Corner Radius: 8 mm
Installation: Undermount with ½" Reveal

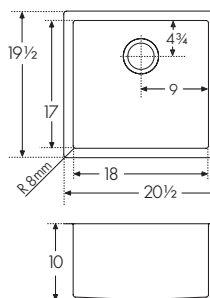

Accessories Optional

O2 O5 O6 O7 O8 O9

Accessories Included

A1

MYTHOS



PS2X110-21
122.0530.923
\$2,060

Interior Dimensions: 21" x 17" x 10"
Exterior Dimensions: 23½" x 19½"
Minimum Cabinet Size: 27"
Gauge: 16
Weight: 25 lbs.
Sound Dampening: Sound Pad & Spray Coat
Stainless Finish: Diamond
Corner Radius: 8 mm
Installation: Undermount with ½" Reveal

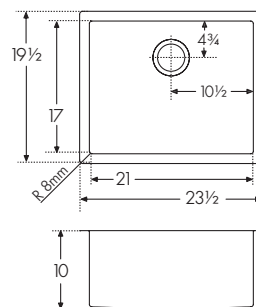

Accessories Optional

O3 O5 O6 O7 O8 O9

Accessories Included

A1

Professional

MYTHOS



PS2X110-24
122.0530.924
\$2,135

Interior Dimensions: 24" x 17" x 10"
Exterior Dimensions: 26½" x 19½"
Minimum Cabinet Size: 30"
Gauge: 16
Weight: 27 lbs.
Sound Dampening: Sound Pad & Spray Coat
Stainless Finish: Diamond
Corner Radius: 8 mm
Installation: Undermount with ½" Reveal

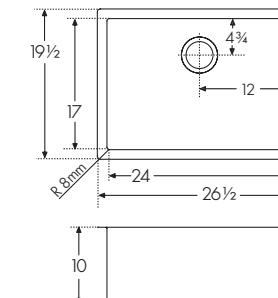

Accessories Optional

O4 O5 O6 O7 O8 O9

Accessories Included

A1

MYTHOS



PS2X110-24-12
122.0530.925
\$2,195

Interior Dimensions: 24" x 17" x 12"
Exterior Dimensions: 26½" x 19½"
Minimum Cabinet Size: 30"
Gauge: 16
Weight: 29 lbs.
Sound Dampening: Sound Pad & Spray Coat
Stainless Finish: Diamond
Corner Radius: 8 mm
Installation: Undermount with ½" Reveal

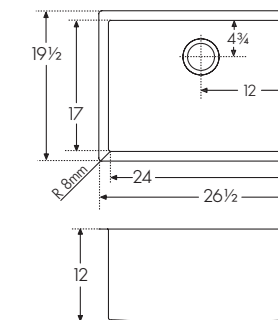

Accessories Optional

O4 O5 O6 O7 O8 O9

Accessories Included

A1



Suitable for laundry/utility

ACCESSORIES OPTIONAL



O1 Bottom Grid
14½" x 16½"
Stainless
PS2-15-36S
112.0531.739
\$190

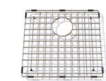

O2 Bottom Grid
17½" x 16½"
Stainless
PS2-18-36S
112.0531.741
\$210



O3 Bottom Grid
20½" x 16½"
Stainless
PS2-21-36S
112.0531.743
\$250

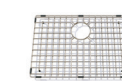

O4 Bottom Grid
23½" x 16½"
Stainless
PS2-24-36S
112.0531.744
\$265



O5 Cutting Board
11" x 17½" x 1"
Maple
PS2-45S
112.0653.055
\$290



O6 Colander
6⅝" x 17⅞" x 2½"
Stainless
PE-70S
112.0334.171
\$290



O7 Strainer Basket
Chrome
1145
112.0055.508
\$80
Satin Nickel
1145SN
112.0185.195
\$115



O8 Roller Mat
12⅞" x 17½"
Stainless
RM18S
112.0545.618
\$210



O9 Inox Cream
Stainless
Steel Polish
903
112.0039.150
\$50



A1 Drain Cover
4½"
Stainless
RNDCVR
112.0532.169
\$120
One included with each sink.



Icon
Chrome
ICN-PO-CHR
115.0690.303
\$1,050

MYTHOS

Professional



Interior Dimensions: 27" x 17" x 10"
 Exterior Dimensions: 29½" x 19½"
 Minimum Cabinet Size: 33"
 Gauge: 16
 Weight: 29 lbs.
 Sound Dampening: Sound Pad & Spray Coat
 Stainless Finish: Diamond
 Corner Radius: 8 mm
 Installation: Undermount with ½" Reveal

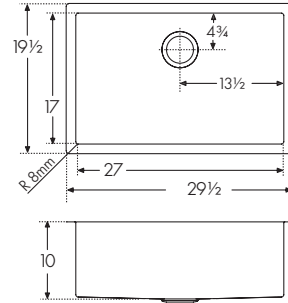

PS2X110-27
 122.0530.926
\$2,275

Accessories Optional
O1 O4 O5 O6 O7 O8
 Accessories Included
A1

MYTHOS

Professional

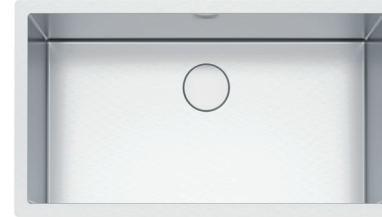

Interior Dimensions: 33" x 17" x 10"
 Exterior Dimensions: 35½" x 19½"
 Minimum Cabinet Size: 39"
 Gauge: 16
 Weight: 33 lbs.
 Sound Dampening: Sound Pad & Spray Coat
 Stainless Finish: Diamond
 Corner Radius: 8 mm
 Installation: Undermount with ½" Reveal

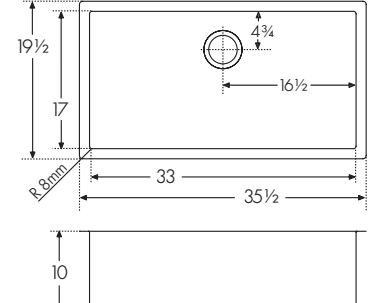

PS2X110-33
 122.0530.941
\$2,745

Accessories Optional
O3 O4 O5 O6 O7 O8
 Accessories Included
A1

MYTHOS





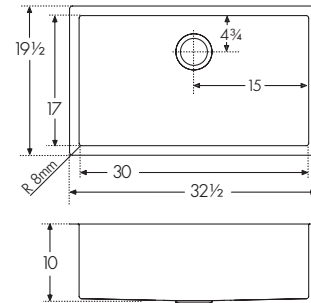





Interior Dimensions: 30" x 17" x 10"
 Exterior Dimensions: 32½" x 19½"
 Minimum Cabinet Size: 36"
 Gauge: 16
 Weight: 31 lbs.
 Sound Dampening: Sound Pad & Spray Coat
 Stainless Finish: Diamond
 Corner Radius: 8 mm
 Installation: Undermount with ½" Reveal

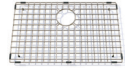
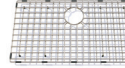
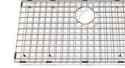

PS2X110-30
 122.0530.928
\$2,410

Accessories Optional
O2 O4 O5 O6 O7 O8
 Accessories Included
A1

ACCESSORIES OPTIONAL

- | | | | | | |
|--|--|--|---|--|---|
| 
O1 Bottom Grid
26½" x 16½"
Stainless
PS2-27-36S
112.0531.745
\$290 | 
O2 Bottom Grid
29½" x 16½"
Stainless
PS2-30-36S
112.0531.746
\$340 | 
O3 Bottom Grid
32½" x 16½"
Stainless
PS2-33-36S
112.0531.747
\$365 | 
O4 Cutting Board
11" x 17¼" x 1"
Maple
PS2-45S
112.0653.055
\$290 | 
O5 Colander
6½" x 17½" x 2½"
Stainless
PE-70S
112.0334.171
\$290 | 
O6 Strainer Basket
Chrome
1145
112.0055.508
\$80
Satin Nickel
1145SN
112.0185.195
\$115 |
| 
O7 Roller Mat
12¹⁹⁄₁₆" x 17⁷⁄₈"
Stainless
RM18S
112.0545.618
\$210 | 
O8 Inox Cream
Stainless
Steel Polish
903
112.0039.150
\$50 | 
A1 Drain Cover
4½"
Stainless
RNDCVR
112.0532.169
\$120
One included with each sink. | 
Icon
Chrome
ICN-PO-CHR
115.0690.303
\$1,050 | | |

MYTHOS



Interior Dimensions: 30" x 17" x 12"
 Exterior Dimensions: 32½" x 19½"
 Minimum Cabinet Size: 36"
 Gauge: 16
 Weight: 32 lbs.
 Sound Dampening: Sound Pad & Spray Coat
 Stainless Finish: Diamond
 Corner Radius: 8 mm
 Installation: Undermount with ½" Reveal

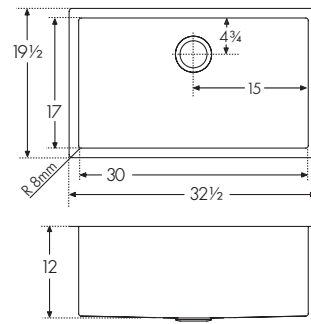

PS2X110-30-12
 122.0530.930
\$2,550

Accessories Optional
O2 O4 O5 O6 O7 O8
 Accessories Included
A1

 Suitable for laundry/utility

Note: All accessories sold separately unless otherwise indicated. Design of custom accessories subject to change without notice. It is absolutely critical that you have the sink and any custom sink accessories on-site prior to any cut or modification to the countertop. Franke will not be responsible for any errors in countertop preparation and sink installation.

Professional

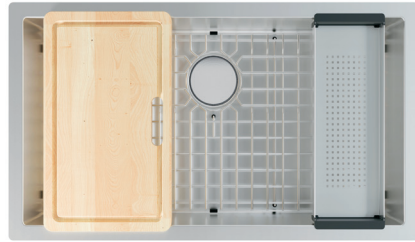

Interior Dimensions: 33" x 17" x 10"
 Exterior Dimensions: 35½" x 19½"
 Minimum Cabinet Size: 39"
 Gauge: 16
 Weight: 44 lbs.
 Sound Dampening: Sound Pad & Spray Coat
 Stainless Finish: Diamond
 Corner Radius: 8 mm
 Installation: Undermount with ½" Reveal

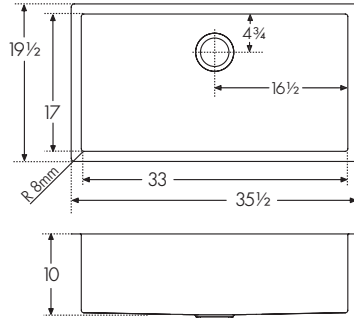

PS2X110-33-WKC

122.0672.204

\$3,255

Accessories Included

- A1
- A2
- A3
- A4
- A5

Accessories Optional

- O1
- O2

ACCESSORIES INCLUDED

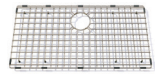

A1 Bottom Grid
 32½" x 16½"
 Stainless
 PS2-33-36S
 112.0531.747
\$365
 Included



A2 Cutting Board
 11" x 17½" x 1"
 Maple
 PS2-45S
 112.0653.055
\$290
 Included



A3 Colander
 6⅝" x 17⅝" x 2⅝"
 Stainless
 PE-70S
 112.0334.171
\$290
 Included



A4 Strainer Basket
 Chrome
 1145
 112.0055.508
\$80
 Included



A5 Drain Cover
 4½"
 Stainless
 RNDCVR
 112.0532.169
\$120
 Included

ACCESSORIES OPTIONAL



O1 Roller Mat
 12⅓¼" x 17⅞"
 Stainless
 RM18S
 112.0545.618
\$210
 Optional



O2 Inox Cream
 Stainless
 Steel Polish
 903
 112.0039.150
\$50
 Optional



Steel
 Stainless Steel
 STL-PD-304
 115.0355.504
\$875
 Optional



Universal
 Stainless
 UNJ-FW-304
 120.0704.764
\$625
 Optional



Professional



PS2X160-18-11
122.0530.942
\$2,880

Interior Dimensions: 30" x 17" x 10" & 9"
Exterior Dimensions: 32½" x 19½"
Minimum Cabinet Size: 36"
Gauge: 16
Weight: 34 lbs.
Sound Dampening: Sound Pad & Spray Coat
Stainless Finish: Diamond
Corner Radius: 8 mm
Installation: Undermount with ½" Reveal

Accessories Optional

- O1
- O2
- O5
- O6
- O7
- O8
- O9

Accessories Included

- A1

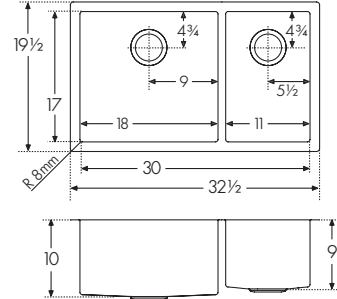

PS2X120-14-14
122.0530.932
\$2,880

Interior Dimensions: 29" x 17" x 10"
Exterior Dimensions: 31½" x 19½"
Minimum Cabinet Size: 36"
Gauge: 16
Weight: 32 lbs.
Sound Dampening: Sound Pad & Spray Coat
Stainless Finish: Diamond
Corner Radius: 8 mm
Installation: Undermount with ½" Reveal

Accessories Optional

- O3
- O5
- O6
- O7
- O8
- O9

Accessories Included

- A1

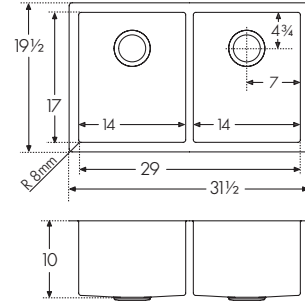

PS2X120-16-16
122.0530.933
\$3,015

Interior Dimensions: 33" x 17" x 10"
Exterior Dimensions: 35½" x 19½"
Minimum Cabinet Size: 39"
Gauge: 16
Weight: 38 lbs.
Sound Dampening: Sound Pad & Spray Coat
Stainless Finish: Diamond
Corner Radius: 8 mm
Installation: Undermount with ½" Reveal

Accessories Optional







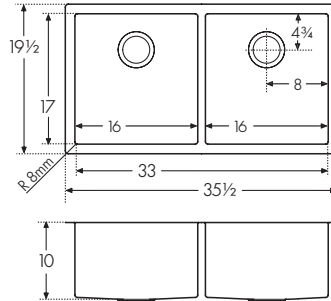



- O4
- O5
- O6
- O7
- O8
- O9

Accessories Included

- A1



ACCESSORIES OPTIONAL

- | | | | | | |
|---|--|--|--|---|--|
| 
O1 Bottom Grid
10½" x 16½"
Stainless
PS2-11-36S
112.0531.737
\$170 | 
O2 Bottom Grid
17½" x 16½"
Stainless
PS2-18-36S
112.0531.741
\$210 | 
O3 Bottom Grid
13½" x 16½"
Stainless
PS2-14-36S
112.0531.738
\$180 | 
O4 Bottom Grid
15½" x 16½"
Stainless
PS2-16-36S
112.0531.740
\$200 | 
O5 Cutting Board
11" x 17½" x 1"
Maple
PS2-45S
112.0653.055
\$290 | 
O6 Colander
6½" x 17½" x 2½"
Stainless
PE-70S
112.0334.171
\$290 |
| 
O7 Strainer Basket
Chrome
1145
112.0055.508
\$80
Satin Nickel
1145SN
112.0185.195
\$115 | 
O8 Roller Mat
12¾" x 17¾"
Stainless
RM18S
112.0545.618
\$210 | 
O9 Inox Cream
Stainless
Steel Polish
903
112.0039.150
\$50 | 
A1 Drain Cover
4½"
Stainless
RNDCVR
112.0532.169
\$120
Two included with each double bowl sink. | 
Icon
Chrome
ICN-PO-CHR
115.0690.303
\$1,050 | |

Crystal

Style and timeless simplicity.



Perfect symmetry

An exclusive combination of stainless steel and glass crafted to meet the most demanding standards in modern aesthetics. Each element is highly functional and beautifully shaped to add elegance and character to your kitchen.

Concealed drain cover

Not only beautiful but also extremely functional. More versatile thanks to its concealed drain cover which provides more usable space in the sink.

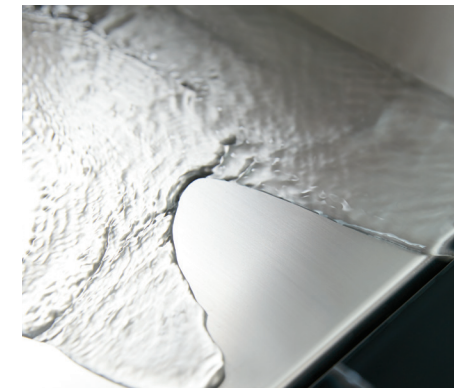

Commercial-grade stainless steel

Made of 16-gauge stainless steel with a Diamond finish that will retain its beauty for many years.

Reversible installation

An invisible drain is located on the side of the sink bowl and can be installed with either a left or right side drain hole (single bowl sinks only), allowing for more room beneath the sink.



MYTHOS



CLV110-24
122.0531.749
\$2,015

Interior Dimensions: 24½" x 17" x 9"
Exterior Dimensions: 26½" x 19"
Minimum Cabinet Size: 30"
Gauge: 16
Weight: 28 lbs.
Sound Dampening: Sound Pad & Spray Coat
Stainless Finish: Diamond
Corner Radius: 0 mm
Installation: Undermount with ½" Reveal

Accessories Optional

O2 O5 O6 O7 O8

Accessories Included

A1

Crystal

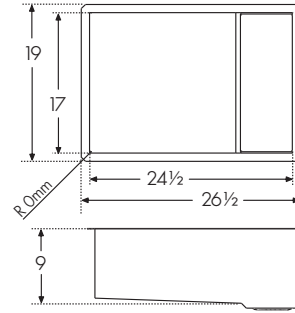

MYTHOS



CLV120-33
122.0531.785
\$2,410

Interior Dimensions: 30" x 17" x 9"
Exterior Dimensions: 32½" x 19"
Minimum Cabinet Size: 36"
Gauge: 16
Weight: 35 lbs.
Sound Dampening: Sound Pad & Spray Coat
Stainless Finish: Diamond
Corner Radius: 0 mm
Installation: Undermount with ½" Reveal

Accessories Optional

O1 O5 O6 O7 O8

Accessories Included

A1

Crystal

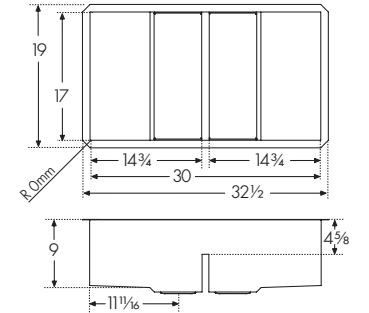

MYTHOS



CLV110-28
122.0531.769
\$2,155

Interior Dimensions: 27½" x 17" x 9"
Exterior Dimensions: 29½" x 19"
Minimum Cabinet Size: 33"
Gauge: 16
Weight: 31 lbs.
Sound Dampening: Sound Pad & Spray Coat
Stainless Finish: Diamond
Corner Radius: 0 mm
Installation: Undermount with ½" Reveal

Accessories Optional

O3 O5 O6 O7 O8

Accessories Included

A1

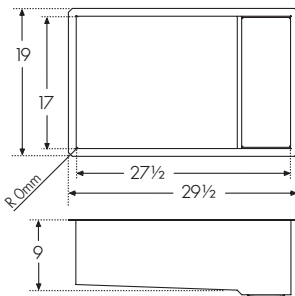

ACCESSORIES OPTIONAL



O1 Bottom Grid
15" x 16¾" x 4¾"
Stainless
CL-14-36S
112.0545.903
\$210



O2 Bottom Grid
16½" x 16½"
Stainless
CL-24-36S
112.0532.790
\$210



O3 Bottom Grid
19½" x 16½"
Stainless
CL-28-36S
112.0532.782
\$225



O4 Bottom Grid
22¾" x 16½"
Stainless
CL-31-36S
112.0532.290
\$240



O5 Cutting Board
11" x 17½" x 1"
Maple
PS2-45S
112.0653.055
\$290



O6 Colander
6½" x 17½" x 2½"
Stainless
PE-70S
112.0334.171
\$290



O7 Roller Mat
12¾" x 17¾"
Stainless
RM18S
112.0545.618
\$210



O8 Strainer Basket
Chrome
1145
112.0055.508
\$80
Satin Nickel
1145SN
112.0185.195
\$115

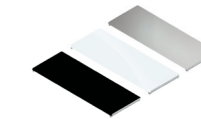

A1 Drain Cover
6¼" x 16½"
Black
CL-BGC
112.0533.213
\$190
Included
White
CL-WGC
112.0533.212
\$190
Optional
Stainless Steel
CL-SSC
112.0533.214
\$160
Optional



Icon Semi-Pro
Matte Black
ICN-SP-MBK
115.0690.402
\$1,575

MYTHOS

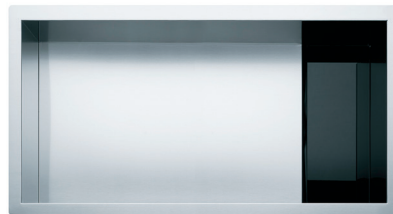

CLV110-31
122.0531.781
\$2,280

Interior Dimensions: 30½" x 17" x 9"
Exterior Dimensions: 32½" x 19"
Minimum Cabinet Size: 36"
Gauge: 16
Weight: 34 lbs.
Sound Dampening: Sound Pad & Spray Coat
Stainless Finish: Diamond
Corner Radius: 0 mm
Installation: Undermount with ½" Reveal

Accessories Optional

O4 O5 O6 O7 O8

Accessories Included

A1

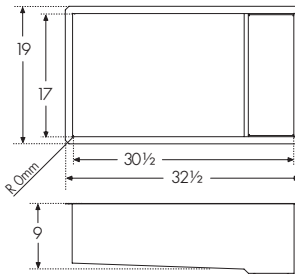

Note: All accessories sold separately unless otherwise indicated. Design of custom accessories subject to change without notice. It is absolutely critical that you have the sink and any custom sink accessories on-site prior to any cut or modification to the countertop. Franke will not be responsible for any errors in countertop preparation and sink installation.

Pescara

The perfect family sink.



The Pescara collection has it all. Featuring an integrated accessory ledge that allows food prep to happen over the sink, the Pescara collection has been finished with a Pearl finish, providing a lustrous sheen. Functional as a food preparation and cleaning station and to prepare meals for family and friends.



Fully equipped workcenter

Create a workspace that is as beautiful as it is functional. Our space-saving integrated kitchen tools offer plenty of room for prepping over your sink, freeing up counter space for other cooking activities.

Multi-level workspace

The shelf grid sits conveniently on the integrated ledge system, creating a higher-level workspace. Expand your workspace when you prep, rinse and clean.



Concealed drain cover

The removable drain cover conceals the drain for a seamless sink surface, while providing a uniform bottom surface to allow for more usable workspace.

Sound dampening system

The sound dampening pads reduce excess noise from running water and disposal vibration.

MYTHOS



PTX110-14
122.0491.561
\$830

Interior Dimensions: 13½" x 17" x 8"
Exterior Dimensions: 14⅞" x 18⅜"
Minimum Cabinet Size: 18"
Gauge: 18
Weight: 11 lbs.
Sound Dampening: Sound Pad
Stainless Finish: Pearl
Corner Radius: 20 mm
Installation: Undermount with 3 mm Reveal

Accessories Optional
O1 O7 O8 O9 O10 O11 O12
Accessories Included
A1

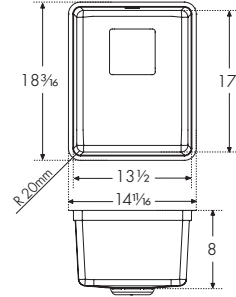

Pescara

MYTHOS

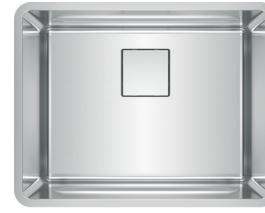

PTX110-22
122.0491.564
\$1,340

Interior Dimensions: 22⅞" x 17" x 9½"
Exterior Dimensions: 23⅝" x 18½"
Minimum Cabinet Size: 27"
Gauge: 18
Weight: 18 lbs.
Sound Dampening: Sound Pad
Stainless Finish: Pearl
Integral Franke Ledge System
Corner Radius: 20 mm
Installation: Undermount with 3 mm Reveal

Accessories Optional
O4 O6 O7 O8 O9 O10 O11 O12
Accessories Included
A1

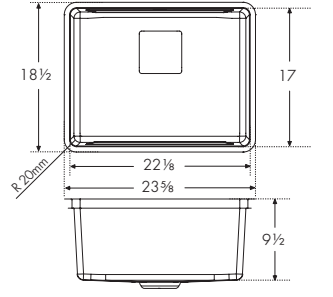

MYTHOS



PTX110-17
122.0491.562
\$925

Interior Dimensions: 16⅞" x 17" x 8½"
Exterior Dimensions: 17¾" x 18⅜"
Minimum Cabinet Size: 21"
Gauge: 18
Weight: 14 lbs.
Sound Dampening: Sound Pad
Stainless Finish: Pearl
Integral Franke Ledge System
Corner Radius: 20 mm
Installation: Undermount with 3mm Reveal

Accessories Optional
O2 O6 O7 O8 O9 O10 O11 O12
Accessories Included
A1

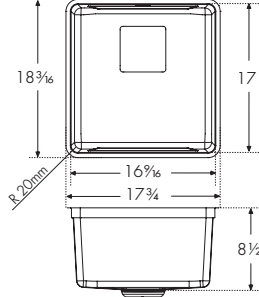

MYTHOS

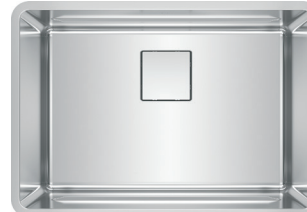

PTX110-25
122.0491.565
\$1,410

Interior Dimensions: 25" x 17" x 9½"
Exterior Dimensions: 26½" x 18½"
Minimum Cabinet Size: 30"
Gauge: 18
Weight: 20 lbs.
Sound Dampening: Sound Pad
Stainless Finish: Pearl
Integral Franke Ledge System
Corner Radius: 20 mm
Installation: Undermount with 3 mm Reveal

Accessories Optional
O5 O6 O7 O8 O9 O10 O11 O12
Accessories Included
A1

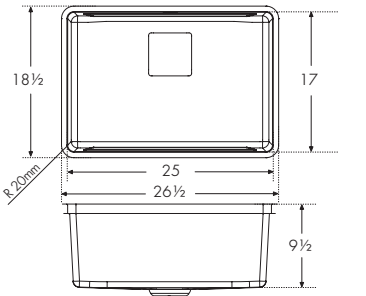

MYTHOS

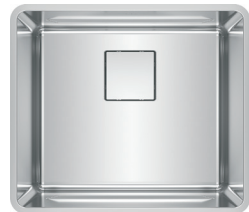







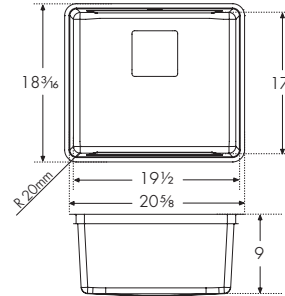



PTX110-20
122.0491.563
\$1,205

Interior Dimensions: 19½" x 17" x 9"
Exterior Dimensions: 20⅝" x 18⅜"
Minimum Cabinet Size: 24"
Gauge: 18
Weight: 16 lbs.
Sound Dampening: Sound Pad
Stainless Finish: Pearl
Integral Franke Ledge System
Corner Radius: 20 mm
Installation: Undermount with 3 mm Reveal

Accessories Optional
O3 O6 O7 O8 O9 O10 O11 O12
Accessories Included
A1

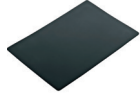

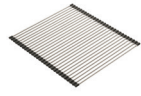
ACCESSORIES OPTIONAL

- | | | | | | | |
|--|--|---|--|--|---|---|
| 
O1 Bottom Grid
12⅞" x 15⅞"
Stainless
PT14-36S
112.0491.334
\$190 | 
O2 Bottom Grid
15" x 15⅞"
Stainless
PT17-36S
112.0491.401
\$200 | 
O3 Bottom Grid
18⅞" x 15⅞"
Stainless
PT20-36S
112.0489.171
\$205 | 
O4 Bottom Grid
20⅞" x 15⅞"
Stainless
PT22-36S
112.0491.337
\$210 | 
O5 Bottom Grid
23⅞" x 15⅞"
Stainless
PT25-36S
112.0491.338
\$220 | 
O6 Shelf Grid
14" x 16¼"
Stainless
PT14-31S
112.0490.011
\$190 | 
O7 Cutting Board
10½" x 18½"
Tempered Glass
PT-40S
112.0355.965
\$280 |
| 
O8 Self-Healing Cutting Mat
9⅞" x 14⅞"
Silicone
SP-40S
112.0342.598
\$90 | 
O9 Cutting Board
11" x 18½"
Solid Wood
PT-41S
112.0527.413
\$265 | 
O10 Colander
6⅞" x 17⅞" x 2¼"
Stainless
PE-70S
112.0334.171
\$290 | 
O11 Universal Roller Mat
18⅞" x 20"
Stainless
UV-36RM
112.0391.220
\$225 | 
O12 Strainer Basket
Chrome
1145
112.0055.508
\$80
Satin Nickel
1145SN
112.0185.195
\$115 | 
A1 Drain Cover
Stainless
PKGCVR
112.0395.171
\$120
One included with each bowl. | |

MYTHOS

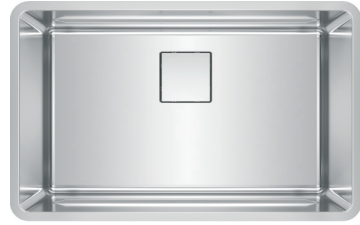

PTX110-28
122.0491.566
\$1,505

Interior Dimensions: 28" x 17" x 9½"
Exterior Dimensions: 29½" x 18¾"
Minimum Cabinet Size: 33"
Gauge: 18
Weight: 21 lbs.
Sound Dampening: Sound Pad
Stainless Finish: Pearl
Integral Franke Ledge System
Corner Radius: 20 mm
Installation: Undermount with 3 mm Reveal

Accessories Optional

- O1
- O3
- O4
- O5
- O6
- O7
- O8
- O9
- O10

Accessories Included

- A1

Pescara

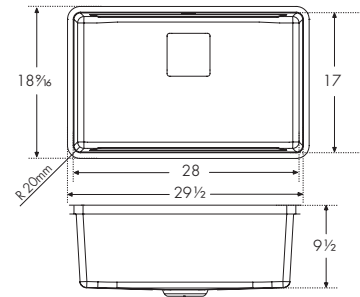

MYTHOS

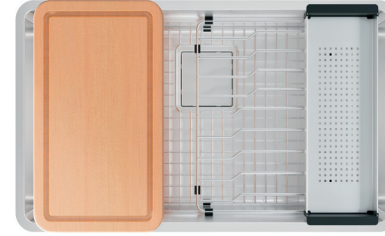

PTX110-31-WKC
122.0672.209
\$2,375

Interior Dimensions: 31" x 17" x 9½"
Exterior Dimensions: 32½" x 18¾"
Minimum Cabinet Size: 36"
Gauge: 18
Weight: 38 lbs.
Sound Dampening: Sound Pad
Stainless Finish: Silk
Integral Franke Ledge System
Corner Radius: 20 mm
Installation: Undermount with 3 mm Reveal

Accessories Optional

- O1
- O2
- O3
- O4

Accessories Included

- A1
- A2
- A3
- A4
- A5
- A6

Pescara

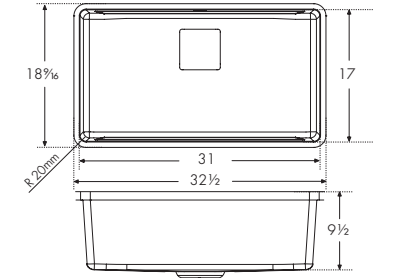

MYTHOS

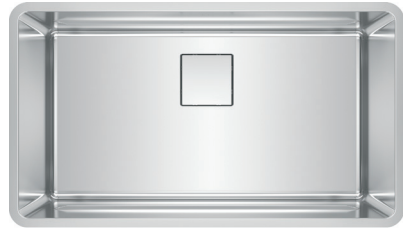

PTX110-31
122.0491.567
\$1,645

Interior Dimensions: 31" x 17" x 9½"
Exterior Dimensions: 32½" x 18¾"
Minimum Cabinet Size: 36"
Gauge: 18
Weight: 23 lbs.
Sound Dampening: Sound Pad
Stainless Finish: Silk
Integral Franke Ledge System
Corner Radius: 20 mm
Installation: Undermount with 3 mm Reveal

Accessories Optional





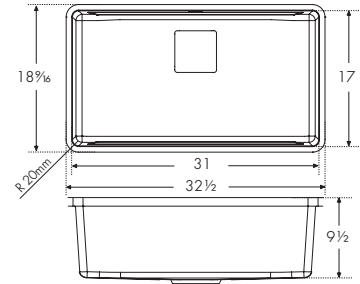

- O2
- O3
- O3
- O5
- O6
- O6
- O8
- O9
- O9

Accessories Included

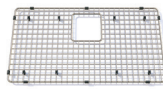
- A1









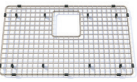
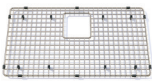

ACCESSORIES INCLUDED

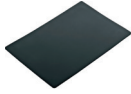
- | | | | | | |
|--|--|--|--|---|---|
| 
A1 Bottom Grid
29½" x 15¼"
Stainless
PT31-36S
112.0491.340
\$240
Included | 
A2 Shelf Grid
14" x 16¼"
Stainless
PT14-31S
112.0490.011
\$190
Included | 
A3 Cutting Board
11" x 18½"
Solid Wood
PT-41S
112.0527.413
\$265
Included | 
A4 Colander
6¾" x 17¾" x 2½"
Stainless
PE-70S
112.0334.171
\$290
Included | 
A5 Strainer Basket
Chrome
1145
112.0055.508
\$80
Included | 
A6 Drain Cover
Stainless
PKGCVR
112.0395.171
\$120
Included |
|--|--|--|--|---|---|

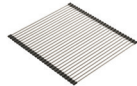
ACCESSORIES OPTIONAL

ACCESSORIES OPTIONAL

- | | | | | | |
|--|---|---|---|--|--|
| 
O1 Bottom Grid
26" x 15¼"
Stainless
PT28-36S
112.0491.339
\$225 | 
O2 Bottom Grid
29¾" x 15¼"
Stainless
PT31-36S
112.0491.340
\$240 | 
O3 Shelf Grid
14" x 16¼"
Stainless
PT14-31S
112.0490.011
\$190 | 
O4 Cutting Board
10¾" x 18½"
Tempered Glass
PT-40S
112.0355.965
\$280 | 
O5 Self-Healing Cutting Mat
9¾" x 14¾"
Silicone
SP-40S
112.0342.598
\$90 | 
O6 Cutting Board
11" x 18½"
Solid Wood
PT-41S
112.0527.413
\$265 |
| 
O7 Colander
6¾" x 17¾" x 2½"
Stainless
PE-70S
112.0334.171
\$290 | 
O8 Universal Roller Mat
18¾" x 20"
Stainless
UV-36RM
112.0391.220
\$225 | 
O9 Strainer Basket
Chrome
1145
112.0055.508
\$80
Satin Nickel
1145SN
112.0185.195
\$115 | 
A1 Drain Cover
Stainless
PKGCVR
112.0395.171
\$120
One included with each bowl. | 
Pescara
Stainless
PES-SPX-304
115.0435.802
\$1,175
Optional | |

Note: All accessories sold separately unless otherwise indicated. Design of custom accessories subject to change without notice. It is absolutely critical that you have the sink and any custom sink accessories on-site prior to any cut or modification to the countertop. Franke will not be responsible for any errors in countertop preparation and sink installation.

MYTHOS

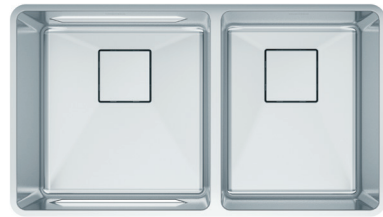

PTX160-31
122.0638.279
\$1,875

Interior Dimensions: 31" x 17" x 8½" & 8"
Exterior Dimensions: 32" x 18"
Minimum Cabinet Size: 36"
Gauge: 18
Weight: 20.5 lbs.
Sound Dampening: Sound Pad
Stainless Finish: Pearl
Integral Franke Ledge System
Corner Radius: 20 mm
Installation: Undermount with 3 mm Reveal

Accessories Optional

O1 O2 O4 O5 O6 O7 O8 O9 O10

Accessories Included

A1

Pescara

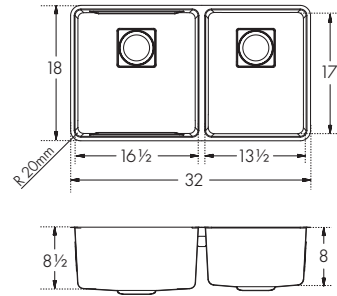

ACCESSORIES OPTIONAL



O1 Bottom Grid
12½" x 15½"
Stainless
PT14-36S
112.0491.334
\$190

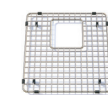

O2 Bottom Grid
15" x 15½"
Stainless
PT17-36S
112.0491.401
\$200

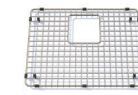

O3 Bottom Grid
20½" x 15½"
Stainless
PT22-36S
112.0491.337
\$210



O4 Shelf Grid
14" x 16¼"
Stainless
PT14-31S
112.0490.011
\$190



O5 Cutting Board
10½" x 18½"
Tempered Glass
PT-40S
112.0355.965
\$280

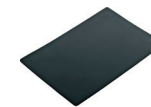

O6 Self-Healing Cutting Mat
9½" x 14½"
Silicone
SP-40S
112.0342.598
\$90



O7 Cutting Board
11" x 18½"
Solid Wood
PT-41S
112.0527.413
\$265



O8 Colander
6¼" x 17¾" x 2¼"
Stainless
PE-70S
112.0334.171
\$290

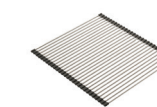

O9 Universal Roller Mat
18¾" x 20"
Stainless
UV-36RM
112.0391.220
\$225



O10 Strainer Basket
Chrome
1145
112.0055.508
\$80
Satin Nickel
1145SN
112.0185.195
\$115

MYTHOS



PTX160-37
122.0638.281
\$1,945

Interior Dimensions: 36½" x 17" x 9½" & 8"
Exterior Dimensions: 38" x 18"
Minimum Cabinet Size: 42"
Gauge: 18
Weight: 25.4 lbs.
Sound Dampening: Sound Pad
Stainless Finish: Pearl
Integral Franke Ledge System
Corner Radius: 20 mm
Installation: Undermount with 3 mm Reveal

Accessories Optional

O1 O3 O4 O5 O6 O7 O8 O9 O10

Accessories Included

A1

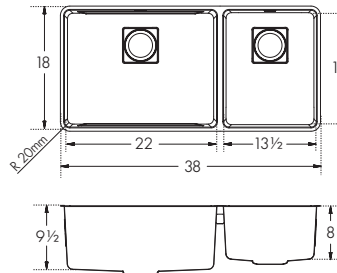

A1 Drain Cover
Stainless
PKGCVR
112.0395.171
\$120
Two included with each double bowl sink.



Pescara
Stainless
PES-SPX-304
115.0435.802
\$1,175

MYTHOS

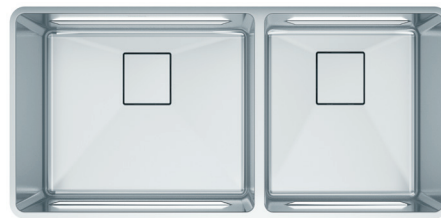

PTX160-40
122.0638.283
\$2,065

Interior Dimensions: 39½" x 17" x 9½" & 8½"
Exterior Dimensions: 41" x 18"
Minimum Cabinet Size: 45"
Gauge: 18
Weight: 27.2 lbs.
Sound Dampening: Sound Pad
Stainless Finish: Pearl
Integral Franke Ledge System
Corner Radius: 20 mm
Installation: Undermount with 3 mm Reveal

Accessories Optional

O2 O3 O4 O5 O6 O7 O8 O9 O10

Accessories Included

A1

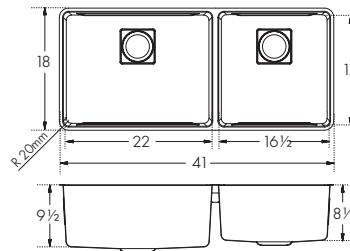

Note: All accessories sold separately unless otherwise indicated. Design of custom accessories subject to change without notice. It is absolutely critical that you have the sink and any custom sink accessories on-site prior to any cut or modification to the countertop. Franke will not be responsible for any errors in countertop preparation and sink installation.

Orca 2.0

A favorite for generations.



The iconic Orca sink is indispensable in the kitchens of home cooks and professional chefs alike. It has long been recognized for its unique design and functionality, thanks to its integrated ledge system that creates a multitiered sink suitable for food preparation and cleaning.



Optimize efficiencies

The Orca 2.0's double-tiered design combines the functions of prepping, serving and cleaning into one work center. Turn the shelf grid into a drying rack while still allowing ample bowl space for washing dishes.



Large capacity sink

The extra room of this generously sized sink will make washing larger items easier. Lay a cookie sheet or roasting pan entirely flat on the bottom of the sink for soaking and cleaning.

Multi-functional space

An efficient prep zone in the kitchen is a must. One way to achieve this is by adding a Franke Orca 2.0 to your kitchen. The Orca 2.0 supports functions in the kitchen by offering an additional workspace and freeing up counter space.



Orca 2.0



OR2X110-S
122.0573.290
\$1,470

Interior Dimensions: 29½" x 18⅞" x 9⅛"
Exterior Dimensions: 30⅞" x 20⅞"
Minimum Cabinet Size: 36"
Gauge: 18
Weight: 24 lbs.
Sound Dampening: Sound Pad
Stainless Finish: Silk
Integral Franke Ledge System
Corner Radius: 30 mm
Installation: Undermount

Accessories Optional

- O1
- O2
- O3
- O4
- O5

Accessories Included

- A1
- A2

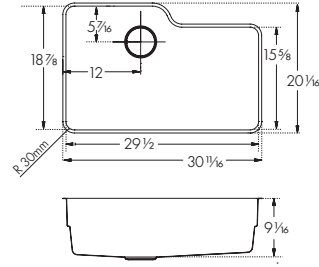

Orca 2.0



OR2X110-WKC
122.0672.203
\$2,155

Interior Dimensions: 29½" x 18⅞" x 9⅛"
Exterior Dimensions: 30⅞" x 20⅞"
Minimum Cabinet Size: 36"
Gauge: 18
Weight: 24 lbs.
Sound Dampening: Sound Pad
Stainless Finish: Silk
Integral Franke Ledge System
Corner Radius: 30 mm

Accessories Included

- A1
- A2
- A3
- A4
- A5
- A6

Accessories Optional

- O1

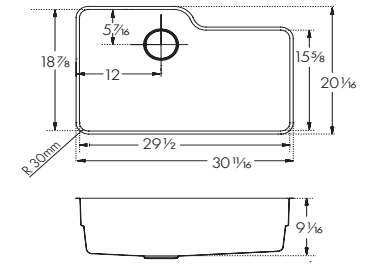

ACCESSORIES OPTIONAL

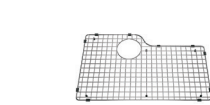

O1 Bottom Grid
27⅞" x 16¼"
Stainless
OC2-36S
112.0570.706
\$295



O2 Shelf Grid Roller Mat
10½" x 15½"
Stainless
OC2-31S-RH
112.0570.710
\$220



O3 Cutting Board
17⅞" x 19⅞"
Solid Wood with
Stainless Colander
OC2-45SP
112.0575.792
\$450



O4 Wire Basket
13¾" x 18½" x 2¾"
Stainless
OC2-50C
112.0570.708
\$220



O5 Inox Cream
Stainless
Steel Polish
903
112.0039.150
\$50

ACCESSORIES INCLUDED



A1 Bottom Grid
27⅞" x 16¼"
Stainless
OC2-36S
112.0570.706
\$295
Included



A2 Shelf Grid Roller Mat
10½" x 15½"
Stainless
OC2-31S-RH
112.0570.710
\$220
Included



A3 Cutting Board
17⅞" x 19⅞"
Solid Wood
with Stainless
Colander
OC2-45SP
112.0575.792
\$450
Included



A4 Drain Cover
4½"
Stainless
RND CVR
112.0532.169
\$120
Included



A5 Strainer Basket
Chrome
1145
112.0055.508
\$80
Included



A6 Wire Basket
13¾" x 18½" x 2¾"
Stainless
OC2-50C
112.0570.708
\$220
Included



A1 Drain Cover
4½"
Stainless
RND CVR
112.0532.169
\$120
Included



A2 Strainer Basket
Chrome
1145
112.0055.508
\$80
Included



Atlas Neo
ATL-PO-304
115.0685.311
\$810
Optional

ACCESSORIES OPTIONAL



O1 Inox Cream
Stainless
Steel Polish
903
112.0039.150
\$50
Optional



Atlas Neo
ATL-PO-304
115.0685.311
\$810
Optional

Prestige

Classic essential style.



Prestige



PCX1102109
122.0312.403
\$925

Interior Dimensions: 21¼" x 18⅞" x 9⅛"
Exterior Dimensions: 22¼" x 19⅞"
Minimum Cabinet Size: 27"
Gauge: 18
Weight: 20 lbs.
Sound Dampening: Sound Pad
Stainless Finish: Silk
Corner Radius: 83 mm
Installation: Undermount

Accessories Optional
O1 O3 O4 O5 O6 O7 O8

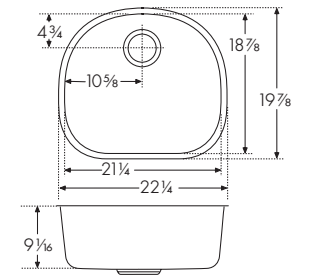

PRX11021
122.0170.020
\$1,070

Interior Dimensions: 21¼" x 18⅞" x 9⅛"
Exterior Dimensions: 22¼" x 19⅞"
Minimum Cabinet Size: 27"
Gauge: 18
Weight: 20 lbs.
Sound Dampening: Sound Pad
Stainless Finish: Silk
Integral Franke Ledge System
Corner Radius: 83 mm
Installation: Undermount

Accessories Optional
O1 O2 O3 O4 O5 O6 O7 O8

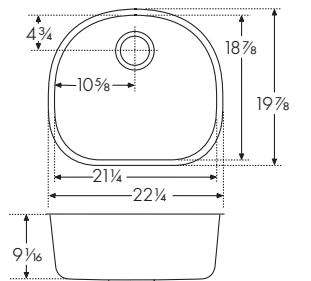

ACCESSORIES OPTIONAL



O1 Bottom Grid
18⅞" x 16⅞"
Stainless
PR-36S
112.0178.198
\$210



O2 Shelf Grid
20⅞" x 13⅞"
Stainless
PR-31S
112.0083.077
\$210



O3 All-In Accessory System 1
AIUS100
112.0655.481
\$280



O4 All-In Accessory System 2
AIUS200
112.0655.488
\$350

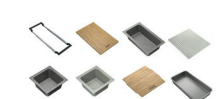

O5 All-In Accessory System 3
AIUS300
112.0655.489
\$420



O6 Strainer Basket
Chrome
1145
112.0055.508
\$80
Satin Nickel
1145SN
112.0185.195
\$115

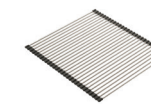

O7 Universal Roller Mat
18⅞" x 20"
Stainless
UV-36RM
112.0391.220
\$225



O8 Inox Cream
Stainless
Steel Polish
903
112.0039.150
\$50
Optional

Note: All accessories sold separately unless otherwise indicated. Design of custom accessories subject to change without notice. It is absolutely critical that you have the sink and any custom sink accessories on-site prior to any cut or modification to the countertop. Franke will not be responsible for any errors in countertop preparation and sink installation.

Regatta

Regatta

Double the function.



RGX160
122.0035.103
\$1,325

Interior Dimensions: 29¹⁵/₁₆" x 18⁷/₈" x 8⁷/₈" & 6⁷/₈"
Exterior Dimensions: 31¹/₂" x 20¹/₂"
Minimum Cabinet Size: 36"
Gauge: 18
Weight: 24 lbs.
Sound Dampening: Sound Pad
Stainless Finish: Silk
Corner Radius: 113 mm
Installation: Undermount

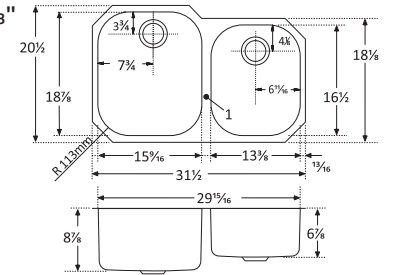

Accessories Optional

O1 O2 O3 O4 O5 O6 O7



ACCESSORIES OPTIONAL



O1 Bottom Grid
13" x 16¹/₁₆"
Stainless
RG-36S
112.0066.265
\$210



O2 Bottom Grid
11¹/₂" x 14¹/₄"
Stainless
RG-36S-RH
112.0066.264
\$210



O3 All-In Accessory System 1
AIUS100
112.0655.481
\$280



O4 All-In Accessory System 2
AIUS200
112.0655.488
\$350

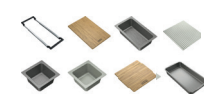

O5 All-In Accessory System 3
AIUS300
112.0655.489
\$420



O6 Strainer Basket
Chrome
1145
112.0055.508
\$80
Satin Nickel
1145SN
112.0185.195
\$115



O7 Inox Cream
Stainless
Steel Polish
903
112.0039.150
\$50
Optional

Cube

Creating a defined space in the kitchen.



Design and functionality

With something to suit every home, the Cube is available in a wide range of sizes and bowl configurations. The Cube sink collection paired with the All-In Accessory Systems is an ideal marriage of design and functionality and they address a high-level segment of kitchen lovers with a minimalist approach.

Deep capacity sink

A sizeable deep sink makes it easy-to-clean cookware and minimizes splashing, offering the form and function you expect from your sink.



Optimal corner radius design

The 12mm corner radius of the sink is simple, contemporary and easy to clean.



Efficient drain

The sloped bottom creates efficient draining, and the rear drain placement provides additional storage below the sink.

Pearl finish

A durable, resilient finish that will stand up to heavy everyday use.



MARIS



CUX11015
122.0371.982
\$850

Interior Dimensions: 15" x 16 1/8" x 9"
Exterior Dimensions: 16 1/2" x 17 3/4"
Minimum Cabinet Size: 21"
Gauge: 18
Weight: 13 lbs.
Sound Dampening: Sound Pad & Spray Coat
Stainless Finish: Pearl
Corner Radius: 12mm
Installation: Undermount

Accessories Optional
O1 O6 O7 O8 O9

Cube

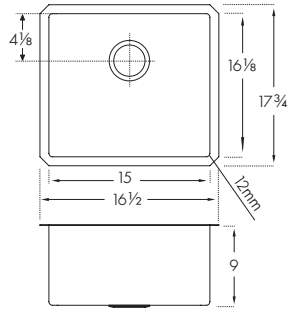

MARIS

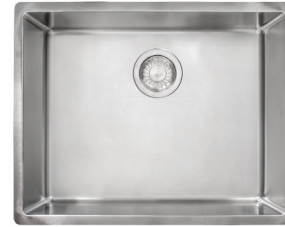

CUX11023
122.0531.788
\$1,025

Interior Dimensions: 23" x 16 1/8" x 9"
Exterior Dimensions: 24 1/16" x 17 1/16"
Minimum Cabinet Size: 30"
Gauge: 18
Weight: 17 lbs.
Sound Dampening: Sound Pad & Spray Coat
Stainless Finish: Pearl
Corner Radius: 12mm
Installation: Undermount

Accessories Optional
O4 O6 O7 O8 O9

Cube

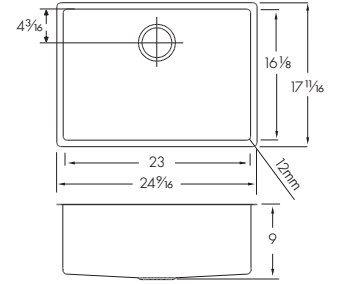

MARIS



CUX11019
122.0627.661
\$895

Interior Dimensions: 18" x 16 1/8" x 9"
Exterior Dimensions: 19 1/16" x 17 3/4"
Minimum Cabinet Size: 24"
Gauge: 18
Weight: 23 lbs.
Sound Dampening: Sound Pad & Spray Coat
Stainless Finish: Pearl
Corner Radius: 12mm
Installation: Undermount

Accessories Optional
O2 O6 O7 O8 O9

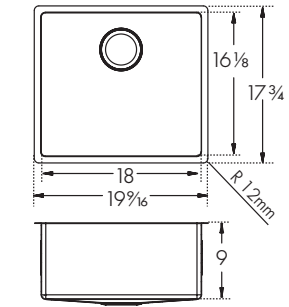

MARIS



CUX11025
122.0479.664
\$1,070

Interior Dimensions: 25" x 16 1/8" x 9"
Exterior Dimensions: 26 5/16" x 17 3/4"
Minimum Cabinet Size: 30"
Gauge: 18
Weight: 18 lbs.
Sound Dampening: Sound Pad & Spray Coat
Stainless Finish: Pearl
Corner Radius: 12mm
Installation: Undermount

Accessories Optional
O5 O6 O7 O8 O9

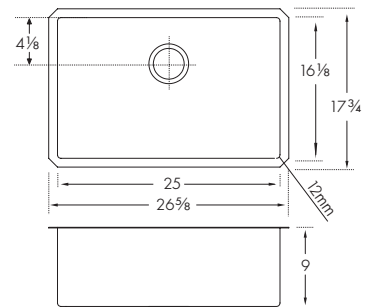

MARIS



CUX11021
122.0371.980
\$990

Interior Dimensions: 21 1/4" x 16 1/8" x 9"
Exterior Dimensions: 22 3/4" x 17 3/4"
Minimum Cabinet Size: 27"
Gauge: 18
Weight: 16 lbs.
Sound Dampening: Sound Pad & Spray Coat
Stainless Finish: Pearl
Corner Radius: 12mm
Installation: Undermount

Accessories Optional
O3 O6 O7 O8 O9

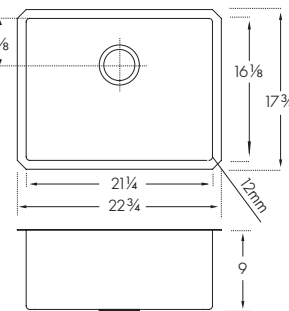

ACCESSORIES OPTIONAL



O1 Bottom Grid
13 3/4" x 15 1/2"
Stainless
CU15-36S
112.0388.962
\$175

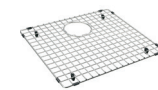

O2 Bottom Grid
17 1/2" x 15 1/2"
Stainless
CU19-36S
112.0627.760
\$195

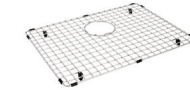

O3 Bottom Grid
20 3/16" x 15 1/2"
Stainless
CU21-36S
112.0388.963
\$200

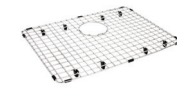

O4 Bottom Grid
22 1/2" x 15 1/2"
Stainless
CU23-36S
112.0533.927
\$205

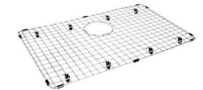

O5 Bottom Grid
24 7/16" x 15 1/2"
Stainless
CU25-36S
112.0488.158
\$210



O6 All-In Accessory System 1
AIUS100
112.0655.481
\$280



O7 All-In Accessory System 2
AIUS200
112.0655.488
\$350

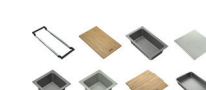

O8 All-In Accessory System 3
AIUS300
112.0655.489
\$420



O9 Strainer Basket
Chrome
1145
112.0055.508
\$80
Satin Nickel
1145SN
112.0185.195
\$115



Eos Neo
Stainless
EOS-PD-304
115.0685.298
\$870

MARIS

Cube



Interior Dimensions: 27" x 16 1/8" x 9"
 Exterior Dimensions: 28 1/2" x 17 3/4"
 Minimum Cabinet Size: 33"
 Gauge: 18
 Weight: 19 lbs.
 Sound Dampening: Sound Pad & Spray Coat
 Stainless Finish: Pearl
 Corner Radius: 12 mm
 Installation: Undermount

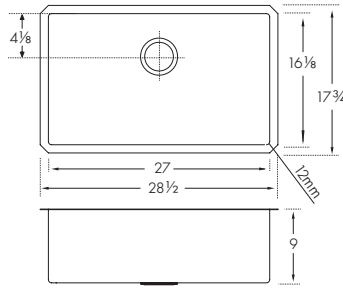

CUX11027
 122.0371.979
\$1,135

Accessories Optional
 O1 O3 O4 O5 O6

MARIS

Cube



Interior Dimensions: 30" x 16 1/8" x 9"
 Exterior Dimensions: 31 1/2" x 17 3/4"
 Minimum Cabinet Size: 36"
 Gauge: 18
 Weight: 21 lbs.
 Sound Dampening: Sound Pad & Spray Coat
 Stainless Finish: Pearl
 Corner Radius: 12 mm
 Installation: Undermount

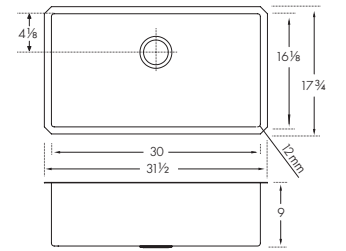

CUX11030-WKC
 122.0672.231
\$1,875

Accessories Included
 A1 A2 A3 A4 A5 A6
 A7 A8 A9 A10

MARIS





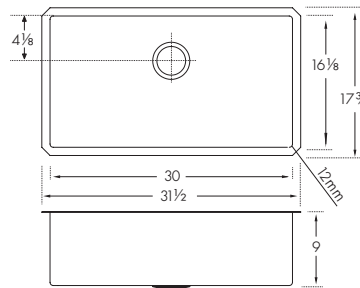





Interior Dimensions: 30" x 16 1/8" x 9"
 Exterior Dimensions: 31 1/2" x 17 3/4"
 Minimum Cabinet Size: 36"
 Gauge: 18
 Weight: 21 lbs.
 Sound Dampening: Sound Pad & Spray Coat
 Stainless Finish: Pearl
 Corner Radius: 12 mm
 Installation: Undermount

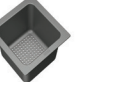
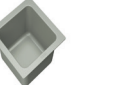

CUX11030
 122.0371.978
\$1,275

Accessories Optional
 O2 O3 O4 O5 O6

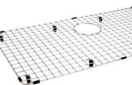
ACCESSORIES INCLUDED

- **A1 Telescopic Bridge**
7" expands to 24"
Stainless
Included
- **A2 Large Bamboo Chopping Board**
8" x 13"
Bamboo
Included
- **A3 Large Colander**
7" x 12" x 3 3/4"
Sanitized"
Polymer
Included
- **A4 Small Colander**
7" x 7" x 3 3/4"
Sanitized"
Polymer
Included
- **A5 Small Bowl**
7" x 7" x 3 3/4"
Sanitized"
Polymer
Included
- **A6 Bamboo Bowl Lid**
7" x 7"
Bamboo
Included
- **A7 Silicone Mat**
14" x 16"
Silicone
Included
- **A8 Storage Container**
11" x 21"
Polymer
Included
- **A9 Bottom Grid**
29 3/4" x 15 3/4"
Stainless
CU30-36S
112.0388.965
\$225
Included
- **A10 Strainer Basket**
Chrome
1145
112.0055.508
\$80
Included
- **Eos Neo**
Stainless
EOS-PD-304
115.0685.298
\$870
Optional

ACCESSORIES OPTIONAL

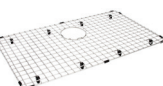
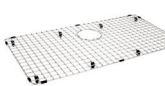
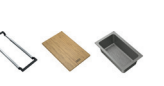
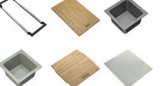
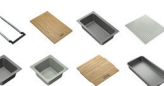
- **O1 Bottom Grid**
26 3/16" x 15 1/8"
Stainless
CU27-36S
112.0388.964
\$220
- **O2 Bottom Grid**
29 3/4" x 15 3/4"
Stainless
CU30-36S
112.0388.965
\$225
- **O3 All-In Accessory System 1**
AIUS100
112.0655.481
\$280
- **O4 All-In Accessory System 2**
AIUS200
112.0655.488
\$350
- **O5 All-In Accessory System 3**
AIUS300
112.0655.489
\$420

- **O6 Strainer Basket**
Chrome
1145
112.0055.508
\$80
Satin Nickel
1145SN
112.0185.195
\$115



Eos Neo
 Stainless
 EOS-PD-304
 115.0685.298
\$870
 Optional

MARIS



CUX16024
122.0627.662
\$1,135

Interior Dimensions: 23⁷/₈" x 16¹/₈" x 9"
Exterior Dimensions: 25⁵/₁₆" x 17¹¹/₁₆"
Minimum Cabinet Size: 30"
Gauge: 18
Weight: 23 lbs.
Sound Dampening: Sound Pad & Spray Coat
Stainless Finish: Pearl
Corner Radius: 12 mm
Installation: Undermount

Accessories Optional
O1 O2 O7 O8 O9 O10

Cube

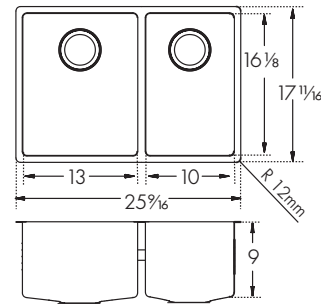

MARIS



CUX16032
122.0627.664
\$1,460

Interior Dimensions: 30⁷/₈" x 16¹/₈" x 9"
Exterior Dimensions: 32⁵/₁₆" x 17¹¹/₁₆"
Minimum Cabinet Size: 36"
Gauge: 18
Weight: 27 lbs.
Sound Dampening: Sound Pad & Spray Coat
Stainless Finish: Pearl
Corner Radius: 12 mm
Installation: Undermount

Accessories Optional
O2 O6 O7 O8 O9 O10

Cube

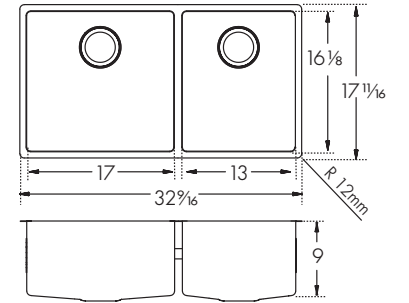

MARIS



CUX160
122.0371.985
\$1,410

Interior Dimensions: 30" x 16¹/₈" x 9"
Exterior Dimensions: 31¹/₂" x 17³/₄"
Minimum Cabinet Size: 36"
Gauge: 18
Weight: 24 lbs.
Sound Dampening: Sound Pad & Spray Coat
Stainless Finish: Pearl
Corner Radius: 12 mm
Installation: Undermount

Accessories Optional
O3 O4 O7 O8 O9 O10

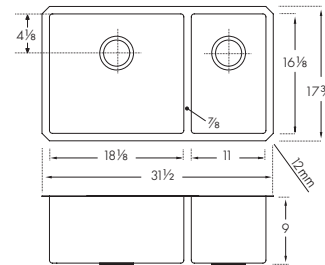

ACCESSORIES OPTIONAL



O1 Bottom Grid
23¹/₂" x 15¹/₂"
Stainless
CU10-36S
112.0628.023
\$145



O2 Bottom Grid
11¹/₄" x 15¹/₂"
Stainless
CU13-36S
112.0627.764
\$160

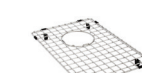

O3 Bottom Grid
10¹/₄" x 15¹/₂"
Stainless
CU11-36S
112.0388.967
\$155

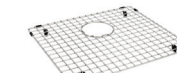

O4 Bottom Grid
17¹/₈" x 15¹/₂"
Stainless
CU18-36S
112.0388.966
\$190

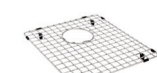

O5 Bottom Grid
13³/₄" x 15¹/₂"
Stainless
CU15-36S
112.0388.962
\$175

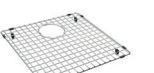

O6 Bottom Grid
16³/₄" x 15¹/₂"
Stainless
CU17-36S
112.0627.763
\$180



O7 All-In Accessory System 1
AIUS100
112.0655.481
\$280



O8 All-In Accessory System 2
AIUS200
112.0655.488
\$350



O9 All-In Accessory System 3
AIUS300
112.0655.489
\$420



O10 Strainer Basket
Chrome
1145
112.0055.508
\$80
Satin Nickel
1145SN
112.0185.195
\$115



Eos Neo
Stainless
EOS-PD-304
115.0685.298
\$870

MARIS



CUX120
122.0371.983
\$1,410

Interior Dimensions: 30" x 16¹/₈" x 9"
Exterior Dimensions: 31¹/₂" x 17³/₄"
Minimum Cabinet Size: 36"
Gauge: 18
Weight: 24 lbs.
Sound Dampening: Sound Pad & Spray Coat
Stainless Finish: Pearl
Corner Radius: 12 mm
Installation: Undermount

Accessories Optional
O5 O7 O8 O9 O10

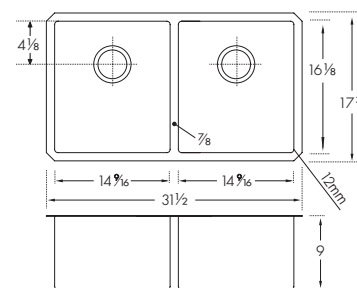

Note: All accessories sold separately unless otherwise indicated. Design of custom accessories subject to change without notice. It is absolutely critical that you have the sink and any custom sink accessories on-site prior to any cut or modification to the countertop. Franke will not be responsible for any errors in countertop preparation and sink installation.

Note: All accessories sold separately unless otherwise indicated. Design of custom accessories subject to change without notice. It is absolutely critical that you have the sink and any custom sink accessories on-site prior to any cut or modification to the countertop. Franke will not be responsible for any errors in countertop preparation and sink installation.

MARIS

Cube ADA



CUX11021-ADA
122.0484.653
\$990

Interior Dimensions: 21¼" x 16⅞" x 5"
Exterior Dimensions: 22¾" x 17¾"
Minimum Cabinet Size: 27"
Gauge: 18
Weight: 16 lbs.
Sound Dampening: Sound Pad
Stainless Finish: Pearl
Corner Radius: 12 mm
Installation: Undermount
ADA Compliant

Accessories Optional

O1 O3 O4 O5 O6

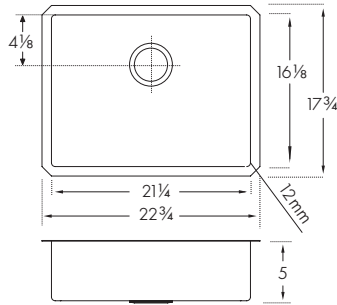

MARIS



CUX11027-ADA
122.0484.656
\$1,135

Interior Dimensions: 27" x 16⅞" x 5"
Exterior Dimensions: 28½" x 17¾"
Minimum Cabinet Size: 33"
Gauge: 18
Weight: 19 lbs.
Sound Dampening: Sound Pad
Stainless Finish: Pearl
Corner Radius: 12 mm
Installation: Undermount
ADA Compliant

Accessories Optional

O2 O3 O4 O5 O6

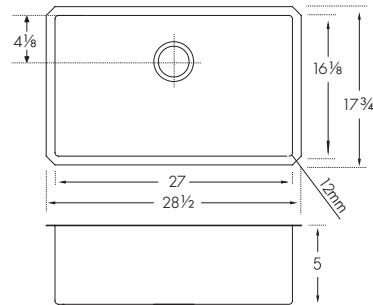

ACCESSORIES OPTIONAL

- 
O1 Bottom Grid
 20¾" x 5⅝"
 Stainless
 CU21-36S
 112.0388.963
\$200
- 
O2 Bottom Grid
 26¾" x 15⅝"
 Stainless
 CU27-36S
 112.0388.964
\$220
- 
O3 All-In Accessory System 1
 AIUS100
 112.0655.481
\$280
- 
O4 All-In Accessory System 2
 AIUS200
 112.0655.488
\$350
- 
O5 All-In Accessory System 3
 AIUS300
 112.0655.489
\$420

- 
O6 Strainer Basket
 Chrome
 1145
 112.0055.508
\$80
 Satin Nickel
 1145SN
 112.0185.195
\$115



Eos Neo
Stainless
EOS-PD-304
115.0685.298
\$870

Grande

Generously proportioned.



Grande



GDX11012
122.0260.550
\$750

Interior Dimensions: 12" x 17" x 8"
Exterior Dimensions: 13³/₄" x 18³/₄"
Minimum Cabinet Size: 18"
Gauge: 18
Weight: 12 lbs.
Sound Dampening: Sound Pad & Spray Coat
Stainless Finish: Silk
Corner Radius: 50 mm
Installation: Undermount

Accessories Optional
O1 O7 O8 O9 O10 O11

See Accessories page 103

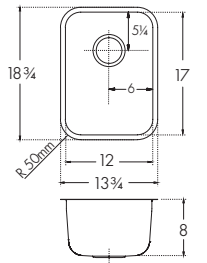

GDX11015
122.0260.551
\$800

Interior Dimensions: 15" x 17" x 9"
Exterior Dimensions: 16³/₄" x 18³/₄"
Minimum Cabinet Size: 21"
Gauge: 18
Weight: 15 lbs.
Sound Dampening: Sound Pad & Spray Coat
Stainless Finish: Silk
Corner Radius: 50 mm
Installation: Undermount

Accessories Optional
O2 O7 O8 O9 O10 O11

See Accessories page 103

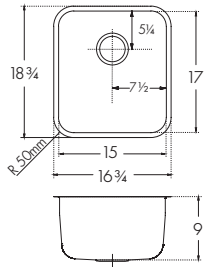

GDX11018
122.0260.552
\$925

Interior Dimensions: 18" x 19³/₄" x 9"
Exterior Dimensions: 19³/₄" x 21¹/₂"
Minimum Cabinet Size: 24"
Gauge: 18
Weight: 17 lbs.
Sound Dampening: Sound Pad & Spray Coat
Stainless Finish: Silk
Corner Radius: 50 mm
Installation: Undermount

Accessories Optional
O3 O7 O8 O9 O10 O11

See Accessories page 103

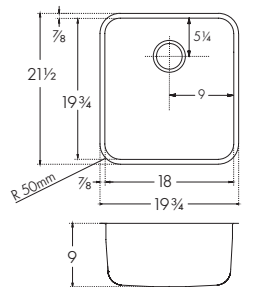

Note: All accessories sold separately unless otherwise indicated. Design of custom accessories subject to change without notice. It is absolutely critical that you have the sink and any custom sink accessories on-site prior to any cut or modification to the countertop. Franke will not be responsible for any errors in countertop preparation and sink installation.

Grande



Interior Dimensions: 23" x 17" x 9"
 Exterior Dimensions: 24¾" x 18¾"
 Minimum Cabinet Size: 30"
 Gauge: 18
 Weight: 21 lbs.
 Sound Dampening: Sound Pad & Spray Coat
 Stainless Finish: Silk
 Corner Radius: 50 mm
 Installation: Undermount

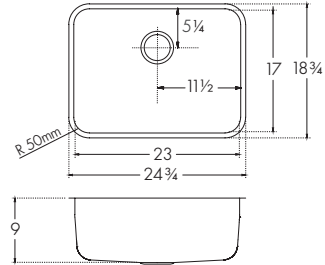

GDX11023
 122.0260.553
\$1,025

Accessories Optional
O4 O7 O8 O9 O10 O11



Interior Dimensions: 28" x 17" x 9"
 Exterior Dimensions: 30⅞" x 19⅞"
 Minimum Cabinet Size: 36"
 Gauge: 18
 Weight: 25 lbs.
 Sound Dampening: Sound Pad & Spray Coat
 Stainless Finish: Silk
 Corner Radius: 70 mm
 Installation: Undermount

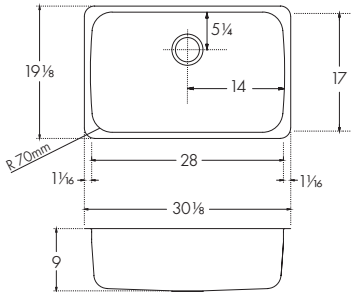

GDX11028
 122.0260.554
\$1,090

Accessories Optional
O5 O7 O8 O9 O10 O11



Interior Dimensions: 31" x 17" x 9"
 Exterior Dimensions: 32¾" x 18¾"
 Minimum Cabinet Size: 36"
 Gauge: 18
 Weight: 28 lbs.
 Sound Dampening: Sound Pad & Spray Coat
 Stainless Finish: Silk
 Corner Radius: 50 mm
 Installation: Undermount

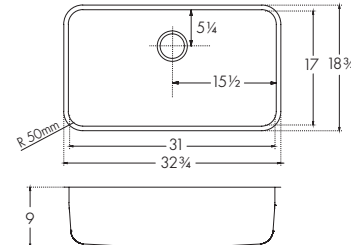

GDX11031
 122.0260.555
\$1,180

Accessories Optional
O6 O7 O8 O9 O10 O11

Grande



Interior Dimensions: 28⅞" x 17" x 9" & 8"
 Exterior Dimensions: 29⅞" x 18¾"
 Minimum Cabinet Size: 36"
 Gauge: 18
 Weight: 20 lbs.
 Sound Dampening: Sound Pad & Spray Coat
 Stainless Finish: Silk
 Corner Radius: 50 mm
 Installation: Undermount

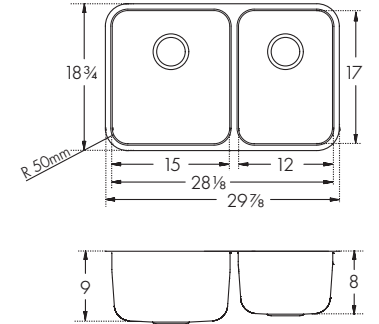

GDX16028RH
 122.0623.413
\$1,310

Accessories Optional
O1 O2 O7 O8 O9 O10 O11

ACCESSORIES OPTIONAL

- | | | | | | |
|--|--|--|--|---|--|
| <p>O1 Bottom Grid
 10½" x 15½"
 Stainless
 GD12-36S
 112.0260.319
 \$175</p> | <p>O2 Bottom Grid
 13¾" x 15½"
 Stainless
 GD15-36S
 112.0260.324
 \$190</p> | <p>O3 Bottom Grid
 16½" x 18¼"
 Stainless
 GD18-36S
 112.0260.325
 \$210</p> | <p>O4 Bottom Grid
 21" x 15"
 Stainless
 BGA2317S
 112.0174.875
 \$175</p> | <p>O5 Bottom Grid
 25⅞" x 15⅝"
 Stainless
 BG90S
 112.0044.794
 \$185</p> | <p>O6 Bottom Grid
 29½" x 15½"
 Stainless
 BGA3117S
 112.0174.878
 \$200</p> |
| <p>O7 All-In Accessory System 1
 AIUS100
 112.0655.481
 \$280</p> | <p>O8 All-In Accessory System 2
 AIUS200
 112.0655.488
 \$350</p> | <p>O9 All-In Accessory System 3
 AIUS300
 112.0655.489
 \$420</p> | <p>O10 Strainer Basket
 Chrome
 1145
 112.0055.508
 \$80
 Satin Nickel
 1145SN
 112.0185.195
 \$115</p> | <p>O11 Inox Cream
 Stainless
 Steel Polish
 903
 112.0039.150
 \$50</p> | |

Grande



GDX12031

122.0187.715
\$1,345

Interior Dimensions: 31 $\frac{1}{8}$ " x 17" x 9"
Exterior Dimensions: 32 $\frac{7}{8}$ " x 18 $\frac{3}{4}$ "
Minimum Cabinet Size: 36"
Gauge: 18
Weight: 29 lbs.
Sound Dampening: Sound Pad & Spray Coat
Stainless Finish: Silk
Corner Radius: 50 mm
Installation: Undermount

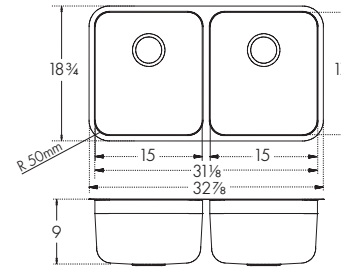

Accessories Optional



GDX16031RH

122.0623.414
\$1,365

Interior Dimensions: 31 $\frac{1}{8}$ " x 17" x 9" x 8"
Exterior Dimensions: 32 $\frac{7}{8}$ " x 18 $\frac{3}{4}$ "
Minimum Cabinet Size: 36"
Gauge: 18
Weight: 27 lbs.
Sound Dampening: Sound Pad & Spray Coat
Stainless Finish: Silk
Corner Radius: 50 mm
Installation: Undermount

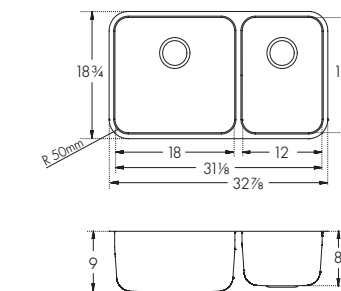

Accessories Optional



ACCESSORIES OPTIONAL



O1 Bottom Grid
13 $\frac{1}{2}$ " x 15 $\frac{1}{2}$ "
Stainless
GD15-36S
112.0260.324
\$190



O2 All-In Accessory System 1
AIUS100
112.0655.481
\$280



O3 All-In Accessory System 2
AIUS200
112.0655.488
\$350

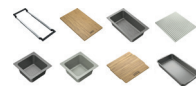

O4 All-In Accessory System 3
AIUS300
112.0655.489
\$420



O5 Strainer Basket
Chrome
1145
112.0055.508
\$80
Satin Nickel
1145SN
112.0185.195
\$115



O6 Inox Cream
Stainless
Steel Polish
903
112.0039.150
\$50



Rotondo

Rotondo

A small wonder.



RBX110-S
101.0067.342
\$550

Interior Dimensions: 14¹⁵/₁₆" x 6¹/₁₆"
Exterior Dimensions: 17¹/₈" x 6¹/₁₆"
Minimum Cabinet Size: 22" (undermount)
18" (topmount)
Gauge: 22
Weight: 5 lbs.
Sound Dampening: Sound Pad
Stainless Finish: Silk
Installation: Undermount
with 3/8" Reveal or Topmount

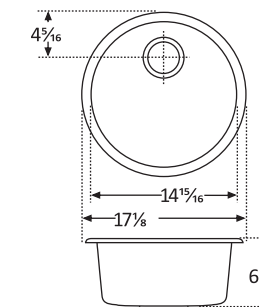

May be used as a topmount (has polished rim).
May be undermounted (requires EL-Clips).
Use interior dimensions as cutout guide.

Accessories Optional

O1 **O2**

Accessories Included

A1

ACCESSORIES OPTIONAL

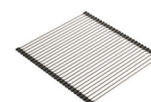

O1 **Universal
Roller Mat**
18⁷/₁₆" x 20"
Stainless
UV-36RM
112.0391.220
\$225



O2 **Inox Cream**
Stainless
Steel Polish
903
112.0039.150
\$50



Eos Neo Bar
Stainless
EOS-BR-304
115.0685.300
\$675

ACCESSORIES INCLUDED



A1 **Strainer
Basket**
906
112.0344.294
\$100

Note: All accessories sold separately unless otherwise indicated. Design of custom accessories subject to change without notice. It is absolutely critical that you have the sink and any custom sink accessories on-site prior to any cut or modification to the countertop. Franke will not be responsible for any errors in countertop preparation and sink installation.

Outdoor Series

A breath of fresh air.



Outdoor Series



ODX110-2310-316
122.0274.293
\$1,135



Interior Dimensions: 23" x 17" x 10"
Exterior Dimensions: 25" x 19"
Minimum Cabinet Size: 30"
Gauge: 18 T316 Stainless Steel
Weight: 31 lbs.
Sound Dampening: Sound Pad & Spray Coat
Finish: Pearl
Corner Radius: 10 mm
Installation: Undermount with 1/2" Reveal

Accessories Included

A1 A2

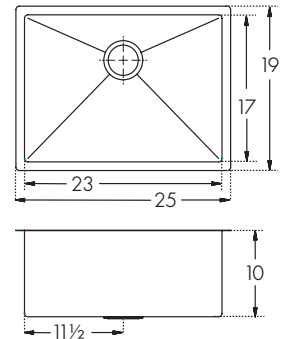

ODX110-2312-316
122.0274.294
\$1,205



Interior Dimensions: 23" x 17" x 12"
Exterior Dimensions: 25" x 19"
Minimum Cabinet Size: 30"
Gauge: 18 T316 Stainless Steel
Weight: 31 lbs.
Sound Dampening: Sound Pad & Spray Coat
Finish: Pearl
Corner Radius: 10 mm
Installation: Undermount with 1/2" Reveal

Accessories Included

A1 A2

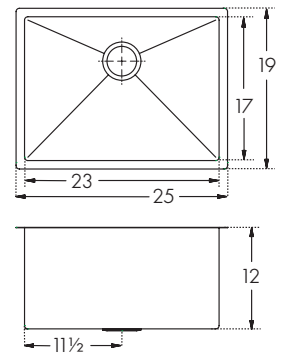

ACCESSORIES INCLUDED

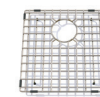

A1 Bottom Grid
22 1/4" x 16 1/4"
Stainless
PS23-36S
112.0194.704
\$310
Included



A2 Strainer Basket
Stainless
1140F-316
253.0221.355
\$115
Included



Eos Neo
Stainless 316
EOS-PD-316
115.0685.297
\$1,005
Optional

Note: All accessories sold separately unless otherwise indicated. Design of custom accessories subject to change without notice. It is absolutely critical that you have the sink and any custom sink accessories on-site prior to any cut or modification to the countertop. Franke will not be responsible for any errors in countertop preparation and sink installation.



Maris 116
Workcenters 136
Peak 140
Ellipse 146



Granite

Sinks

Made to last

A durable and beautiful choice, Franke's granite sinks are made from up to 80% natural quartz sand, making them one of the hardest materials in the world.

Quartz sand is delivered to the factory in various colors, which creates the finished color of each sink. However, all our sinks reflect the latest kitchen color trends and echo your style and taste, with calming and classic neutrals that have never lost their appeal. We know what matters most in the home — beauty, functionality, simplicity. It is a hardworking haven that nurtures our spirits and promotes our well-being.

COLOR VARIATIONS

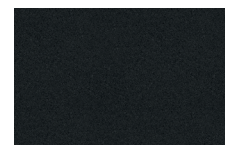

Matte Black

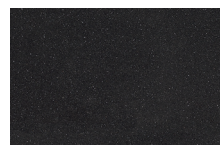

Onyx



NEW Slate Grey

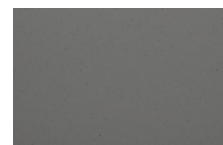

Stone Grey

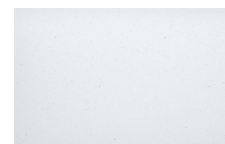

Polar White

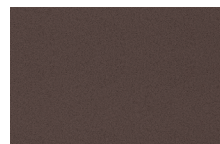

Mocha

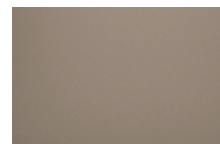

Oyster



Champagne



Colorline

Colors that create perfect harmony.



Perfectly matched strainers and drain covers



Seven colors available in two styles, strainer basket and waste disposer flange with strainer basket.



Matte Black/
Onyx



Stone
Grey



Polar
White

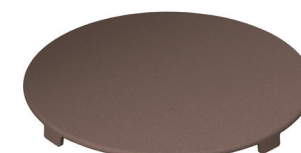

Mocha

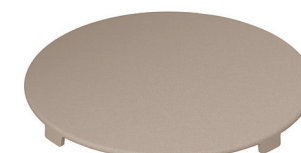

Oyster

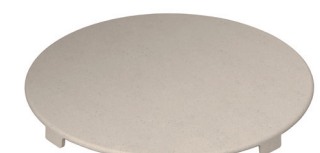

Champagne

Maris

Usher in a new era.



Home in harmony

We've entered a new era of living, where balance means everything. In this age, we don't just hope for harmony, we create it. Through clever features, unparalleled function and elegant design, Franke Maris granite sinks are created to empower your contemporary idea of balance.



Make your space work for you

With a low-divide sink you can keep your kitchen in check. The double bowl allows you to multitask with ease, while the low divide creates a larger single bowl that is perfect for cleaning cookware and bakeware.



Integrated for balance

Organization is at the heart of balance. With our easy-to-use integrated ledge system, you'll accomplish more with your sink while making the most of your surrounding counter space.



Add a strainer

For an additional \$70 to the list price (\$140 for double bowls), add a 1145 strainer basket to any Maris sink on the following pages. Simply add "-S" to the end of the model number, ie: MAG11023-PWT-S.

A fresh start in every detail

Beautiful granite finishes are enhanced with Sanitized® Technology that works consistently to neutralize odors and reduce bacteria and microbe growth by 99%. A safer home for you and your family starts with cleaner surfaces.



MARIS



MAG11020
\$680

Interior Dimensions: 20¹/₁₆" x 15⁹/₁₆" x 9¹/₂"
Exterior Dimensions: 21⁵/₈" x 17¹³/₁₆"
Minimum Cabinet Size: 24"
Weight: 31 lbs.
Corner Radius: 16mm
Installation: Undermount

Accessories Optional

O1 O4 O6 O8 O10 O11 O12 O13

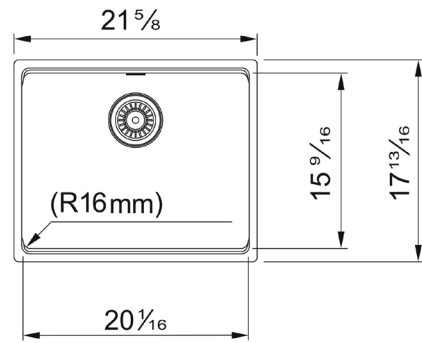

- Polar White
MAG11020-PWT
125.0710.345
\$680
- Stone Grey
MAG11020-SHG
125.0710.350
\$680
- NEW** Slate Grey
MAG11020-SLG
125.0713.102
\$680
- Onyx
MAG11020-ONY
125.0710.343
\$680
- Matte Black
MAG11020-MBK
125.0710.340
\$680
- Champagne
MAG11020-CHA
125.0710.339
\$680
- Oyster
MAG11020-OYS
125.0710.344
\$680
- Mocha
MAG11020-MOC
125.0710.341
\$680

Maris

MARIS



MAG11025
\$720

Interior Dimensions: 25¹/₂" x 16¹¹/₁₆" x 9¹/₂"
Exterior Dimensions: 27" x 19"
Minimum Cabinet Size: 30"
Weight: 33 lbs.
Corner Radius: 16mm
Installation: Undermount

Accessories Optional

O3 O5 O7 O9 O10 O11 O12 O13

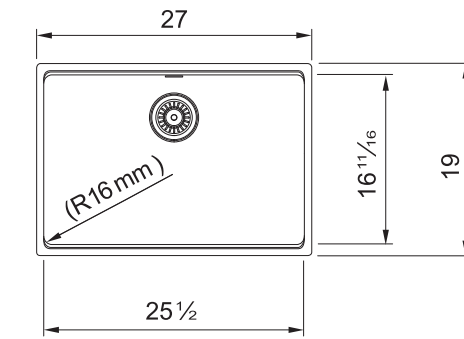

- Polar White
MAG11025-PWT
125.0687.027
\$720
- Stone Grey
MAG11025-SHG
125.0687.028
\$720
- NEW** Slate Grey
MAG11025-SLG
125.0713.108
\$720
- Onyx
MAG11025-ONY
125.0687.025
\$720
- Matte Black
MAG11025-MBK
125.0687.023
\$720
- Champagne
MAG11025-CHA
125.0687.022
\$720
- Oyster
MAG11025-OYS
125.0687.026
\$720
- Mocha
MAG11025-MOC
125.0687.024
\$720

MARIS



MAG11023
\$695

Interior Dimensions: 23⁷/₁₆" x 16¹¹/₁₆" x 9¹/₂"
Exterior Dimensions: 25" x 18¹⁵/₁₆"
Minimum Cabinet Size: 30"
Weight: 33 lbs.
Corner Radius: 16mm
Installation: Undermount

Accessories Optional

O2 O5 O7 O9 O10 O11 O12 O13

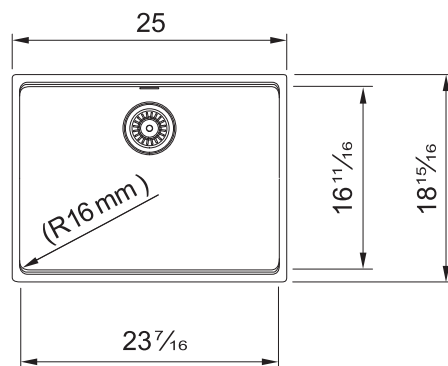

- Polar White
MAG11023-PWT
125.0687.034
\$695
- Stone Grey
MAG11023-SHG
125.0687.035
\$695
- NEW** Slate Grey
MAG11023-SLG
125.0713.106
\$695
- Onyx
MAG11023-ONY
125.0687.032
\$695
- Matte Black
MAG11023-MBK
125.0687.030
\$695
- Champagne
MAG11023-CHA
125.0687.029
\$695
- Oyster
MAG11023-OYS
125.0687.033
\$695
- Mocha
MAG11023-MOC
125.0687.031
\$695

ACCESSORIES OPTIONAL

- | | | | | | | |
|---|---|--|--|---|--|---|
| <p>O1 Bottom Grid
18¹/₁₆" x 14"
Stainless
MA-20-36S
112.0709.442
\$245</p> | <p>O2 Bottom Grid
21¹/₈" x 15¹/₈"
Stainless
MA-23-36S
112.0687.977
\$255</p> | <p>O3 Bottom Grid
23¹/₁₆" x 15¹/₈"
Stainless
MA-25-36S
112.0687.978
\$265</p> | <p>O4 Colander
6¹/₈" x 16"
Stainless
MAC-70S
112.0688.103
\$255</p> | <p>O5 Colander
6¹/₈" x 17¹/₈" x 2¹/₈"
Stainless
PX-70S
112.0066.060
\$280</p> | <p>O6 Cutting Board
11¹/₈" x 16¹/₈"
Maple
MAC-40S
112.0688.104
\$225</p> | <p>O7 Maple Cutting Board
11¹/₈" x 18"
Solid Wood
MA2-40S
112.0688.102
\$225</p> |
| <p>O8 Roller Mat
11¹/₈" x 16¹/₈"
Stainless
PKG14-31RM
112.0256.867
\$175</p> | <p>O9 Roller Mat
18¹/₈" x 17¹/₈"
Stainless
MA2-31RM
112.0080.355
\$190</p> | <p>O10 Strainer Basket
Chrome
1145
112.0055.508
\$80
Satin Nickel
1145SN
112.0185.195
\$115</p> | <p>O11 Colorline Strainer Basket
900-PWT
900-SHG
900-SLG
900-MBK
900-CHA
900-OYS
900-MOC
Color shown is Champagne
\$100</p> | <p>O12 Colorline Disposer Flange Kit
WD-900-PWT
WD-900-SHG
WD-900-SLG
WD-900-MBK
WD-900-CHA
WD-900-OYS
WD-900-MOC
Color shown is Matte Black
\$115</p> | <p>O13 Colorline Drain Cover
4¹/₂"
RNDCVR-PWT
RNDCVR-SHG
RNDCVR-SLG
RNDCVR-MBK
RNDCVR-CHA
RNDCVR-OYS
RNDCVR-MOC
Color shown is Stainless
\$65</p> | |

MARIS



MAG11028
\$745

Interior Dimensions: 28⁷/₁₆" x 16⁵/₈" x 9¹/₂"
Exterior Dimensions: 30" x 19"
Minimum Cabinet Size: 33"
Weight: 34 lbs.
Corner Radius: 16mm
Installation: Undermount

Accessories Optional
O1 O5 O7 O9 O10 O11 O12 O13

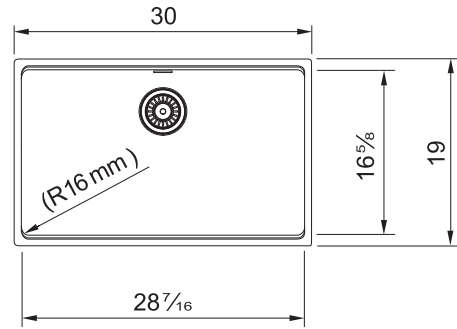

Maris

-  Polar White
MAG11028-PWT
125.0687.020
\$745
-  Stone Grey
MAG11028-SHG
125.0687.021
\$745
-  **NEW** Slate Grey
MAG11028-SLG
125.0713.110
\$745
-  Onyx
MAG11028-ONY
125.0687.018
\$745
-  Matte Black
MAG11028-MBK
125.0687.016
\$745
-  Champagne
MAG11028-CHA
125.0687.015
\$745
-  Oyster
MAG11028-OYS
125.0687.019
\$745
-  Mocha
MAG11028-MOC
125.0687.017
\$745

MARIS









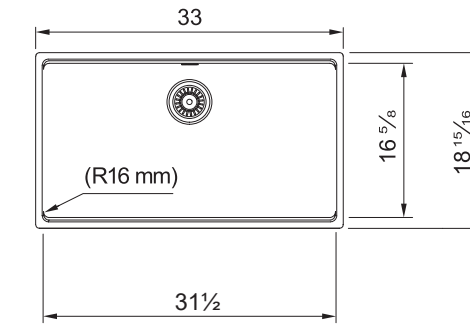

MAG11031
\$775

Interior Dimensions: 31¹/₂" x 16⁵/₈" x 9¹/₂"
Exterior Dimensions: 33" x 18¹⁵/₁₆"
Minimum Cabinet Size: 36"
Weight: 37 lbs.
Corner Radius: 16mm
Installation: Undermount

Accessories Optional
O3 O5 O7 O9 O10 O11 O12 O13



-  Polar White
MAG11031-PWT
125.0686.937
\$775
-  Stone Grey
MAG11031-SHG
125.0686.939
\$775
-  **NEW** Slate Grey
MAG11031-SLG
125.0713.114
\$775
-  Onyx
MAG11031-ONY
125.0686.935
\$775
-  Matte Black
MAG11031-MBK
125.0686.967
\$775
-  Champagne
MAG11031-CHA
125.0686.966
\$775
-  Oyster
MAG11031-OYS
125.0686.936
\$775
-  Mocha
MAG11031-MOC
125.0686.968
\$775

MARIS





MAG11029
\$765



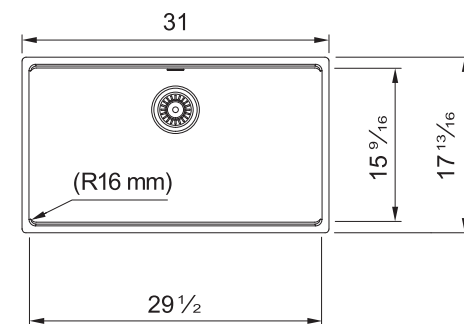









Interior Dimensions: 29¹/₂" x 15⁹/₁₆" x 9¹/₂"
Exterior Dimensions: 31" x 17¹³/₁₆"
Minimum Cabinet Size: 36"
Weight: 35 lbs.
Corner Radius: 16mm
Installation: Undermount

Accessories Optional
O2 O4 O6 O8 O10 O11 O12 O13

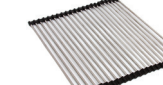
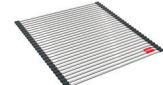

-  Polar White
MAG11029-PWT
125.0687.097
\$765
-  Stone Grey
MAG11029-SHG
125.0687.098
\$765
-  **NEW** Slate Grey
MAG11029-SLG
125.0713.112
\$765
-  Onyx
MAG11029-ONY
125.0687.095
\$765
-  Matte Black
MAG11029-MBK
125.0687.093
\$765
-  Champagne
MAG11029-CHA
125.0687.092
\$765
-  Oyster
MAG11029-OYS
125.0687.096
\$765
-  Mocha
MAG11029-MOC
125.0687.094
\$765

ACCESSORIES OPTIONAL

-  **O1 Bottom Grid**
26⁹/₁₆" x 15¹/₈"
Stainless
MA-28-36S
112.0687.979
\$285
-  **O2 Bottom Grid**
27⁹/₁₆" x 14"
Stainless
MA-29-36S
112.0687.980
\$295
-  **O3 Bottom Grid**
29⁹/₁₆" x 15¹/₈"
Stainless
MA2-31-36S
112.0687.991
\$310
-  **O4 Colander**
6¹/₂" x 16"
Stainless
MAC-70S
112.0688.103
\$255
-  **O5 Colander**
6¹/₂" x 17¹/₈" x 2¹/₂"
Stainless
PX-70S
112.0066.060
\$280
-  **O6 Cutting Board**
11¹/₂" x 16¹/₂"
Maple
MAC-40S
112.0688.104
\$225
-  **O7 Cutting Board**
11¹/₂" x 18"
Maple
MA2-40S
112.0688.102
\$225
-  **O8 Roller Mat**
11¹/₂" x 16¹/₂"
Stainless
PKG14-31RM
112.0256.867
\$175
-  **O9 Roller Mat**
18¹/₈" x 17¹/₈"
Stainless
MA2-31RM
112.0080.355
\$190
-  **O10 Strainer Basket**
Chrome
1145
112.0055.508
\$80
Satin Nickel
1145SN
112.0185.195
\$115
-  **O11 Colorline Strainer Basket**
900-PWT
900-SHG
900-SLG
900-MBK
900-CHA
900-OYS
900-MOC
\$100
Color shown is Champagne
-  **O12 Colorline Disposer Flange Kit**
WD-900-PWT
WD-900-SHG
WD-900-SLG
WD-900-MBK
WD-900-CHA
WD-900-OYS
WD-900-MOC
\$115
Color shown is Matte Black
-  **O13 Colorline Drain Cover**
4¹/₂"
RND-CVR-PWT
RND-CVR-SHG
RND-CVR-SLG
RND-CVR-MBK
RND-CVR-CHA
RND-CVR-OYS
RND-CVR-MOC
\$65
RND-CVR
Stainless
112.0532.169
\$120
Color shown is Stainless
-  **Active Matte Black ACT-PO-MBK**
115.0656.848
\$855

Maris



Interior Dimensions: 31¹/₁₆" x 17" x 9¹/₂"
 Exterior Dimensions: 33" x 19⁵/₁₆"
 Minimum Cabinet Size: 36"
 Weight: 38lbs.
 Corner Radius: 16mm
 Installation: Undermount

Accessories Optional
 O1 O2 O3 O4 O5 O6 O7 O8

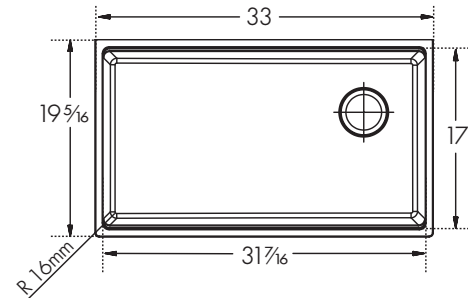

MAG110310W
\$775

NEW

- Polar White
MAG110310W-PWT
 125.0637.078
\$775
- Stone Grey
MAG110310W-SHG
 125.0637.077
\$775
- Slate Grey
MAG110310W-SLG
 125.0713.100
\$775
- Onyx
MAG110310W-ONY
 125.0637.076
\$775
- Matte Black
MAG110310W-MBK
 125.0637.082
\$775
- Champagne
MAG110310W-CHA
 125.0637.081
\$775
- Oyster
MAG110310W-OYS
 125.0637.080
\$775
- Mocha
MAG110310W-MOC
 125.0688.136
\$775

Maris



Interior Dimensions: 31¹/₁₆" x 17" x 9¹/₂"
 Exterior Dimensions: 33" x 19⁵/₁₆"
 Minimum Cabinet Size: 36"
 Weight: 45 lbs.
 Corner Radius: 16mm
 Installation: Undermount

Accessories Included
 A1 A2 A3 A4

Accessories Optional
 O1 O2 O3 O4



MAG110310W-WKC
\$1,420

NEW

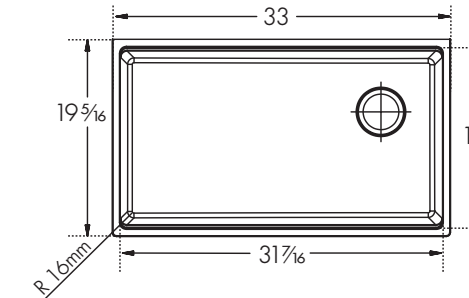
- Polar White
MAG110310W-PWT-WKC
 125.0672.247
\$1,420
- Stone Grey
MAG110310W-SHG-WKC
 125.0672.248
\$1,420
- Slate Grey
MAG110310W-SLG-WKC
 125.0715.372
\$1,420
- Onyx
MAG110310W-ONY-WKC
 125.0672.243
\$1,420
- Matte Black
MAG110310W-MBK-WKC
 125.0672.245
\$1,420
- Champagne
MAG110310W-CHA-WKC
 125.0672.244
\$1,420
- Oyster
MAG110310W-OYS-WKC
 125.0672.246
\$1,420
- Mocha
MAG110310W-MOC-WKC
 125.0688.140
\$1,420



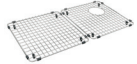

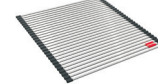

ACCESSORIES OPTIONAL

- 
O1 Bottom/ Shelf Grid
 (Left) 14¹/₈" x 15¹/₁₆"
 (Right) 14¹/₈" x 15¹/₁₆"
 Stainless
 MA-31-36S
 112.0643.593
\$310
- 
O2 Colander
 6¹/₈" x 17¹/₁₆" x 2¹/₁₆"
 Stainless
 PE-70S
 112.0334.171
\$290
- 
O3 Cutting Board
 11¹/₈" x 18¹/₁₆"
 Maple
 MA3-40S
 112.0643.597
\$225
- 
O4 Roller Mat
 18¹/₈" x 17¹/₁₆"
 Stainless
 MA-31RM
 112.0643.591
\$190

- 
O5 Strainer Basket
 Chrome
 1145
 112.0055.508
\$80
 Satin Nickel
 1145SN
 112.0185.195
\$115
- 
O6 Colorline Strainer Basket
 900-PWT
 900-SHG
 900-SLG
 900-MBK
 900-CHA
 900-OYS
 900-MOC
\$100
 Color shown is Champagne
- 
O7 Colorline Disposer Flange Kit
 WD-900-PWT
 WD-900-SHG
 WD-900-SLG
 WD-900-MBK
 WD-900-CHA
 WD-900-OYS
 WD-900-MOC
\$115
 Color shown is Matte Black
- 
O8 Colorline Drain Cover
 4¹/₂"
 RNDCVR-PWT
 RNDCVR-SHG
 RNDCVR-SLG
 RNDCVR-MBK
 RNDCVR-CHA
 RNDCVR-OYS
 RNDCVR-MOC
\$65
 RNDCVR
 Stainless
 112.0532.169
\$120
 Color shown is Stainless

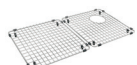

ACCESSORIES INCLUDED

- 
A1 Bottom/ Shelf Grid
 (Left) 14¹/₈" x 15¹/₁₆"
 (Right) 14¹/₈" x 15¹/₁₆"
 Stainless
 MA-31-36S
 112.0643.593
\$310
- 
A2 Colander
 6¹/₈" x 17¹/₁₆" x 2¹/₁₆"
 Stainless
 PE-70S
 112.0334.171
\$290
- 
A3 Cutting Board
 11¹/₈" x 18¹/₁₆"
 Maple
 MA3-40S
 112.0643.597
\$225
- 
A4 Strainer Basket
 Chrome
 1145
 112.0055.508
\$80
 Satin Nickel
 1145SN
 112.0185.195
\$115
 Optional

ACCESSORIES OPTIONAL

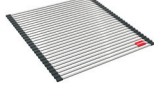
- 
O1 Roller Mat
 18¹/₈" x 17¹/₁₆"
 Stainless
 MA-31RM
 112.0643.591
\$190
- 
O2 Colorline Strainer Basket
 900-PWT
 900-SHG
 900-SLG
 900-MBK
 900-CHA
 900-OYS
 900-MOC
\$100
 Color shown is Champagne
- 
O3 Colorline Disposer Flange Kit
 WD-900-PWT
 WD-900-SHG
 WD-900-SLG
 WD-900-MBK
 WD-900-CHA
 WD-900-OYS
 WD-900-MOC
\$115
 Color shown is Matte Black
- 
O4 Colorline Drain Cover
 4¹/₂"
 RNDCVR-PWT
 RNDCVR-SHG
 RNDCVR-SLG
 RNDCVR-MBK
 RNDCVR-CHA
 RNDCVR-OYS
 RNDCVR-MOC
\$65
 RNDCVR
 Stainless
 112.0532.169
\$120
 Color shown is Stainless



Maris



MAG1201414
\$810

Interior Dimensions: 29½" x 15⁹/₁₆" x 9½"
Exterior Dimensions: 31" x 17¹³/₁₆"
Minimum Cabinet Size: 36"
Weight: 40 lbs.
Corner Radius: 16mm
Installation: Undermount

Accessories Optional

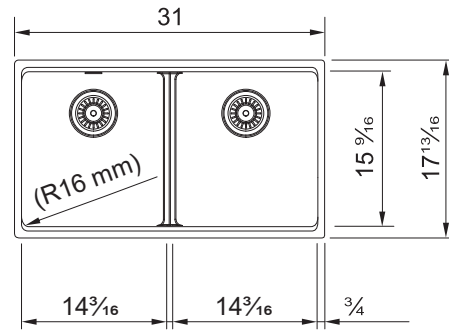

- Polar White
MAG1201414-PWT
125.0687.069
\$810
- Stone Grey
MAG1201414-SHG
125.0687.070
\$810
- NEW** Slate Grey
MAG1201414-SLG
125.0713.116
\$810
- Onyx
MAG1201414-ONY
125.0687.067
\$810
- Matte Black
MAG1201414-MBK
125.0687.065
\$810
- Champagne
MAG1201414-CHA
125.0687.064
\$810
- Oyster
MAG1201414-OYS
125.0687.068
\$810
- Mocha
MAG1201414-MOC
125.0687.066
\$810



MAG1601611LD
\$810

Interior Dimensions: 29½" x 15⁹/₁₆" x 9½"
Exterior Dimensions: 31" x 17¹³/₁₆"
Minimum Cabinet Size: 36"
Weight: 39 lbs.
Corner Radius: 16mm
Installation: Undermount

Accessories Optional

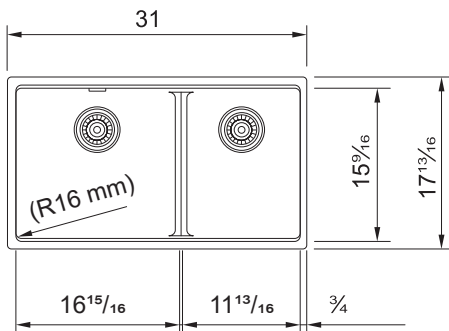

- Polar White
MAG1601611LD-PWT
125.0687.083
\$810
- Stone Grey
MAG1601611LD-SHG
125.0687.084
\$810
- NEW** Slate Grey
MAG1601611LD-SLG
125.0713.120
\$810
- Onyx
MAG1601611LD-ONY
125.0687.081
\$810
- Matte Black
MAG1601611LD-MBK
125.0687.079
\$810
- Champagne
MAG1601611LD-CHA
125.0687.078
\$810
- Oyster
MAG1601611LD-OYS
125.0687.082
\$810
- Mocha
MAG1601611LD-MOC
125.0687.080
\$810

Maris



MAG1601812LD
\$840

Interior Dimensions: 31½" x 16¹¹/₁₆" x 9½"
Exterior Dimensions: 33" x 18¹⁵/₁₆"
Minimum Cabinet Size: 36"
Weight: 40 lbs.
Corner Radius: 16mm
Installation: Undermount

Accessories Optional

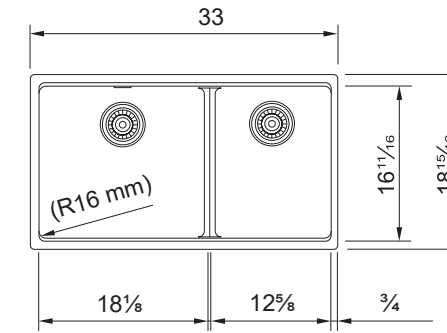

- Polar White
MAG1601812LD-PWT
125.0687.006
\$840
- Stone Grey
MAG1601812LD-SHG
125.0687.007
\$840
- NEW** Slate Grey
MAG1601812LD-SLG
125.0713.122
\$840
- Onyx
MAG1601812LD-ONY
125.0687.004
\$840
- Matte Black
MAG1601812LD-MBK
125.0687.002
\$840
- Champagne
MAG1601812LD-CHA
125.0687.001
\$840
- Oyster
MAG1601812LD-OYS
125.0687.005
\$840
- Mocha
MAG1601812LD-MOC
125.0687.003
\$840

ACCESSORIES OPTIONAL

- | | | | | | |
|---|--|--|---|--|--|
| <p>O1 Bottom Grid
12¾" x 14"
Stainless
MA-14-36S
112.0687.992
\$200</p> | <p>O2 Bottom Grid
15¾" x 14"
Stainless
MA-16-36S
112.0687.994
\$225</p> | <p>O3 Bottom Grid
10¾" x 14"
Stainless
MA-11-36S
112.0687.995
\$180</p> | <p>O4 Bottom Grid
16¾" x 15¾"
Stainless
MA-18-36S
112.0687.996
\$235</p> | <p>O5 Bottom Grid
11¾" x 15¾"
Stainless
MA-12-36S
112.0687.997
\$190</p> | <p>O6 Colander
6¾" x 16"
Stainless
MAC-70S
112.0688.103
\$255</p> |
| <p>O7 Colander
6¾" x 17¾" x 2¾"
Stainless
PX-70S
112.0066.060
\$280</p> | <p>O8 Cutting Board
11¾" x 16¾"
Maple
MAC-40S
112.0688.104
\$225</p> | <p>O9 Cutting Board
11¾" x 18"
Solid Wood
MA2-40S
112.0688.102
\$225</p> | <p>O10 Roller Mat
11¾" x 16¾"
Stainless
PKG14-31RM
112.0256.867
\$175</p> | <p>O11 Roller Mat
18¾" x 17¾"
Stainless
MA2-31RM
112.0080.355
\$190</p> | <p>O12 Strainer Basket
Chrome
1145
112.0055.508
\$80
Satin Nickel
1145SN
112.0185.195
\$115</p> |
| <p>O13 Colorline Strainer Basket
900-PWT
900-SHG
900-SLG
900-MBK
900-CHA
900-OYS
900-MOC
\$100
Color shown is Champagne</p> | <p>O14 Colorline Disposer Flange Kit
WD-900-PWT
WD-900-SHG
WD-900-SLG
WD-900-MBK
WD-900-CHA
WD-900-OYS
WD-900-MOC
\$115
Color shown is Matte Black</p> | <p>O15 Colorline Drain Cover
4½"
RNDCVR-PWT
RNDCVR-SHG
RNDCVR-SLG
RNDCVR-MBK
RNDCVR-CHA
RNDCVR-OYS
RNDCVR-MOC
\$65
RNDCVR
Stainless
112.0532.169
\$120
Color shown is Stainless</p> | <p>Active
Matte Black
ACT-PO-MBK
115.0656.848
\$855</p> | | |

Note: All accessories sold separately unless otherwise indicated. Design of custom accessories subject to change without notice. It is absolutely critical that you have the sink and any custom sink accessories on-site prior to any cut or modification to the countertop. Franke will not be responsible for any errors in countertop preparation and sink installation.

MARIS



MAG1201515
\$840

Interior Dimensions: 31½" x 16¹¹/₁₆" x 9½"
Exterior Dimensions: 33" x 18¹⁵/₁₆"
Minimum Cabinet Size: 36"
Weight: 43 lbs.
Corner Radius: 16mm
Installation: Undermount

Accessories Optional

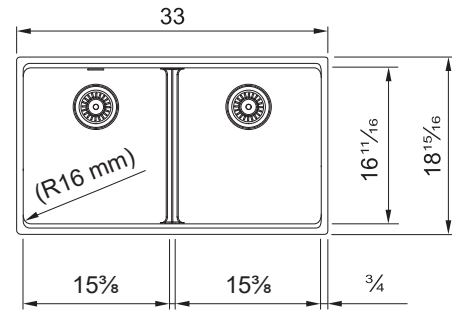

- Polar White
MAG1201515-PWT
125.0686.992
\$840
- Stone Grey
MAG1201515-SHG
125.0686.993
\$840
- NEW** Slate Grey
MAG1201515-SLG
125.0713.118
\$840
- Onyx
MAG1201515-ONY
125.0686.990
\$840
- Matte Black
MAG1201515-MBK
125.0686.988
\$840
- Champagne
MAG1201515-CHA
125.0686.987
\$840
- Oyster
MAG1201515-OYS
125.0686.991
\$840
- Mocha
MAG1201515-MOC
125.0686.989
\$840

Maris

MARIS



MAG61020
\$665

Interior Dimensions: 20¹/₁₆" x 15⁹/₁₆" x 9½"
Exterior Dimensions: 21⁵/₈" x 20⁷/₈"
Minimum Cabinet Size: 24"
Weight: 33 lbs.
Corner Radius: 16mm
Installation: Topmount
Pre-scored Faucet Hole: 1 to 4

Accessories Optional

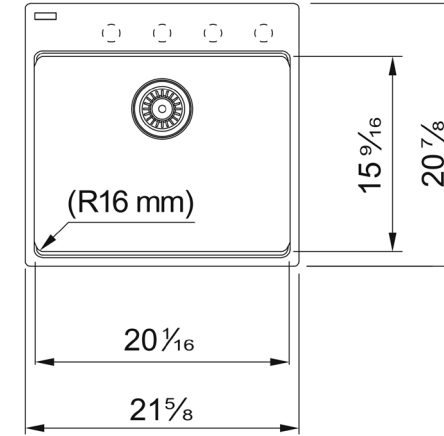

- Polar White
MAG61020-PWT
114.0710.363
\$665
- Stone Grey
MAG61020-SHG
114.0710.364
\$665
- NEW** Slate Grey
MAG61020-SLG
114.0713.080
\$665
- Onyx
MAG61020-ONY
114.0710.360
\$665
- Matte Black
MAG61020-MBK
114.0710.353
\$665
- Champagne
MAG61020-CHA
114.0710.351
\$665
- Oyster
MAG61020-OYS
114.0710.362
\$665
- Mocha
MAG61020-MOC
114.0710.359
\$665

MARIS



MAG61015
\$655

Interior Dimensions: 15⁷/₁₆" x 15³/₄" x 7⁷/₈"
Exterior Dimensions: 17⁵/₁₆" x 19¹¹/₁₆"
Minimum Cabinet Size: 18" (topmount) 21" (undermount)
Weight: 22 lbs.
Corner Radius: 20mm
Installation: Dual Mount
Pre-scored Faucet Hole: 1 to 3

Accessories Optional

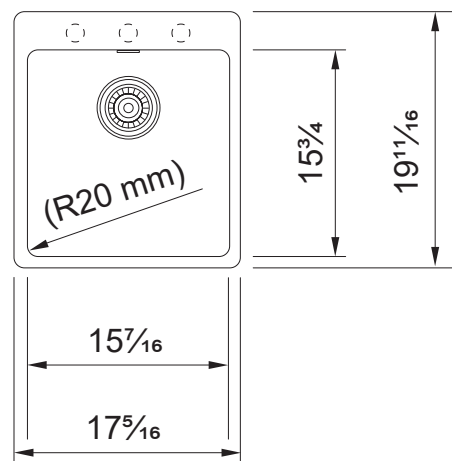

- Polar White
MAG61015-PWT
114.0687.062
\$655
- Stone Grey
MAG61015-SHG
114.0687.063
\$655
- NEW** Slate Grey
MAG61015-SLG
114.0713.090
\$655
- Onyx
MAG61015-ONY
114.0687.060
\$655
- Matte Black
MAG61015-MBK
114.0687.058
\$655
- Champagne
MAG61015-CHA
114.0687.057
\$655
- Oyster
MAG61015-OYS
114.0687.061
\$655
- Mocha
MAG61015-MOC
114.0687.059
\$655

ACCESSORIES OPTIONAL

- | | | | | | |
|--|---|--|---|--|---|
| <p>O1 Bottom Grid
13³/₈" x 15¹/₂"
Stainless
MA-15-36S
112.0687.993
\$210</p> | <p>O2 Bottom Grid
18⁷/₁₆" x 14"
Stainless
MA-20-36S
112.0709.442
\$245</p> | <p>O3 Colander
6¹/₂" x 16"
Stainless
MAC-70S
112.0688.103
\$255</p> | <p>O4 Colander
6¹/₂" x 17⁵/₁₆" x 2¹/₈"
Stainless
PX-70S
112.0066.060
\$280</p> | <p>O5 Cutting Board
11¹/₂" x 16"
Maple
MAC-40S
112.0688.104
\$225</p> | <p>O6 Cutting Board
11¹/₂" x 18"
Maple
MA2-40S
112.0688.102
\$225</p> |
| <p>O7 Roller Mat
11³/₄" x 16¹/₂"
Stainless
PKG14-31RM
112.0256.867
\$175</p> | <p>O8 Roller Mat
18³/₁₆" x 17¹/₁₆"
Stainless
MA2-31RM
112.0080.355
\$190</p> | <p>O9 Universal Roller Mat
18¹/₁₆" x 20"
Stainless
UV-36RM
112.0391.220
\$225</p> | <p>O10 Strainer Basket
Chrome
1145
112.0055.508
\$80
Satin Nickel
1145SN
112.0185.195
\$115</p> | <p>O11 Colorline Strainer Basket
900-PWT
900-SHG
900-SLG
900-MBK
900-CHA
900-OYS
900-MOC
\$100
Color shown is Champagne</p> | <p>O12 Colorline Disposer Flange Kit
WD-900-PWT
WD-900-SHG
WD-900-SLG
WD-900-MBK
WD-900-CHA
WD-900-OYS
WD-900-MOC
\$115
Color shown is Matte Black</p> |
| <p>O13 Colorline Drain Cover
4¹/₂"
RNDCVR-PWT
RNDCVR-SHG
RNDCVR-SLG
RNDCVR-MBK
RNDCVR-CHA
RNDCVR-OYS
RNDCVR-MOC
\$65
RNDCVR
Stainless
112.0532.169
\$120
Color shown is Stainless</p> | | | | | |

MARIS



MAG61023
\$670

Interior Dimensions: 23½" x 16⅞" x 9½"
Exterior Dimensions: 25" x 22"
Minimum Cabinet Size: 27"
Weight: 35 lbs.
Corner Radius: 16mm
Installation: Topmount
Pre-scored Faucet Hole: 1 to 5

Accessories Optional
O1 O5 O7 O11 O12 O13 O14 O15

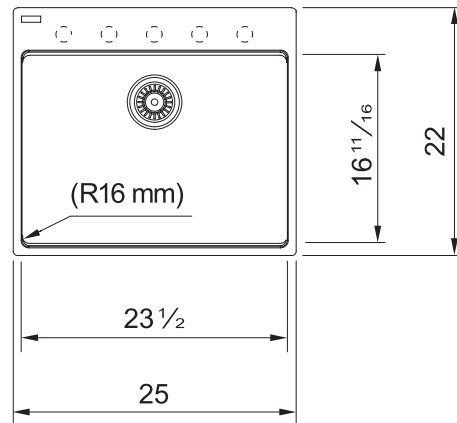

-  Polar White
MAG61023-PWT
114.0687.048
\$670
-  Stone Grey
MAG61023-SHG
114.0687.049
\$670
- NEW**  Slate Grey
MAG61023-SLG
114.0713.084
\$670
-  Onyx
MAG61023-ONY
114.0687.046
\$670
-  Matte Black
MAG61023-MBK
114.0687.044
\$670
-  Champagne
MAG61023-CHA
114.0687.043
\$670
-  Oyster
MAG61023-OYS
114.0687.047
\$670
-  Mocha
MAG61023-MOC
114.0687.045
\$670

Maris

MARIS









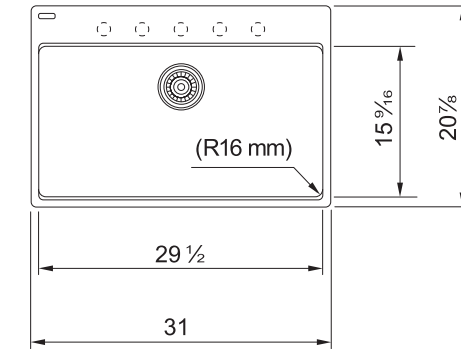

MAG61029
\$725

Interior Dimensions: 29½" x 15⅞" x 9½"
Exterior Dimensions: 31" x 20⅞"
Minimum Cabinet Size: 33"
Weight: 37 lbs.
Corner Radius: 16mm
Installation: Topmount
Pre-scored Faucet Hole: 1 to 5

Accessories Optional
O2 O4 O6 O10 O12 O13 O14 O15



-  Polar White
MAG61029-PWT
114.0687.104
\$725
-  Stone Grey
MAG61029-SHG
114.0687.105
\$725
- NEW**  Slate Grey
MAG61029-SLG
114.0713.086
\$725
-  Onyx
MAG61029-ONY
114.0687.102
\$725
-  Matte Black
MAG61029-MBK
114.0687.100
\$725
-  Champagne
MAG61029-CHA
114.0687.099
\$725
-  Oyster
MAG61029-OYS
114.0687.103
\$725
-  Mocha
MAG61029-MOC
114.0687.101
\$725

MARIS



Laundry Sink







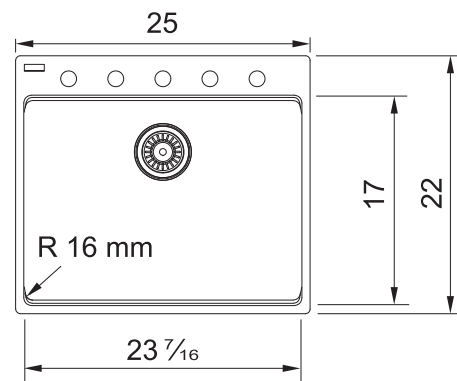

MAG61023L
\$750













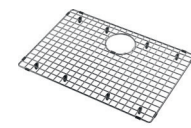
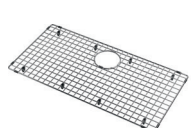



Interior Dimensions: 23⅞" x 17" x 12"
Exterior Dimensions: 25" x 22"
Minimum Cabinet Size: 27" (topmount)
30" (undermount)
Weight: 35 lbs.
Corner Radius: 16mm
Installation: Dual Mount
Pre-scored Faucet Hole: 1 to 5

Accessories Optional
O3 O8 O9 O12 O13 O14 O15



-  Polar White
MAG61023L-PWT
114.0637.874
\$750
-  Stone Grey
MAG61023L-SHG
114.0637.873
\$750
- NEW**  Slate Grey
MAG61023L-SLG
114.0713.076
\$750
-  Onyx
MAG61023L-ONY
114.0637.872
\$750
-  Matte Black
MAG61023L-MBK
114.0637.878
\$750
-  Champagne
MAG61023L-CHA
114.0637.877
\$750
-  Oyster
MAG61023L-OYS
114.0637.876
\$750
-  Mocha
MAG61023L-MOC
114.0688.139
\$750

ACCESSORIES OPTIONAL

- | | | | | | |
|--|---|--|---|---|--|
| 
O1 Bottom Grid
21⅞" x 15⅞"
Stainless
MA-23-36S
112.0687.977
\$255 | 
O2 Bottom Grid
27⅞" x 14"
Stainless
MA-29-36S
112.0687.980
\$295 | 
O3 Colander
6⅞" x 17⅞" x 2⅞"
Stainless
PE-70S
112.0334.171
\$290 | 
O4 Colander
6⅞" x 16"
Stainless
MAC-70S
112.0688.103
\$255 | 
O5 Colander
6⅞" x 17⅞" x 2⅞"
Stainless
PX-70S
112.0066.060
\$280 | 
O6 Cutting Board
11⅞" x 16⅞"
Maple
MAC-40S
112.0688.104
\$225 |
| 
O7 Cutting Board
11⅞" x 18"
Maple
MA2-40S
112.0688.102
\$225 | 
O8 Cutting Board
11⅞" x 18⅞"
Maple
MA3-40S
112.0643.597
\$225 | 
O9 Utility Roller Mat
18⅞" x 17⅞"
Stainless
MA-17-31LRM
112.0643.576
\$190 | 
O10 Roller Mat
11⅞" x 16⅞"
Stainless
PKG14-31RM
112.0256.867
\$175 | 
O11 Roller Mat
18⅞" x 17⅞"
Stainless
MA2-31RM
112.0080.355
\$190 | 
O12 Strainer Basket
Chrome
1145
112.0055.508
\$80
Satin Nickel
1145SN
112.0185.195
\$115 |
| 
O13 Colorline Strainer Basket
900-PWT
900-SHG
900-SLG
900-MBK
900-CHA
900-OYS
900-MOC
\$100
Color shown is Champagne | 
O14 Colorline Disposer Flange Kit
WD-900-PWT
WD-900-SHG
WD-900-SLG
WD-900-MBK
WD-900-CHA
WD-900-OYS
WD-900-MOC
\$115
Color shown is Matte Black | 
O15 Colorline Drain Cover
4⅞"
RNDCVR-PWT
RNDCVR-SHG
RNDCVR-SLG
RNDCVR-MBK
RNDCVR-CHA
RNDCVR-OYS
RNDCVR-MOC
\$65
RNDCVR
Stainless
112.0532.169
\$120
Color shown is Stainless | 
Active
Matte Black
ACT-PO-MBK
115.0656.848
\$855 | | |

Note: All accessories sold separately unless otherwise indicated. Design of custom accessories subject to change without notice. It is absolutely critical that you have the sink and any custom sink accessories on-site prior to any cut or modification to the countertop. Franke will not be responsible for any errors in countertop preparation and sink installation.

Maris



MAG61031
\$750

Interior Dimensions: 31½" x 16¹¹/₁₆" x 9½"
Exterior Dimensions: 33" x 22"
Minimum Cabinet Size: 36"
Weight: 39 lbs.
Corner Radius: 16mm
Installation: Topmount
Pre-scored Faucet Hole: 1 to 5

Accessories Optional
O4 O5 O8 O12 O14 O15 O16 O17

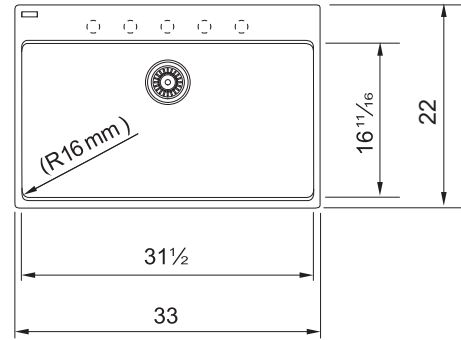

- Polar White
MAG61031-PWT
114.0686.985
\$750
- Stone Grey
MAG61031-SHG
114.0686.986
\$750
- Slate Grey
MAG61031-SLG
114.0713.088
\$750
- Onyx
MAG61031-ONY
114.0686.983
\$750
- Matte Black
MAG61031-MBK
114.0686.981
\$750
- Champagne
MAG61031-CHA
114.0686.940
\$750
- Oyster
MAG61031-OYS
114.0686.984
\$750
- Mocha
MAG61031-MOC
114.0686.982
\$750



MAG61031OW
\$750

Interior Dimensions: 31⁷/₁₆" x 17" x 9½"
Exterior Dimensions: 33" x 22"
Minimum Cabinet Size: 36"
Weight: 40 lbs.
Corner Radius: 16mm
Installation: Topmount
Pre-scored Faucet Hole: 1 to 6

Accessories Optional
O1 O6 O9 O11 O14 O15 O16 O17

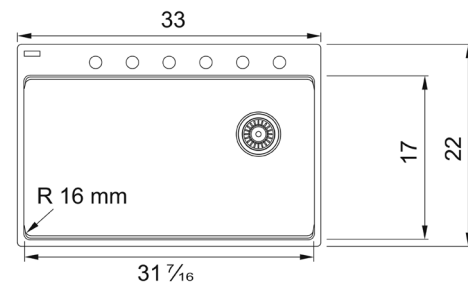

- Polar White
MAG61031OW-PWT
114.0637.881
\$750
- Stone Grey
MAG61031OW-SHG
114.0637.880
\$750
- Slate Grey
MAG61031OW-SLG
114.0713.078
\$750
- Onyx
MAG61031OW-ONY
114.0637.879
\$750
- Matte Black
MAG61031OW-MBK
114.0637.885
\$750
- Champagne
MAG61031OW-CHA
114.0637.884
\$750
- Oyster
MAG61031OW-OYS
114.0637.883
\$750
- Mocha
MAG61031OW-MOC
114.0688.138
\$750

Maris



Low Divide Sink

MAG6601611LD
\$770

Interior Dimensions: 29½" x 15⁹/₁₆" x 9½"
Exterior Dimensions: 31" x 20⁷/₈"
Minimum Cabinet Size: 33"
Weight: 39 lbs.
Corner Radius: 16mm
Installation: Topmount
Pre-scored Faucet Hole: 1 to 5

Accessories Optional
O2 O3 O7 O10 O13 O14 O15 O16 O17

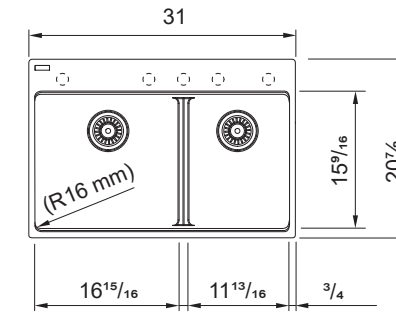

- Polar White
MAG6601611LD-PWT
114.0687.090
\$770
- Stone Grey
MAG6601611LD-SHG
114.0687.091
\$770
- Slate Grey
MAG6601611LD-SLG
114.0713.096
\$770
- Onyx
MAG6601611LD-ONY
114.0687.088
\$770
- Matte Black
MAG6601611LD-MBK
114.0687.086
\$770
- Champagne
MAG6601611LD-CHA
114.0687.085
\$770
- Oyster
MAG6601611LD-OYS
114.0687.089
\$770
- Mocha
MAG6601611LD-MOC
114.0687.087
\$770

ACCESSORIES OPTIONAL

- | | | | | | |
|---|--|--|---|--|---|
| <p>O1 Bottom/ Shelf Grid
(Left) 14³/₈" x 15¹/₈"
(Right) 14³/₈" x 15¹/₈"
Stainless
MA-16-36S
112.0687.994
\$225</p> | <p>O2 Bottom Grid
15¹/₈" x 14"
Stainless
MA-16-36S
112.0687.994
\$225</p> | <p>O3 Bottom Grid
10³/₈" x 14"
Stainless
MA-11-36S
112.0687.995
\$180</p> | <p>O4 Bottom/ Shelf Grid
29³/₁₆" x 15¹/₈"
Stainless
MA2-31-36S
112.0687.991
\$310</p> | <p>O5 Colander
6¹/₂" x 17⁷/₁₆" x 2¹/₂"
Stainless
PX-70S
112.0066.060
\$280</p> | <p>O6 Colander
6¹/₂" x 17⁷/₁₆" x 2¹/₂"
Stainless
PE-70S
112.0334.171
\$290</p> |
| <p>O7 Colander
6¹/₂" x 16"
Stainless
MAC-70S
112.0688.103
\$255</p> | <p>O8 Cutting Board
11³/₈" x 18"
Maple
MA2-40S
112.0688.102
\$225</p> | <p>O9 Cutting Board
11³/₈" x 18³/₈"
Maple
MA3-40S
112.0643.597
\$225</p> | <p>O10 Cutting Board
11³/₈" x 16³/₈"
Maple
MAC-40S
112.0688.104
\$225</p> | <p>O11 Roller Mat
18⁷/₁₆" x 17¹/₁₆"
Stainless
MA-31RM
112.0643.591
\$190</p> | <p>O12 Roller Mat
18⁷/₁₆" x 17¹/₁₆"
Stainless
MA2-31RM
112.0080.355
\$190</p> |
| <p>O13 Roller Mat
11³/₈" x 16³/₈"
Stainless
PKG14-31RM
112.0256.867
\$175</p> | <p>O14 Strainer Basket
Chrome
1145
112.0055.508
\$80</p> | <p>O15 Colorline Strainer Basket
900-PWT
900-SHG
900-SLG
900-MBK
900-CHA
900-OYS
900-MOC
\$100
Color shown is Champagne</p> | <p>O16 Colorline Disposer Flange Kit
WD-900-PWT
WD-900-SHG
WD-900-SLG
WD-900-MBK
WD-900-CHA
WD-900-OYS
WD-900-MOC
\$115
Color shown is Matte Black</p> | <p>O17 Colorline Drain Cover
4¹/₂"
RNDCVR-PWT
RNDCVR-SHG
RNDCVR-SLG
RNDCVR-MBK
RNDCVR-CHA
RNDCVR-OYS
RNDCVR-MOC
\$65
RNDCVR
Stainless
112.0532.169
\$120
Color shown is Stainless</p> | <p>Active
Matte Black
ACT-PO-MBK
115.0656.848
\$855</p> |

Maris



MAG6201414
\$770

Interior Dimensions: 29½" x 15⅞" x 9½"
Exterior Dimensions: 31" x 20⅞"
Minimum Cabinet Size: 33"
Weight: 42 lbs.
Corner Radius: 16mm
Installation: Topmount
Pre-scored Faucet Hole: 1 to 7

Accessories Optional

- O3
- O5
- O7
- O9
- O11
- O12
- O13
- O14

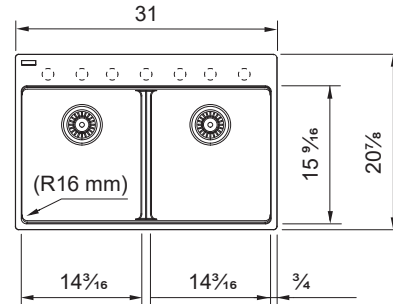

- Polar White
MAG6201414-PWT
114.0687.076
\$770
- Stone Grey
MAG6201414-SHG
114.0687.077
\$770
- NEW** Slate Grey
MAG6201414-SLG
114.0713.092
\$770
- Onyx
MAG6201414-ONY
114.0687.074
\$770
- Matte Black
MAG6201414-MBK
114.0687.072
\$770
- Champagne
MAG6201414-CHA
114.0687.071
\$770
- Oyster
MAG6201414-OYS
114.0687.075
\$770
- Mocha
MAG6201414-MOC
114.0687.073
\$770



MAG6601812LD
\$800

Low Divide Sink

Interior Dimensions: 31½" x 16⅞" x 9½"
Exterior Dimensions: 33" x 22"
Minimum Cabinet Size: 36"
Weight: 42 lbs.
Corner Radius: 16mm
Installation: Topmount
Pre-scored Faucet Hole: 1 to 5

Accessories Optional

- O1
- O2
- O6
- O8
- O10
- O11
- O12
- O13
- O14

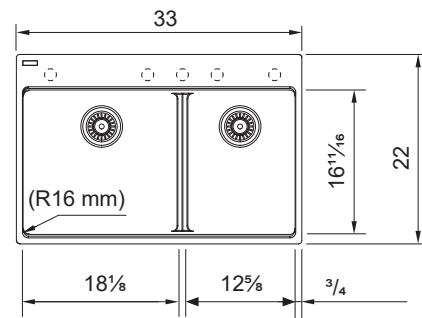

- Polar White
MAG6601812LD-PWT
114.0687.013
\$800
- Stone Grey
MAG6601812LD-SHG
114.0687.014
\$800
- NEW** Slate Grey
MAG6601812LD-SLG
114.0713.098
\$800
- Onyx
MAG6601812LD-ONY
114.0687.011
\$800
- Matte Black
MAG6601812LD-MBK
114.0687.009
\$800
- Champagne
MAG6601812LD-CHA
114.0687.008
\$800
- Oyster
MAG6601812LD-OYS
114.0687.012
\$800
- Mocha
MAG6601812LD-MOC
114.0687.010
\$800

Maris



MAG6201515
\$800

Interior Dimensions: 31½" x 16⅞" x 9½"
Exterior Dimensions: 33" x 22"
Minimum Cabinet Size: 36"
Weight: 43 lbs.
Corner Radius: 16mm
Installation: Topmount
Pre-scored Faucet Hole: 1 to 7





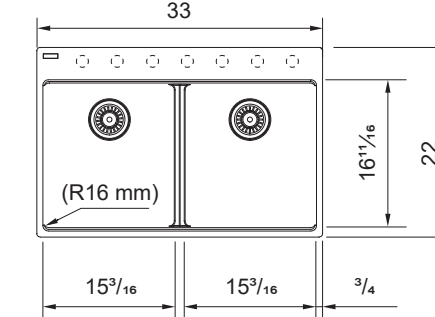





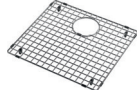

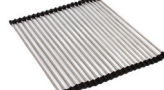
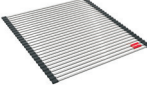

Accessories Optional

- O4
- O6
- O8
- O10
- O11
- O12
- O13
- O14



- Polar White
MAG6201515-PWT
114.0686.999
\$800
- Stone Grey
MAG6201515-SHG
114.0687.000
\$800
- NEW** Slate Grey
MAG6201515-SLG
114.0713.094
\$800
- Onyx
MAG6201515-ONY
114.0686.997
\$800
- Matte Black
MAG6201515-MBK
114.0686.995
\$800
- Champagne
MAG6201515-CHA
114.0686.994
\$800
- Oyster
MAG6201515-OYS
114.0686.998
\$800
- Mocha
MAG6201515-MOC
114.0686.996
\$800

ACCESSORIES OPTIONAL

-  **O1 Bottom Grid**
16⅞" x 15⅞"
Stainless
MA-18-36S
112.0687.996
\$235
-  **O2 Bottom Grid**
11⅞" x 15⅞"
Stainless
MA-12-36S
112.0687.997
\$190
-  **O3 Bottom Grid**
12⅞" x 14"
Stainless
MA-14-36S
112.0687.992
\$200
-  **O4 Bottom Grid**
13⅞" x 15⅞"
Stainless
MA-15-36S
112.0687.993
\$210
-  **O5 Roller Mat**
11⅞" x 16⅞"
Stainless
PKG14-31RM
112.0256.867
\$175
-  **O6 Roller Mat**
18⅞" x 17⅞"
Stainless
MA2-31RM
112.0080.355
\$190
-  **O7 Colander**
6⅞" x 16"
Stainless
MAC-70S
112.0688.103
\$255
-  **O8 Colander**
6⅞" x 17⅞" x 2⅞"
Stainless
PX-70S
112.0066.060
\$280
-  **O9 Cutting Board**
11⅞" x 16⅞"
Maple
MAC-40S
112.0688.104
\$225
-  **O10 Maple Cutting Board**
11⅞" x 18"
Solid Wood
MA2-40S
112.0688.102
\$225
-  **O11 Strainer Basket**
Chrome
1145
112.0055.508
\$80
-  **O12 Colorline Strainer Basket**
900-PWT
900-SHG
900-SLG
900-MBK
900-CHA
900-OYS
900-MOC
\$100
Color shown is Champagne
-  **O13 Colorline Disposer Flange Kit**
WD-900-PWT
WD-900-SHG
WD-900-SLG
WD-900-MBK
WD-900-CHA
WD-900-OYS
WD-900-MOC
\$115
Color shown is Matte Black
-  **O14 Colorline Drain Cover**
4½"
RNDCVR-PWT
RNDCVR-SHG
RNDCVR-SLG
RNDCVR-MBK
RNDCVR-CHA
RNDCVR-OYS
RNDCVR-MOC
\$65
RNDCVR
Stainless
112.0532.169
\$120
Color shown is Stainless
-  **Active**
Matte Black
ACT-PO-MBK
115.0656.848
\$855

Maris ADA



MAG11023ADA
\$695

Interior Dimensions: 23⁷/₁₆" x 16¹¹/₁₆" x 5"
Exterior Dimensions: 25" x 18¹⁵/₁₆"
Minimum Cabinet Size: 30"
Weight: 32 lbs.
Corner Radius: 16mm
Installation: Undermount

Accessories Optional

- O1
- O2
- O3
- O4
- O5
- O6
- O7
- O8

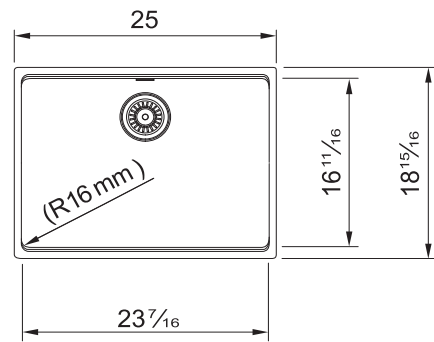

- Polar White
MAG11023ADA-PWT
125.0687.041
\$695
- Stone Grey
MAG11023ADA-SHG
125.0687.042
\$695
- NEW** Slate Grey
MAG11023ADA-SLG
125.0713.104
\$695
- Onyx
MAG11023ADA-ONY
125.0687.039
\$695
- Matte Black
MAG11023ADA-MBK
125.0687.037
\$695
- Champagne
MAG11023ADA-CHA
125.0687.036
\$695
- Oyster
MAG11023ADA-OYS
125.0687.040
\$695
- Mocha
MAG11023ADA-MOC
125.0687.038
\$695

ACCESSORIES OPTIONAL

- 

O1 Bottom Grid
22³/₁₆" x 15³/₁₆"
Stainless
MAA-23-36S
112.0687.998
\$255
- 

O2 Colander
6¹/₂" x 17⁵/₁₆" x 2¹/₂"
Stainless
PX-70S
112.0066.060
\$280
- 

O3 Cutting Board
11" x 18"
Maple
MA2-40S
112.0688.102
\$225
- 

O4 Roller Mat
18⁷/₁₆" x 17³/₁₆"
Stainless
MA2-31RM
112.0080.355
\$190
- 

O5 Strainer Basket
Chrome
1145
112.0055.508
\$80
Satin Nickel
1145SN
112.0185.195
\$115
- 

O6 Colorline Strainer Basket
900-PWT
900-SHG
900-SLG
900-MBK
900-CHA
900-OYS
900-MOC
\$100
Color shown is Champagne
- 

O7 Colorline Disposer Flange Kit
WD-900-PWT
WD-900-SHG
WD-900-SLG
WD-900-MBK
WD-900-CHA
WD-900-OYS
WD-900-MOC
\$115
Color shown is Matte Black
- 

O8 Colorline Drain Cover
4¹/₂"
RNDCVR-PWT
RNDCVR-SHG
RNDCVR-SLG
RNDCVR-MBK
RNDCVR-CHA
RNDCVR-OYS
RNDCVR-MOC
\$65
RNDCVR
Stainless
112.0532.169
\$120
Color shown is Stainless
- 

Active
Matte Black
ACT-PO-MBK
115.0656.848
\$855



MAG61023ADA
\$670

Interior Dimensions: 23¹/₂" x 16¹¹/₁₆" x 5"
Exterior Dimensions: 25" x 22"
Minimum Cabinet Size: 27"
Weight: 34 lbs.
Corner Radius: 16mm
Installation: Topmount
Pre-scored Faucet Hole: 1 to 5

Accessories Optional

- O1
- O2
- O3
- O4
- O5
- O6
- O7
- O8

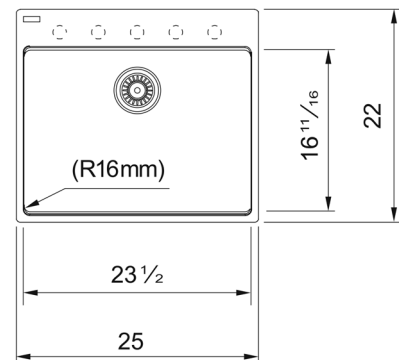

- Polar White
MAG61023ADA-PWT
114.0687.055
\$670
- Stone Grey
MAG61023ADA-SHG
114.0687.056
\$670
- NEW** Slate Grey
MAG61023ADA-SLG
114.0713.082
\$670
- Onyx
MAG61023ADA-ONY
114.0687.053
\$670
- Matte Black
MAG61023ADA-MBK
114.0687.051
\$670
- Champagne
MAG61023ADA-CHA
114.0687.050
\$670
- Oyster
MAG61023ADA-OYS
114.0687.054
\$670
- Mocha
MAG61023ADA-MOC
114.0687.052
\$670

Workcenters

Optimize every inch of your sink.



Elevate your space

Today the most important kitchen accessories become part of the sink and accessible all the time. The granite workcenter sink and accessories create a unique kitchen solution for people who demand efficiency and optimum use of space.



Optimize efficiency

The purpose of the Workcenter is to support functions in the kitchen by offering an additional workspace and freeing up counter space.



Multi-functional workspace

Space-saving integrated kitchen tools offer plenty of room for prepping over your sink, freeing up counter space for other cooking activities.

Made to handle everyday tasks

Able to withstand temperatures up to 536°F to protect against thermal shock, discoloration and cracks from hot pots and pans. Scratch and stain resistant Maris granite sinks are engineered to perform.



Peak



MYTHOS



PKG11031-WKC
\$1,605

Interior Dimensions: 31" x 17 $\frac{3}{4}$ " x 9 $\frac{1}{2}$ "
Exterior Dimensions: 32" x 18 $\frac{3}{4}$ "
Minimum Cabinet Size: 36"
Weight: 45 lbs.
Corner Radius: 10mm
Installation: Undermount

Accessories Included

A1 A2 A3 A4 A5

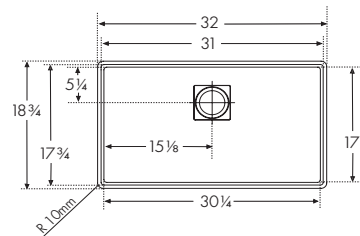

ACCESSORIES INCLUDED

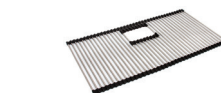

A1 Bottom Roller Mat
25 $\frac{3}{4}$ " x 13 $\frac{3}{4}$ "
Stainless
PKG31-36RM
112.0391.216
\$280

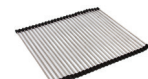

A2 Shelf Roller Mat
18 $\frac{1}{16}$ " x 16 $\frac{3}{16}$ "
Stainless
PKG18-31RM
112.0391.218
\$210



A3 Cutting Board
14 $\frac{1}{2}$ " x 18 $\frac{3}{4}$ "
Solid Wood
PG-40S
112.0434.912
\$290



A4 Strainer Basket
Chrome
1145
112.0055.508
\$80



A5 Drain Cover
Stainless
PKGCVR
112.0395.171
\$120

- Polar White
PKG11031PWT-WKC
125.0672.240
\$1,605
- Stone Grey
PKG11031SHG-WKC
125.0672.241
\$1,605
- NEW** Slate Grey
PKG11031SLG-WKC
125.0715.371
\$1,605
- Onyx
PKG11031ONY-WKC
125.0672.232
\$1,605
- Matte Black
PKG11031MBK-WKC
125.0672.235
\$1,605
- Champagne
PKG11031CHA-WKC
125.0672.234
\$1,605
- Oyster
PKG11031OYS-WKC
125.0672.237
\$1,605
- Mocha
PKG11031MOC-WKC
125.0672.236
\$1,605

Maris



MARIS



MAG11031OW-WKC
\$1,420

Interior Dimensions: 31 $\frac{1}{16}$ " x 17" x 9 $\frac{1}{2}$ "
Exterior Dimensions: 33" x 19 $\frac{1}{16}$ "
Minimum Cabinet Size: 36"
Weight: 45 lbs.
Corner Radius: 16mm
Installation: Undermount

Accessories Included

A1 A2 A3 A4

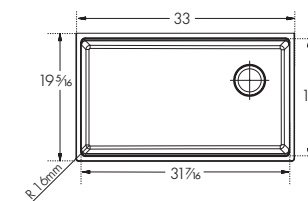

ACCESSORIES INCLUDED

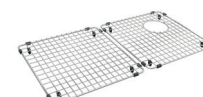

A1 Bottom Grid
(Left) 14 $\frac{1}{2}$ " x 15 $\frac{1}{16}$ "
(Right) 14 $\frac{1}{2}$ " x 15 $\frac{1}{16}$ "
Stainless
MA-31-36S
112.0643.593
\$310



A2 Colander
6 $\frac{1}{2}$ " x 17 $\frac{1}{32}$ "
Stainless
PE-70S
112.0334.171
\$290



A3 Cutting Board
11 $\frac{1}{8}$ " x 18 $\frac{1}{8}$ "
Solid Wood
MA3-40S
112.0643.597
\$225



A4 Strainer Basket
Chrome
1145
112.0055.508
\$80

- Polar White
MAG11031OW-PWT-WKC
125.0672.247
\$1,420
- Stone Grey
MAG11031OW-SHG-WKC
125.0672.248
\$1,420
- NEW** Slate Grey
MAG11031OW-SLG-WKC
125.0715.372
\$1,420
- Onyx
MAG11031OW-ONY-WKC
125.0672.243
\$1,420
- Matte Black
MAG11031OW-MBK-WKC
125.0672.245
\$1,420
- Champagne
MAG11031OW-CHA-WKC
125.0672.244
\$1,420
- Oyster
MAG11031OW-OYS-WKC
125.0672.246
\$1,420
- Mocha
MAG11031OW-MOC-WKC
125.0688.140
\$1,420

Peak

Flawless features.



Precise and elegant in style, this premium range of sinks will complement those with a flair for contemporary and minimalist design. With a tighter 10 mm sink corner radius and a flush drain cover, Peak is sure to integrate seamlessly into your kitchen area and bring everything a modern cook requires: attention to detail and absolute elegance.



A place for everything

Our Sanitized® Technology makes your sink bacteria resistant — an added plus for busy kitchens and active families.



Versatile workspace

The roller mat offers a wealth of uses for rinsing produce or drying dishes. It can also be used as a trivet for hot cookware or as a plating area.

Optimize every inch of your sink

This intelligent workcenter system provides all the essentials needed for food prep or impromptu meals. It was designed for multitasking and seamlessly blends into the most active area in the house: the kitchen.



MYTHOS



PKG11014
\$675

Interior Dimensions: 14⁹/₁₆" x 16¹/₂" x 7⁷/₈"
Exterior Dimensions: 16¹/₈" x 18¹/₈"
Minimum Cabinet Size: 18"
Weight: 20 lbs.
Integral Franke Ledge System
Corner Radius: 10mm
Installation: Undermount

Accessories Optional





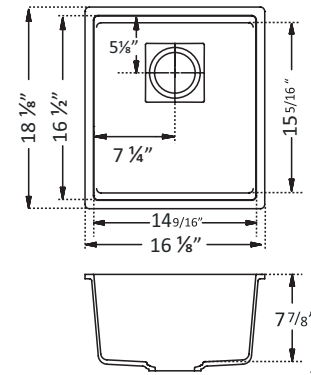

O1 O5 O7 O8 O9

Accessories Included

A1



Peak

-  Polar White
PKG11014PWT
125.0641.520
\$675
-  Stone Grey
PKG11014SHG
125.0507.824
\$675
- NEW**  Slate Grey
PKG11014SLG
125.0713.126
\$675
-  Onyx
PKG11014ONY
125.0507.789
\$675
-  Matte Black
PKG11014MBK
125.0637.086
\$675
-  Champagne
PKG11014CHA
125.0507.547
\$675
-  Oyster
PKG11014OYS
125.0507.821
\$675
-  Mocha
PKG11014MOC
125.0507.786
\$675

MYTHOS

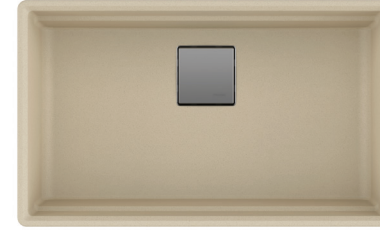

PKG11031
\$955

Interior Dimensions: 31" x 17³/₄" x 9¹/₂"
Exterior Dimensions: 32" x 18³/₄"
Minimum Cabinet Size: 36"
Weight: 38 lbs.
Integral Franke Ledge System
Corner Radius: 10mm
Installation: Undermount







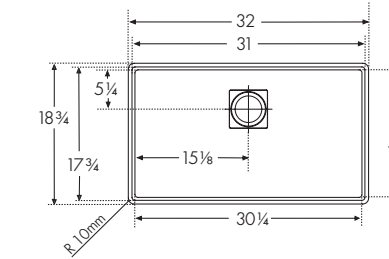

Accessories Optional

O3 O4 O6 O7 O8 O9

Accessories Included

A1



-  Polar White
PKG11031PWT
125.0641.510
\$955
-  Stone Grey
PKG11031SHG
125.0491.545
\$955
- NEW**  Slate Grey
PKG11031SLG
125.0713.124
\$955
-  Onyx
PKG11031ONY
125.0389.567
\$955
-  Matte Black
PKG11031MBK
125.0637.090
\$955
-  Champagne
PKG11031CHA
125.0389.570
\$955
-  Oyster
PKG11031OYS
125.0389.569
\$955
-  Mocha
PKG11031MOC
125.0390.397
\$955

Peak

MYTHOS



PKG11020
\$815

Interior Dimensions: 20⁷/₁₆" x 16¹/₂" x 7⁷/₈"
Exterior Dimensions: 22¹/₁₆" x 18¹/₈"
Minimum Cabinet Size: 27"
Weight: 24 lbs.
Integral Franke Ledge System
Corner Radius: 10mm
Installation: Undermount







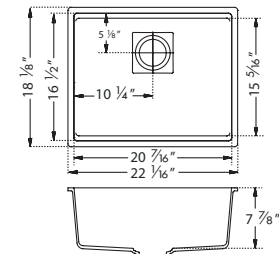

Accessories Optional

O2 O5 O7 O8 O9

Accessories Included

A1



-  Polar White
PKG11020PWT
125.0641.521
\$815
-  Stone Grey
PKG11020SHG
125.0507.835
\$815
- NEW**  Slate Grey
PKG11020SLG
125.0713.128
\$815
-  Onyx
PKG11020ONY
125.0507.831
\$815
-  Matte Black
PKG11020MBK
125.0637.088
\$815
-  Champagne
PKG11020CHA
125.0507.827
\$815
-  Oyster
PKG11020OYS
125.0507.832
\$815
-  Mocha
PKG11020MOC
125.0507.828
\$815

ACCESSORIES OPTIONAL

-  **O1 Bottom Roller Mat**
11¹/₁₆" x 13¹/₂"
Stainless
PKG14-36RM
112.0594.070
\$220
-  **O2 Bottom Roller Mat**
17³/₄" x 13¹/₂"
Stainless
PKG20-36RM
112.0594.141
\$245
-  **O3 Bottom Roller Mat**
25³/₄" x 13¹/₂"
Stainless
PKG31-36RM
112.0391.216
\$280
-  **O4 Shelf Roller Mat**
18⁷/₁₆" x 16¹/₁₆"
Stainless
PKG18-31RM
112.0391.218
\$210
-  **O5 Roller Mat**
11¹/₄" x 16¹/₈"
Stainless
PKG14-31RM
112.0256.867
\$175
-  **O6 Cutting Board**
14¹/₂" x 18¹/₈"
Solid Wood
PG-40S
112.0434.912
\$290
-  **O7 Colorline Strainer Basket**
900-PWT
900-SHG
900-SLG
900-MBK
900-CHA
900-OYS
900-MOC
\$100
Color shown is Champagne
-  **O8 Colorline Disposer Flange Kit**
WD-900-PWT
WD-900-SHG
WD-900-SLG
WD-900-MBK
WD-900-CHA
WD-900-OYS
WD-900-MOC
\$115
Color shown is Matte Black
-  **O9 Strainer Basket**
Chrome
1145
112.0055.508
\$80
Satin Nickel
1145SN
112.0185.195
\$115
-  **A1 Drain Cover**
4⁷/₈" x 4⁷/₈"
Stainless
PKGCVR
112.0395.171
\$120
One included
-  **Icon**
Matte Black
ICN-PO-MBK
115.0690.401
\$1,260

Peak



PKG11031-WKC
\$1,605

Interior Dimensions: 31" x 17³/₄" x 9¹/₂"
Exterior Dimensions: 32" x 18³/₄"
Minimum Cabinet Size: 36"
Weight: 45 lbs.
Integral Franke Ledge System
Corner Radius: 10mm
Installation: Undermount

Accessories Included

- A1
- A2
- A3
- A4
- A5

Accessories Optional

- O1
- O2

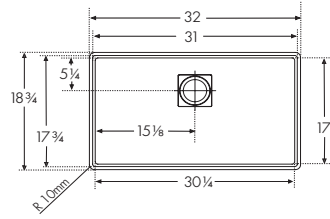

- Polar White
PKG11031PWT-WKC
125.0672.240
\$1,605
- Stone Grey
PKG11031SHG-WKC
125.0672.241
\$1,605
- NEW** Slate Grey
PKG11031SLG-WKC
125.0715.371
\$1,605
- Onyx
PKG11031ONY-WKC
125.0672.232
\$1,605
- Matte Black
PKG11031MBK-WKC
125.0672.235
\$1,605
- Champagne
PKG11031CHA-WKC
125.0672.234
\$1,605
- Oyster
PKG11031OYS-WKC
125.0672.237
\$1,605
- Mocha
PKG11031MOC-WKC
125.0672.236
\$1,605

ACCESSORIES INCLUDED

- A1 Bottom Roller Mat**
25³/₄" x 13³/₄"
Stainless
PKG31-36RM
112.0391.216
\$280
Included
- A2 Shelf Roller Mat**
18⁷/₁₆" x 16⁷/₁₆"
Stainless
PKG18-31RM
112.0391.218
\$210
Included
- A3 Cutting Board**
14³/₈" x 18³/₈"
Solid Wood
PG-40S
112.0434.912
\$290
Included
- A4 Strainer Basket**
Chrome
1145
112.0055.508
\$80
Included
- A5 Drain Cover**
4⁷/₈" x 4⁷/₈"
Stainless
PKGCVR
112.0395.171
\$120
One included

ACCESSORIES OPTIONAL

- O1 Colorline Strainer Basket**
900-PWT
900-SHG
900-SLG
900-MBK
900-CHA
900-OYS
900-MOC
\$100
Color shown is Champagne
- O2 Colorline Disposer Flange Kit**
WD-900-PWT
WD-900-SHG
WD-900-SLG
WD-900-MBK
WD-900-CHA
WD-900-OYS
WD-900-MOC
\$115
Color shown is Matte Black
- Icon**
Matte Black
ICN-PO-MBK
115.0690.401
\$1,260
Optional

Peak



PKG160LD
\$1,035

Low Divide Sink

Interior Dimensions: 31" x 17³/₄" x 9¹/₂"
Exterior Dimensions: 32" x 18³/₄"
Minimum Cabinet Size: 36"
Weight: 40 lbs.
Integral Franke Ledge System
Corner Radius: 10mm
Installation: Undermount

Accessories Optional

- O1
- O2
- O3
- O4
- O5
- O6
- O7

Accessories Included

- A1

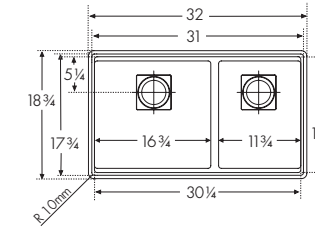

- Polar White
PKG160LD-PWT
125.0641.513
\$1,035
- Stone Grey
PKG160LD-SHG
125.0491.536
\$1,035
- NEW** Slate Grey
PKG160LD-SLG
125.0713.130
\$1,035
- Onyx
PKG160LD-ONY
125.0389.612
\$1,035
- Matte Black
PKG160LD-MBK
125.0637.092
\$1,035
- Champagne
PKG160LD-CHA
125.0389.616
\$1,035
- Oyster
PKG160LD-OYS
125.0389.615
\$1,035
- Mocha
PKG160LD-MOC
125.0389.613
\$1,035

ACCESSORIES OPTIONAL

- O1 Shelf Roller Mat**
18⁷/₁₆" x 16⁷/₁₆"
Stainless
PKG18-31RM
112.0391.218
\$210
- O2 Bottom Roller Mat**
15" x 13³/₄"
Stainless
PKG17-36RM
112.0391.212
\$225
- O3 Bottom Roller Mat**
9³/₄" x 13³/₄"
Stainless
PKG12-36RM
112.0391.214
\$180
- O4 Cutting Board**
14³/₈" x 18³/₈"
Solid Wood
PG-40S
112.0434.912
\$290
- O5 Colorline Strainer Basket**
900-PWT
900-SHG
900-SLG
900-MBK
900-CHA
900-OYS
900-MOC
\$100
Color shown is Champagne
- O6 Colorline Disposer Flange Kit**
WD-900-PWT
WD-900-SHG
WD-900-SLG
WD-900-MBK
WD-900-CHA
WD-900-OYS
WD-900-MOC
\$115
Color shown is Matte Black
- O7 Strainer Basket**
Chrome
1145
112.0055.508
\$80
Satin Nickel
1145SN
112.0185.195
\$115
- A1 Drain Cover**
4⁷/₈" x 4⁷/₈"
Stainless
PKGCVR
112.0395.171
\$120
Two included
- Icon**
Matte Black
ICN-PO-MBK
115.0690.401
\$1,260
Optional

Note: All accessories sold separately unless otherwise indicated. Design of custom accessories subject to change without notice. It is absolutely critical that you have the sink and any custom sink accessories on-site prior to any cut or modification to the countertop. Franke will not be responsible for any errors in countertop preparation and sink installation.

Ellipse

The perfect sink for families.



Available in several configurations, there's an Ellipse sink that's perfect for your space. Franke granite sinks are made from 80% quartz, the hardest component of granite, and bonded using high-quality acrylic resins for a sink that will serve you for years to come.



Versatile installation

Ellipse has installation options to suit any kitchen style, from a seamless-finish undermount to an easy-to-install topmount.

A natural beauty

The collection is offered in a variety of warm, sophisticated and enveloping shades, inspired by natural elements.



Easy to maintain

Franke granite sinks are resistant to temperatures up to 536° F and impact and thermal shock. They are also stain-resistant — even red wine will not leave a mark.

Always colorful

Thanks to UV protection, the granite's beautiful color will not fade, ensuring long-lasting use.

Ellipse



ELG11022
\$675

Interior Dimensions: 21⁷/₈" x 16⁷/₈" x 9"
Exterior Dimensions: 25" x 19⁵/₈"
Minimum Cabinet Size: 30"
Weight: 30 lbs.
Corner Radius: 25mm
Installation: Undermount

Accessories Optional
O3 O4 O5 O6 O7 O8 O9 O10

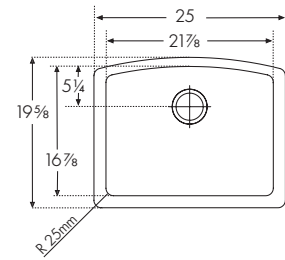

- Polar White
ELG11022PWT
125.0637.083
\$675
- Stone Grey
ELG11022SHG
125.0491.518
\$675
- NEW** Slate Grey
ELG11022SLG
125.0713.004
\$675
- Onyx
ELG11022ONY
125.0384.303
\$675
- Matte Black
ELG11022MBK
125.0699.538
\$675
- Champagne
ELG11022CHA
125.0384.307
\$675
- Oyster
ELG11022OYS
125.0384.306
\$675
- Mocha
ELG11022MOC
125.0384.304
\$675

Ellipse



ELG160
\$790

Interior Dimensions: 29³/₄" x 18⁷/₈" x 9" & 8"
Exterior Dimensions: 33" x 21³/₄"
Minimum Cabinet Size: 36"
Weight: 42 lbs.
Corner Radius: 25mm
Installation: Undermount

Accessories Optional
O2 O4 O5 O6 O7 O8 O9 O10

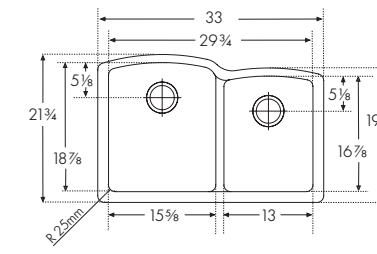

- Polar White
ELG160PWT
125.0637.085
\$790
- Stone Grey
ELG160SHG
125.0491.520
\$790
- NEW** Slate Grey
ELG160SLG
125.0713.008
\$790
- Onyx
ELG160ONY
125.0384.315
\$790
- Matte Black
ELG160MBK
125.0699.540
\$790
- Champagne
ELG160CHA
125.0384.319
\$790
- Oyster
ELG160OYS
125.0384.318
\$790
- Mocha
ELG160MOC
125.0384.316
\$790



ELG120
\$790

Interior Dimensions: 29⁷/₈" x 17" x 9"
Exterior Dimensions: 33" x 19³/₄"
Minimum Cabinet Size: 36"
Weight: 37 lbs.
Corner Radius: 25mm
Installation: Undermount

Accessories Optional
O1 O4 O5 O6 O7 O8 O9 O10

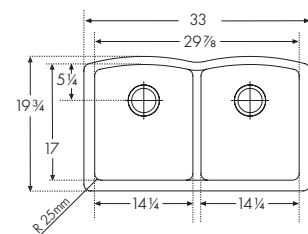

- Polar White
ELG120PWT
125.0637.084
\$790
- Stone Grey
ELG120SHG
125.0491.519
\$790
- NEW** Slate Grey
ELG120SLG
125.0713.006
\$790
- Onyx
ELG120ONY
125.0384.309
\$790
- Matte Black
ELG120MBK
125.0699.539
\$790
- Champagne
ELG120CHA
125.0384.313
\$790
- Oyster
ELG120OYS
125.0384.312
\$790
- Mocha
ELG120MOC
125.0384.310
\$790

ACCESSORIES OPTIONAL

- | | | | | | |
|--|--|---|--|--|--|
| <p>O1 Bottom Grid
11¹/₄" x 14¹/₄"
Stainless
ELG14-36S
112.0390.415
\$190</p> | <p>O2 Bottom Grid
13¹/₈" x 16¹/₈"
Stainless
ELG16-36S
112.0390.416
\$200</p> | <p>O3 Bottom Grid
19¹/₄" x 14¹/₄"
Stainless
ELG22-36S
112.0390.412
\$210</p> | <p>O4 Universal Roller Mat
18⁷/₁₆" x 20"
Stainless
UV-36RM
112.0391.220
\$225</p> | <p>O5 All-In Accessory System 1
AIUS100
112.0655.481
\$280</p> | <p>O6 All-In Accessory System 2
AIUS200
112.0655.488
\$350</p> |
| <p>O7 All-In Accessory System 3
AIUS300
112.0655.489
\$420</p> | <p>O8 Colorline Strainer Basket
900-PWT
900-SHG
900-SLG
900-MBK
900-CHA
900-OYS
900-MOC
\$100
Color shown is Champagne</p> | <p>O9 Colorline Disposer Flange Kit
WD-900-PWT
WD-900-SHG
WD-900-SLG
WD-900-MBK
WD-900-CHA
WD-900-OYS
WD-900-MOC
\$115
Color shown is Matte Black</p> | <p>O10 Strainer Basket
Chrome
1145
112.0055.508
\$80
Satin Nickel
1145SN
112.0185.195
\$115</p> | | |

Ellipse



ESCH25229-1
\$600

Interior Dimensions: 21⁷/₈" x 16⁷/₈" x 9"
Exterior Dimensions: 25" x 22"
Minimum Cabinet Size: 27"
Weight: 30 lbs.
Corner Radius: 25mm
Installation: Dual Mount
Pre-scored Faucet Hole: 1 to 4

Accessories Optional
O4 O5 O6 O7 O8 O9 O10

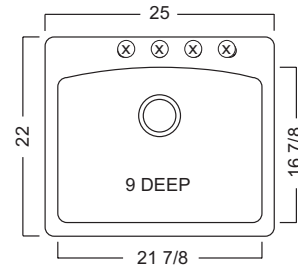

- Polar White
ESPW25229-1
114.0643.364
\$600
- Stone Grey
ESSG25229-1
114.0637.903
\$600
- NEW Slate Grey
ESSL25229-1
114.0713.010
\$600
- Onyx
ESOX25229-1
114.0087.736
\$600
- Matte Black
ESMB25229-1
114.0699.562
\$600
- Champagne
ESCH25229-1
114.0087.735
\$600
- Oyster
ESOY25229-1
114.0637.902
\$600
- Mocha
ESDB25229-1
114.0155.300
\$600

Ellipse



EOOX33229-1
\$675

Interior Dimensions: 29³/₄" x 18⁷/₈" x 16⁷/₈" x 9" & 8"
Exterior Dimensions: 33" x 22"
Minimum Cabinet Size: 36"
Weight: 42 lbs.
Corner Radius: 25mm
Installation: Dual Mount
Pre-scored Faucet Hole: 1 to 4

Accessories Optional
O2 O3 O5 O6 O7 O8 O9 O10

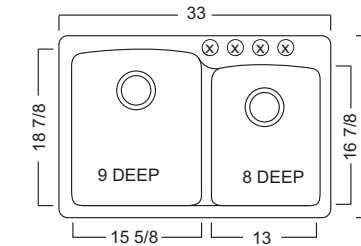

- Polar White
EOPW33229-1
114.0643.363
\$675
- Stone Grey
EOSG33229-1
114.0637.901
\$675
- NEW Slate Grey
EOSL33229-1
114.0713.074
\$675
- Onyx
EOOX33229-1
114.0087.734
\$675
- Matte Black
EOMB33229-1
114.0699.561
\$675
- Champagne
Eoch33229-1
114.0167.355
\$675
- Oyster
EOOY33229-1
114.0637.900
\$675
- Mocha
EODB33229-1
114.0155.299
\$675



EDDB33229-1
\$665

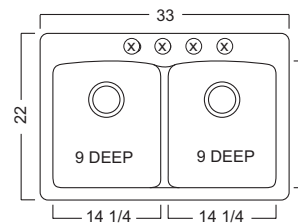

Interior Dimensions: 29⁷/₈" x 17" x 9"
Exterior Dimensions: 33" x 22"
Minimum Cabinet Size: 36"
Weight: 42 lbs.
Corner Radius: 25mm
Installation: Dual Mount
Pre-scored Faucet Hole: 1 to 4

Accessories Optional
O1 O5 O6 O7 O8 O9 O10



- Polar White
EDPW33229-1
114.0643.362
\$665
- Stone Grey
EDSG33229-1
114.0637.896
\$665
- NEW Slate Grey
EDSL33229-1
114.0713.072
\$665
- Onyx
EDOX33229-1
114.0087.733
\$665
- Matte Black
EDMB33229-1
114.0699.537
\$665
- Champagne
EDCH33229-1
114.0155.297
\$665
- Oyster
EDOY33229-1
114.0637.895
\$665
- Mocha
EDDB33229-1
114.0155.298
\$665

ACCESSORIES OPTIONAL

- | | | | | | |
|--|---|---|---|--|--|
| 
O1 Bottom Grid
11 ¹ / ₂ " x 14"
Stainless
FBGG1114
112.0185.330
\$140 | 
O2 Bottom Grid
10" x 14"
Stainless
FBGG1014
112.0185.332
\$135 | 
O3 Bottom Grid
12 ³ / ₄ " x 16"
Stainless
FBGG1316
112.0185.333
\$150 | 
O4 Bottom Grid
18 ³ / ₄ " x 13 ³ / ₄ "
Stainless
FBGG1914
112.0185.331
\$160 | 
O5 All-In Accessory System 1
AIUS100
112.0655.481
\$280 | 
O6 All-In Accessory System 2
AIUS200
112.0655.488
\$350 |
| 
O7 All-In Accessory System 3
AIUS300
112.0655.489
\$420 | 
O8 Colorline Strainer Basket
900-PWT
900-SHG
900-SLG
900-MBK
900-CHA
900-OYS
900-MOC
\$100
Color shown is Champagne | 
O9 Colorline Disposer Flange Kit
900-PWT
900-SHG
900-SLG
900-MBK
900-CHA
900-OYS
900-MOC
\$115
Color shown is Matte Black | 
O10 Strainer Basket
Chrome
1145
112.0055.508
\$80
Satin Nickel
1145SN
112.0185.195
\$115 | | |



- Farm House 156
- Manor House 160
- Cisterna 164

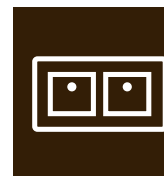

Fireclay

Sinks

A lifetime of service

Fireclay is entirely natural, very stylish and amazingly practical. We apply a dirt-repellent finishing polish, which means that any mess, tea or red wine can simply be wiped away with a little soapy water.

Silky smooth good looks

Fireclay sinks combine beautifully with a variety of work surfaces, such as wood, glass and granite. It's a durable choice that easily stands up to heat, staining and impact with ease.

How your fireclay is made

Liquid ceramic consisting of quartz, china clay and kaolin is injected into a mold under high pressure. Prior to drying, surface imperfections are smoothed with soft sponges and a level surface is created with water. The final drying process involves 20 hours in a tunnel kiln at 2,200°F. At every stage, each sink is subjected to stringent quality checks performed by experts to make it Franke approved.



Farm House

Classic elegance.



Farm House sinks portray sophisticated elegance from every angle, featuring a sleek flat front panel for added style. Franke's apron front Farm House sinks are made of durable fireclay for a smooth, polished finish that's both durable and easy to clean.



Easy to clean

A dirt-repellent finishing polish keeps stains like tea and red wine at bay, allowing them to be wiped away with only soap and water.



Spacious deep bowl

Maximizing sink capacity, Farm House offers deep bowls to give you the space you need to complete tasks with ease.

Designed for comfort

The apron front design enables the user to stand directly in front of the basin, with no cabinets or countertop in between, making it comfortable for prepping food and cleaning up.



MYTHOS

Farm House



FHK710-30WH
130.0079.634
\$1,455

Interior Dimensions: 28¹/₈" x 18¹/₄" x 9³/₁₆"
Exterior Dimensions: 30¹/₈" x 20" x 10¹/₈"
Minimum Cabinet Size: 30"
Weight: 103 lbs.
Corner Radius: 19mm
Installation: Undermount
Apron Front

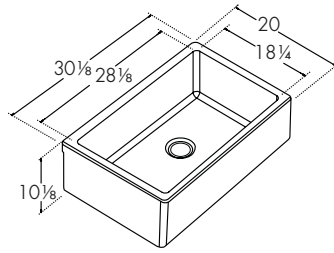

Accessories Optional

O1 **O4** **O5**

Note: Dimensions may vary by 2% (plus or minus) due to material attributes and firing process.
Special installation required; see website. Finished on front and back only.

ACCESSORIES OPTIONAL

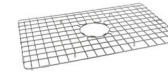

O1 Bottom Grid
27¹/₈" x 16¹/₂"
Stainless
FK30-36S
112.0191.591
\$340

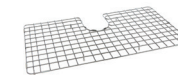

O2 Bottom Grid
29¹/₈" x 16¹/₂"
Stainless
FK33-36S
112.0191.592
\$375



O3 Bottom Grid
32¹/₈" x 16¹/₂"
Stainless
FK36-36S
112.0191.593
\$395



O4 Cutting Board
14¹/₂" x 21¹/₈"
Solid Wood
OA-40S
112.0046.923
\$480



O5 Strainer Basket
Chrome
1145
112.0055.508
\$80
Satin Nickel
1145SN
112.0185.195
\$115

MYTHOS



FHK710-33WH
130.0079.638
\$1,865

Interior Dimensions: 31⁷/₁₆" x 18¹/₄" x 9³/₁₆"
Exterior Dimensions: 33" x 20" x 10¹/₈"
Minimum Cabinet Size: 33"
Weight: 110 lbs.
Corner Radius: 19mm
Installation: Undermount
Apron Front

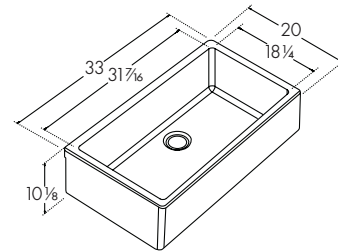

Accessories Optional

O2 **O4** **O5**

Note: Dimensions may vary by 2% (plus or minus) due to material attributes and firing process.
Special installation required; see website. Finished on front and back only.

MYTHOS



FHK710-36WH
130.0079.641
\$2,025

Interior Dimensions: 34⁷/₁₆" x 18¹/₄" x 9³/₁₆"
Exterior Dimensions: 36" x 20" x 10¹/₈"
Minimum Cabinet Size: 36"
Weight: 117 lbs.
Corner Radius: 19mm
Installation: Undermount
Apron Front

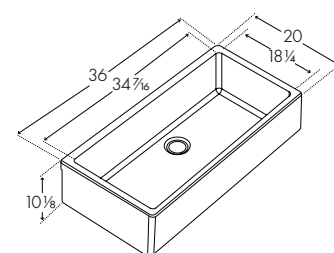

Accessories Optional

O3 **O4** **O5**

Note: Dimensions may vary by 2% (plus or minus) due to material attributes and firing process.
Special installation required; see website. Finished on front and back only.

Sink color may vary between each model.

Note: All accessories sold separately unless otherwise indicated. Design of custom accessories subject to change without notice. It is absolutely critical that you have the sink and any custom sink accessories on-site prior to any cut or modification to the countertop. Franke will not be responsible for any errors in countertop preparation and sink installation.

Manor House

Designed for endurance.



Villeroy & Boch brings centuries of excellence to the handcrafted beauty of Manor House apron front sinks. Scratch resistant and hygienic fireclay offers the most desired qualities in today's kitchens.



Apron front design

The apron front design enables the user to stand directly in front of the basin, with no cabinets or countertop in between, making it comfortable for prepping food.

A natural beauty

The CeramicPlus coating causes liquids to bead upon making contact with the sink's surface, repelling dirt, limescale and other residues, which are easily wiped off.



Highly durable

Fireclay is an extremely tough, scratch-resistant surface that is impervious to acids and bleaches.

Stain resistant

We apply a dirt-repellent finishing polish, which means that any mess, tea or red wine stains can simply be wiped away with a little soapy water.

MARIS

Manor House



MHK110-20WH
130.0066.192
\$735

Interior Dimensions: 18¹/₈" x 13¹/₄" x 5⁷/₈"
Exterior Dimensions: 19¹/₂" x 16" x 6³/₄"
Minimum Cabinet Size: 21"
Weight: 40 lbs.
Corner Radius: 12mm
Installation: Undermount
Apron Front

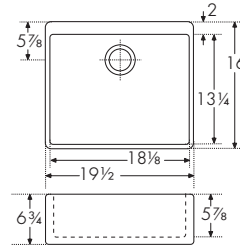

Accessories Optional



Note: Dimensions may vary by 2% (plus or minus) due to material attributes and firing process.
Pop-up strainer not compatible. Special installation required; see website. Finished on front and back only. Sink color may vary between each model.

MARIS



MHK110-24WH
130.0066.196
\$975

Interior Dimensions: 22" x 16⁷/₈" x 7¹/₈"
Exterior Dimensions: 23⁵/₈" x 19⁷/₈" x 8¹/₈"
Minimum Cabinet Size: 24"
Weight: 58 lbs.
Corner Radius: 12mm
Installation: Undermount
Apron Front

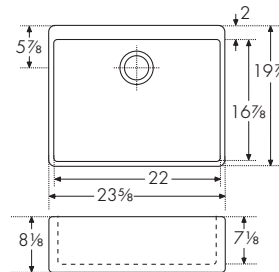

Accessories Optional



Note: Dimensions may vary by 2% (plus or minus) due to material attributes and firing process.
Pop-up strainer not compatible. Special installation required; see website. Finished on front and back only. Sink color may vary between each model.

MARIS



MHK110-28WH
130.0066.200
\$1,090

Interior Dimensions: 26" x 17³/₈" x 7¹/₈"
Exterior Dimensions: 27¹/₈" x 19⁷/₈" x 7⁷/₈"
Minimum Cabinet Size: 30"
Weight: 64 lbs.
Corner Radius: 12mm
Installation: Undermount
Apron Front

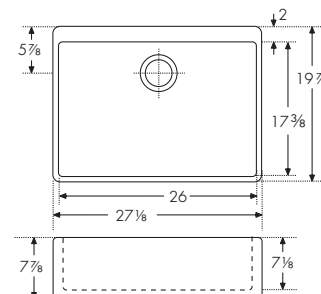

Accessories Optional



Note: Dimensions may vary by 2% (plus or minus) due to material attributes and firing process.
Pop-up strainer not compatible. Special installation required; see website. Finished on front and back only. Sink color may vary between each model.

MARIS

Manor House



MHK720-31WH
130.0066.206
\$1,205

Interior Dimensions: 29³/₄" x 17¹/₂" x 7⁵/₈"
Exterior Dimensions: 31¹/₄" x 19³/₄" x 8⁵/₈"
Minimum Cabinet Size: 33"
Weight: 82 lbs.
Corner Radius: 12mm
Installation: Undermount
Apron Front

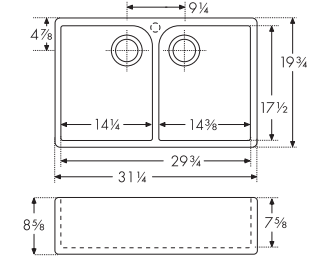

Accessories Optional



Note: Dimensions may vary by 2% (plus or minus), due to material attributes and firing process.
Pop-up strainer not compatible. Special installation required; see website. Finished on front and back only. Sink color may vary between each model.

MARIS



MHK720-35WH
130.0066.213
\$1,675

Interior Dimensions: 33⁵/₈" x 19³/₄" x 7⁷/₈"
Exterior Dimensions: 35¹/₂" x 21⁵/₈" x 8⁵/₈"
Minimum Cabinet Size: 36"
Weight: 96 lbs.
Corner Radius: 12mm
Installation: Undermount
Apron Front

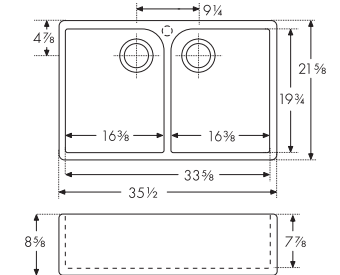

Accessories Optional



Note: Dimensions may vary by 2% (plus or minus), due to material attributes and firing process.
Pop-up strainer not compatible. Special installation required; see website. Finished on front and back only. Sink color may vary between each model.

ACCESSORIES OPTIONAL



O1 Bottom Grid
21" x 15"
Coated Stainless
MK24-36C
112.0066.244
\$290



O2 Bottom Grid
25³/₁₆" x 15"
Coated Stainless
MK28-36C
112.0066.246
\$325



O3 Cutting Board
14¹/₂" x 21¹/₈"
Solid Wood
OA-40S
112.0046.923
\$480



O4 Strainer Basket
Chrome
1145
112.0055.508
\$80
Satin Nickel
1145SN
112.0185.195
\$115

Cisterna

As beautiful as they are functional.



Created by Villeroy & Boch with a classic design offered in three sizes, the Cisterna fireclay sink is a perfect fit for the kitchen and beyond. Use the smallest size as a bar or prep sink — or pair it with a larger size to create a unique two-bowl design.



Exceptionally durable

Liquid ceramic undergoes a thorough refinement and firing process resulting in a beautifully smooth, hard-wearing, highly durable sink.



Sound absorbing

Fireclay is a naturally sound-absorbing material that reduces the noise caused by a garbage disposal or running water.

Simply stain resistant

Don't worry about red wine, coffee and other food stains. The CeramicPlus finish makes our fireclay sinks simple to clean. Soap and water are all it takes.



Cisterna



CCK110-13WH
126.0066.136
\$895

Interior Dimensions: 12⁵/₈" x 15³/₈" x 6⁷/₈"
Exterior Dimensions: 14³/₈" x 17¹/₈" x 7⁵/₈"
Minimum Cabinet Size: 18"
Weight: 29 lbs.
Corner Radius: 68mm
Installation: Undermount

Accessories Optional

O1 O3 O4 O5

Note: Dimensions may vary by 2% (plus or minus) due to material attributes and firing process. Pop-up strainer not compatible. Special installation required; see website. Sink color may vary between each model. Finished on front and back only.

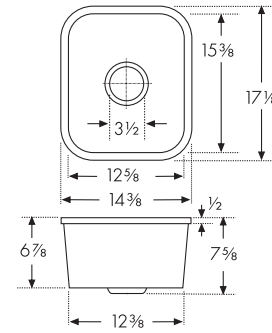

ACCESSORIES OPTIONAL



O1 Bottom Grid
13³/₄" x 10³/₁₆"
Coated Stainless
CK13-36C
112.0066.221
\$280
Limited Quantities

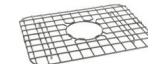

O2 Bottom Grid
18" x 13¹/₁₆"
Coated Stainless
CK19-36C
112.0066.223
\$310
Limited Quantities



O3 Cutting Board
14¹/₂" x 21¹/₂"
Solid Wood
OA-40S
112.0046.923
\$480

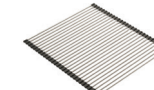

O4 Universal Roller Mat
18³/₁₆" x 20"
Stainless
UV-36RM
112.0391.220
\$225



O5 Strainer Basket
Chrome
1145
112.0055.508
\$80
Satin Nickel
1145SN
112.0185.195
\$115



CCK110-15WH
126.0066.141
\$930

Interior Dimensions: 15³/₈" x 15³/₈" x 6⁷/₈"
Exterior Dimensions: 17¹/₂" x 17¹/₂" x 7⁵/₈"
Minimum Cabinet Size: 21"
Weight: 33 lbs.
Corner Radius: 68mm
Installation: Undermount

Accessories Optional

O3 O4 O5

Note: Dimensions may vary by 2% (plus or minus) due to material attributes and firing process. Pop-up strainer not compatible. Special installation required; see website. Sink color may vary between each model. Finished on front and back only.

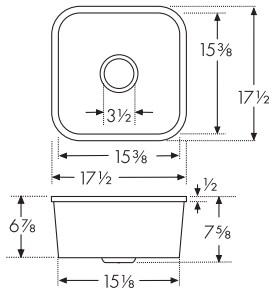

CCK110-19WH
126.0066.147
\$1,030

Interior Dimensions: 19⁵/₈" x 15³/₈" x 6⁷/₈"
Exterior Dimensions: 21⁵/₈" x 17³/₈" x 7⁵/₈"
Minimum Cabinet Size: 27"
Weight: 39 lbs.
Corner Radius: 68mm
Installation: Undermount

Accessories Optional

O2 O3 O4 O5

Note: Dimensions may vary by 2% (plus or minus) due to material attributes and firing process. Pop-up strainer not compatible. Special installation required; see website. Sink color may vary between each model. Finished on front and back only.

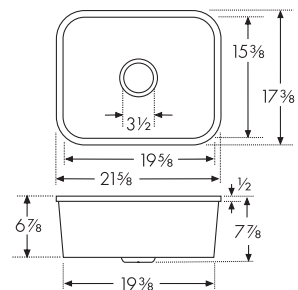

Note: All accessories sold separately unless otherwise indicated. Design of custom accessories subject to change without notice. It is absolutely critical that you have the sink and any custom sink accessories on-site prior to any cut or modification to the countertop. Franke will not be responsible for any errors in countertop preparation and sink installation.

Faucets



- 174 Icon
- 178 Centinox
- 180 Pescara
- 184 Atlas Neo
- 188 Steel
- 192 Active
- 196 Eos Neo
- 201 Smart



Faucets to the highest standards

From extravagant to the purist. From Industrial Black to Polished Chrome. Whether you prefer a semi-pro, pull-out or filtration, the Franke faucet range meets every kitchen's needs. Your favorite Franke faucet will perfectly match your ideal Franke sink.

Stainless steel

Outstanding quality comes together during the Franke manufacturing process. Stainless steel material is used throughout the faucet, both inside and out. The interior stainless steel component's durability exhibits longevity that other materials cannot. Franke uses lead-free stainless, so you can be assured it will not release into the water when it comes out of the faucet. The aesthetically pleasing look is corrosion and tarnish resistant and has a naturally hygienic surface.

Water-saving feature

Conserve natural resources and trim your water bill with Franke's water-saving feature. Move the handle to the first position for a water-saving 50% flow. Moving the handle to the second position allows for 100% flow. Look for faucets with the water-saving feature icon, as not all faucets have this feature



Quality assurance and certifications

Franke faucets are manufactured under the supervision and testing of local and international certifying bodies, including CSA, IAPMO, ICC, and NSF. All Franke faucets meet the requirements of the Federal Safe Drinking Water Act, NSF372, NSF61, and ASME A112.18.1\CSA B125.1.





Make your statement

Franke offers a large selection of premium faucet materials and finishes to complete the design statement in your well-appointed kitchen. Complement or contrast your sink or appliances with one of 12 available finishes, from Matte Black for a sophisticated, modern appeal, to earthy Stone Grey or our NEW Anthracite finish to accent cabinetry and countertops.

Franke stainless steel faucets do not have a coating or finish. They are manufactured with durable 304 and 316 stainless steel resulting in a surface resistant to wear and abrasion and ensuring a lifetime of function and satisfaction.



Icon

A legend in the making.



reddot winner 2023



Combining contemporary design inspired by nature plus a host of wonderful features, Icon is the perfect balance of aesthetics and functionality. The Icon pull-out and semi-pro faucets feature a Laminar aerator to reduce splashing.

Effortless control

The single handle lever controls the water flow as needed with a simple movement.



Slim body and high spout

The high spout and sleek design with a 360° swivel spout offers plenty of space when working with large cookware. The pivoting spray head offers both stream and spray water flows.



MYTHOS



ICN-SP-MBK
115.0690.402
\$1,575

1-Hole Semi-Pro
Finish: Matte Black
Flow Rate: 1.75 gpm
Spray Function: Toggle
Spray Type: Spray & Stream
Spout Swivel Range: 360°
Cartridge: 25mm Ceramic
Countertop Hole Diameter: 1 3/8"
Weight: 7 lbs.

Matte Black

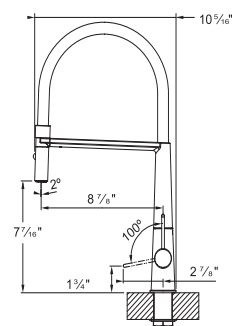

MYTHOS



ICN-PO-MBK
115.0690.401
\$1,260

1-Hole Pull-Out
Finish: Matte Black
Flow Rate: 1.75 gpm
Spray Function: Toggle
Spray Type: Spray & Stream
Spout Swivel Range: 360°
Cartridge: 25mm Ceramic
Countertop Hole Diameter: 1 3/8"
Weight: 6 lbs.

Matte Black

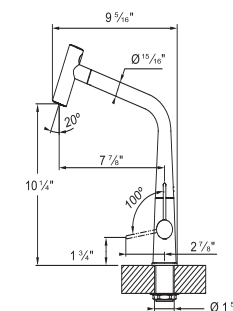

MYTHOS



ICN-PO-CHR
115.0690.303
\$1,050

1-Hole Pull-Out
Finish: Chrome
Flow Rate: 1.75 gpm
Spray Function: Toggle
Spray Type: Spray & Stream
Spout Swivel Range: 360°
Cartridge: 25mm Ceramic
Countertop Hole Diameter: 1 3/8"
Weight: 6 lbs.

Polished Chrome

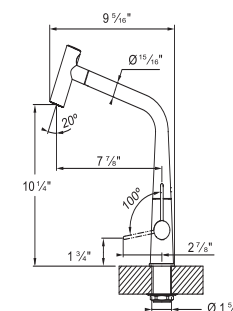

ADA Compliant: Product is compliant with the American Disabilities Act when properly installed. All faucets can accommodate at least 1-3/4" countertop thickness. Several can accommodate up to 3". Call for additional thicknesses. Recommended Pressure Range: 15-75 PSI. All Franke filtration faucets have been certified to comply with NSF 61/ANSI/CAN, Q ≤ 1; ASME A112.18.1/CSA B125.1; and NSF 372 drinking water system component requirements. These requirements meet California Health and Safety Code requirements for low lead as well as the low lead requirements of the US Safe Drinking Water Act. Franke faucets also meet the water efficiency requirements of the California Energy Commission and the US Department of Energy.

Centinox

Passion and precision.



MYTHOS



1-Hole Semi-Pro
 Flow Rate: 1.75 gpm
 Spray Function: Toggle
 Spray Type: Spray & Stream
 Spout Swivel Range: 360°
 Cartridge: 35mm Ceramic
 Countertop Hole Diameter: 1 3/8"
 Weight: 8 lbs.
 ADA Compliant



CEN-SP-304
 115.0547.857
\$955

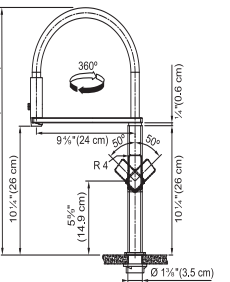

ADA Compliant: Product is compliant with the American Disabilities Act when properly installed. All faucets can accommodate at least 1-3/4" countertop thickness. Several can accommodate up to 3". Call for additional thicknesses. Recommended Pressure Range: 15-75 PSI. All Franke filtration faucets have been certified to comply with NSF 61/ANSI/CAN, Q ≤ 1; ASME A112.18.1/CSA B125.1; and NSF 372 drinking water system component requirements. These requirements meet California Health and Safety Code requirements for low lead as well as the low lead requirements of the US Safe Drinking Water Act. Franke faucets also meet the water efficiency requirements of the California Energy Commission and the US Department of Energy.

Pescara

Clean design and detailed craftsmanship.



The clean design and detailed craftsmanship make Franke's Pescara faucet line ideal for those who savor simplicity. Pescara faucets feature a level of functionality and performance that maximizes usability for the home chef or kitchen connoisseur.

Flexible coil spring hose

Flexible metal spring hose allows maximum reach of the entire sink.



Magnetic docking

An intuitive, quick-release, magnetic dock holds the spray head securely in place when not in use.

High-performance spray

Move smoothly from spray to stream without the need to reduce water pressure between modes.

Pescara

MYTHOS



PES-SPX-304
115.0435.802
\$1,175

1-Hole Semi-Pro
Flow Rate: 1.75 gpm
Spray Function: Toggle
Spray Type: Spray & Stream
Spout Swivel Range: 360°
Cartridge: 35mm Ceramic
Countertop Hole Diameter: 1 3/8"
Weight: 10 lbs.
Magnetic Spray Dock
ADA Compliant

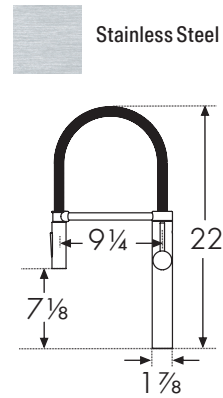

Stainless Steel

Pescara

MYTHOS



PES-PDX-SNI
115.0539.025
\$975

1-Hole Pull-Down
Flow Rate: 1.75 gpm
Spray Function: Toggle
Spray Type: Spray & Stream
Spout Swivel Range: 180°
Cartridge: 35mm Ceramic
Countertop Hole Diameter: 1 3/8"
Weight: 6 lbs.
ADA Compliant



Polished Chrome
PES-PDX-CHR
115.0539.024
\$805

Satin Nickel
PES-PDX-SNI
115.0539.025
\$975

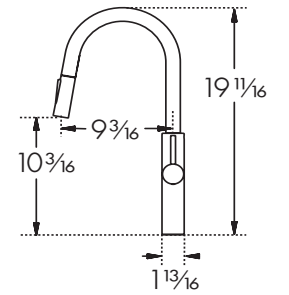

MYTHOS



PES-SP-304
115.0442.968
\$1,010

1-Hole Semi-Pro
Flow Rate: 1.75 gpm
Spray Function: Toggle
Spray Type: Spray & Stream
Spout Swivel Range: 360°
Cartridge: 25mm Ceramic
Countertop Hole Diameter: 1 3/8"
Weight: 8 lbs.
Magnetic Spray Dock
ADA Compliant

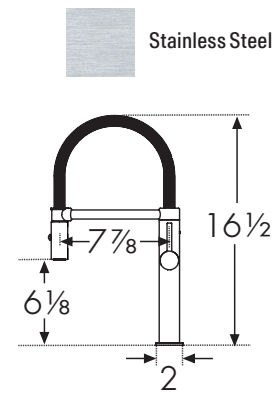

Stainless Steel

MYTHOS



PES-PD-MBK
115.0559.274
\$910

1-Hole Pull-Down
Flow Rate: 1.75 gpm
Spray Function: Toggle
Spray Type: Spray & Stream
Spout Swivel Range: 180°
Cartridge: 35mm Ceramic
Countertop Hole Diameter: 1 3/8"
Weight: 6 lbs.
ADA Compliant



Polished Chrome
PES-PD-CHR
115.0539.022
\$775

Satin Nickel
PES-PD-SNI
115.0539.023
\$910

Matte Black
PES-PD-MBK
115.0559.274
\$910

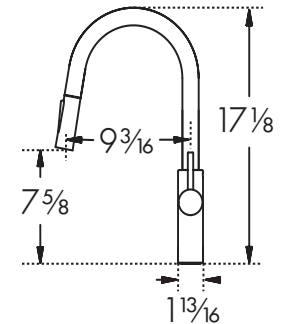

MYTHOS



PES-360-CHR
115.0395.996
\$805

1-Hole Semi-Pro
Flow Rate: 1.75 gpm
Spray Function: Toggle
Spray Type: Spray & Stream
Spout Swivel Range: 360°
Cartridge: 25mm Ceramic
Countertop Hole Diameter: 1 3/8"
Weight: 10 lbs.
Magnetic Spray Dock
ADA Compliant



Polished Chrome
PES-360-CHR
115.0395.996
\$805

Matte Black
PES-360-MBK
115.0558.369
\$975

Satin Nickel
PES-360-SNI
115.0395.997
\$975

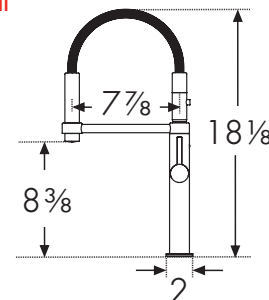

ADA Compliant: Product is compliant with the American Disabilities Act when properly installed. All faucets can accommodate at least 1-3/4" countertop thickness. Several can accommodate up to 3". Call for additional thicknesses. Recommended Pressure Range: 15-75 PSI. All Franke filtration faucets have been certified to comply with NSF 61/ANSI/CAN, Q ≤ 1; ASME A112.18.1/CSA B125.1; and NSF 372 drinking water system component requirements. These requirements meet California Health and Safety Code requirements for low lead as well as the low lead requirements of the US Safe Drinking Water Act. Franke faucets also meet the water efficiency requirements of the California Energy Commission and the US Department of Energy.

Atlas

Neo

Modern design, built to last.



The Atlas Neo stainless steel material gives you the benefits of high performance and low maintenance. The material is corrosion-resistant, scratch-proof, and stain-resistant. Stainless steel has a hygienic, non-porous surface that is resistant to bacteria and germs. This faucet will give years of performance and service, making it a perfect solution for everyday sustainability.

Features and benefits

Single side lever

The linear side lever functions well in a variety of installation configurations. It can be rotated through 0 to 180° for easy and precise adjustment of water flow.

Pull-out spray

The pull-out head offers easy maneuverability for any cooking or cleaning task.

Laminar aerator

High quality laminar aerators help to reduce the air in the water stream producing a consistent water flow that is non-splashing.



Atlas Neo

MARIS



1-Hole Pull-Out
 Flow Rate: 1.75 gpm
 Spray Function: Toggle
 Spray Type: Spray & Stream
 Spout Swivel Range: 180°
 Cartridge: 35mm Ceramic
 Countertop Hole Diameter: 1 3/8"
 Weight: 7 lbs.



Stainless Steel

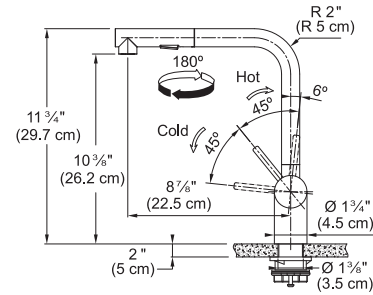

ATL-PO-304
 115.0685.311
\$810

MARIS



Hole Size: 1 1/8"
 Weight: 1 lb.
 Capacity: 11.5 oz.

NEW ATL-SD-ANT
 112.0625.485
\$315

- | | |
|--|--|
|  Stainless Steel
ATL-SD-316
112.0625.483
\$315 |  Gold
ATL-SD-GLD
112.0681.200
\$315 |
|  Industrial Black
ATL-SD-IBK
112.0625.484
\$315 |  Anthracite
ATL-SD-ANT
112.0625.485
\$315 |

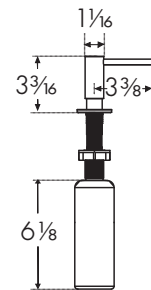

ADA Compliant: Product is compliant with the American Disabilities Act when properly installed. All faucets can accommodate at least 1-3/4" countertop thickness. Several can accommodate up to 3". Call for additional thicknesses. Recommended Pressure Range: 15-75 PSI. All Franke filtration faucets have been certified to comply with NSF 61/ANSI/CAN, Q ≤ 1; ASME A112.18.1/CSA B125.1; and NSF 372 drinking water system component requirements. These requirements meet California Health and Safety Code requirements for low lead as well as the low lead requirements of the US Safe Drinking Water Act. Franke faucets also meet the water efficiency requirements of the California Energy Commission and the US Department of Energy.

Steel

The perfect stainless steel faucet.



The Steel faucets are built in solid, corrosion-resistant stainless steel and equipped with a 35mm cartridge for a highly functional, long-lasting experience. The single-lever handle offers you the exact amount and temperature of water in one twist.

Features and benefits

Full coverage swivel

The 360-degree swivel spout generates a full range of motion, allowing you the flexibility to reach almost any area of your sink. The tall arch design offers exceptional space for cleaning or filling large pots and pans.

Dual-function spray head

Delivering a more powerful stream thanks to the needle spray used, it is easier to rinse fruits and vegetables, as well as remove stubborn food from dishes. The stream can also reach every part of the sink, making it easier to clean.

Complete collection

Complete the look with a Universal filtration faucet.



MYTHOS



STL-PD-316
115.0619.312
\$1,070

1-Hole Pull-Down
Flow Rate: 1.75 gpm
Spray Function: Toggle
Spray Type: Spray & Stream
Spout Swivel Range: 360°
Cartridge: 35mm Ceramic
Countertop Hole Diameter: 1 3/8"
Weight: 8 lbs.
316 Stainless Steel
ADA Compliant



Steel

316 Stainless Steel

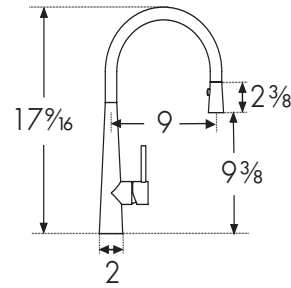

MYTHOS



STL-BR-304
115.0355.505
\$620

1-Hole Bar
Flow Rate: 1.75 gpm
Spray Type: Stream
Spout Swivel Range: 360°
Cartridge: 35mm Ceramic
Countertop Hole Diameter: 1 3/8"
Weight: 5 lbs.
ADA Compliant



Steel

Stainless Steel
STL-BR-304
115.0355.505
\$620

Gold
STL-BR-GLD
115.0689.828
\$760

Industrial Black
STL-BR-IBK
115.0619.308
\$760

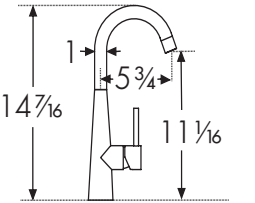

MYTHOS



STL-PD-GLD
115.0689.823
\$1,070

1-Hole Pull-Down
Flow Rate: 1.75 gpm
Spray Function: Toggle
Spray Type: Spray & Stream
Spout Swivel Range: 360°
Cartridge: 35mm Ceramic
Countertop Hole Diameter: 1 3/8"
Weight: 8 lbs.
ADA Compliant



Stainless Steel
STL-PD-304
115.0355.504
\$875

Gold
STL-PD-GLD
115.0689.823
\$1,070

Industrial Black
STL-PD-IBK
115.0619.306
\$1,070

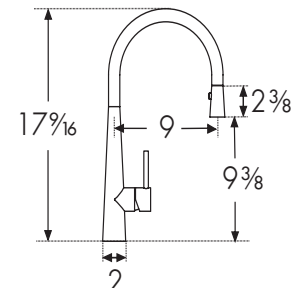

MYTHOS



STL-PO-304
115.0361.293
\$795

1-Hole Pull-Out
Flow Rate: 1.75 gpm
Spray Function: Toggle
Spray Type: Spray & Stream
Spout Swivel Range: 150°
Cartridge: 35mm Ceramic
Countertop Hole Diameter: 1 3/8"
Weight: 8 lbs.
ADA Compliant



Stainless Steel
STL-PO-304
115.0361.293
\$795

Gold
STL-PO-GLD
115.0689.827
\$975

Industrial Black
STL-PO-IBK
115.0619.309
\$975

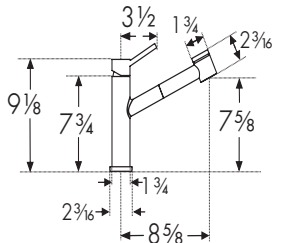

MYTHOS



STL-PR-IBK
115.0619.307
\$975

1-Hole Pull-Down Prep
Flow Rate: 1.75 gpm
Spray Function: Toggle
Spray Type: Spray & Stream
Spout Swivel Range: 360°
Cartridge: 35mm Ceramic
Countertop Hole Diameter: 1 3/8"
Weight: 8 lbs.
ADA Compliant



Stainless Steel
STL-PR-304
115.0355.506
\$795

Gold
STL-PR-GLD
115.0689.826
\$975

Industrial Black
STL-PR-IBK
115.0619.307
\$975

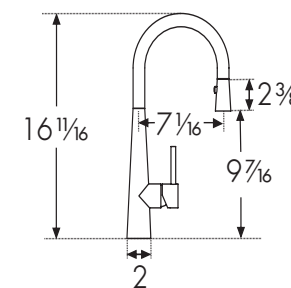

MYTHOS



STL-PF-304
115.0355.507
\$875

Wall Mount Pot Filler
Flow Rate: 2.2 gpm
Spout Swivel Range: 180°
Cartridge: 1/2" Ceramic
Weight: 6 lbs.
ADA Compliant



Stainless Steel

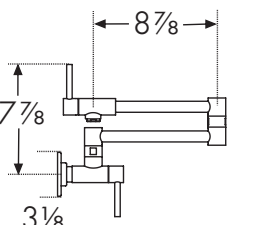

ADA Compliant: Product is compliant with the American Disabilities Act when properly installed. All faucets can accommodate at least 1-3/4" countertop thickness. Several can accommodate up to 3". Call for additional thicknesses. Recommended Pressure Range: 15-75 PSI. All Franke filtration faucets have been certified to comply with NSF 61/ANSI/CAN, Q ≤ 1; ASME A112.18.1/CSA B125.1; and NSF 372 drinking water system component requirements. These requirements meet California Health and Safety Code requirements for low lead as well as the low lead requirements of the US Safe Drinking Water Act. Franke faucets also meet the water efficiency requirements of the California Energy Commission and the US Department of Energy.

Active

Exceptional design, inside and out.



Stylishly sustainable

ECO Cartridge uses up to 50% less water

Our Active faucets offer the best of both worlds — design and sustainability. With three design options, available in a range of stunning contemporary finishes, the appeal is obvious.

The secret to this performance is the environmentally beneficial ECO cartridge, which is designed to limit both the flow and temperature of the water.

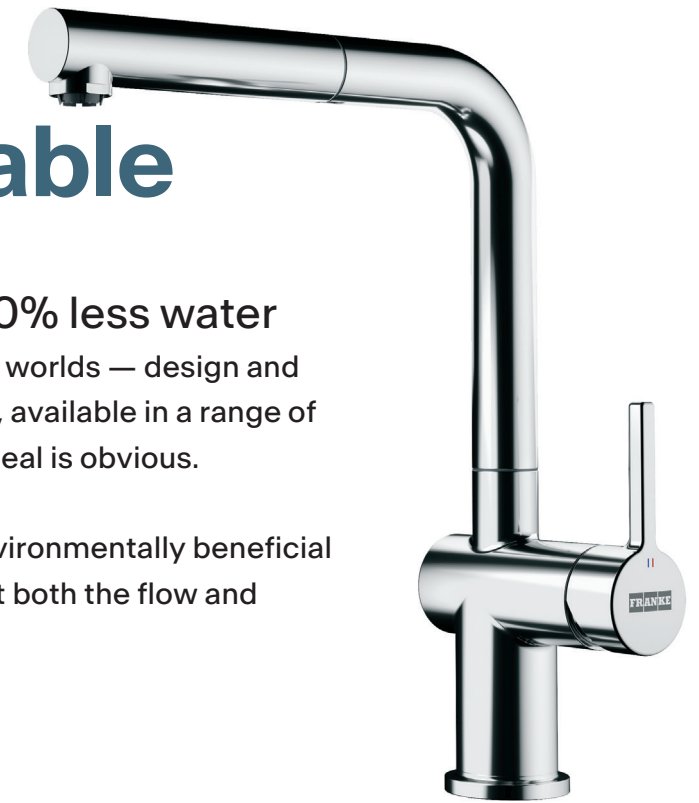

The efficiency of sustainability, made beautiful.

Active Faucet Semi-pro

Inimitable style and exceptional function.



- Polished Chrome
- Matte Black

Active Faucet Harmonic J-Spout

In a choice of contemporary colors.



- Polished Chrome
- Matte Black

Active Faucet Pure L-Spout

Available in a number of soft, sophisticated hues.



- Polished Chrome
- Matte Black
- Oyster
- Stone Grey
- Champagne
- Onyx
- Polar White



Sufficient water pressure at just 50% open

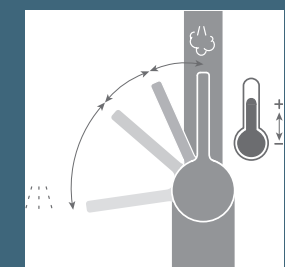

Remove the lever and turn the ring nut inside to limit the flow temperature*

*Always refer to the installation manual

MYTHOS



ACT-SP-CHR
115.0688.968
\$895

1-Hole Semi-Pro
Flow Rate: 1.75 gpm
Spray Function: Toggle
Spray Type: Spray & Stream
Spout Swivel Range: 180°
Cartridge: 35mm Ceramic
Countertop Hole Diameter: 1 3/8"
Weight: 7 lbs.
ADA Compliant



Polished Chrome
ACT-SP-CHR
115.0688.968
\$895

Matte Black
ACT-SP-MBK
115.0688.970
\$1,050

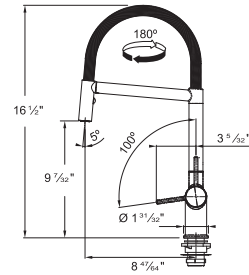

16 1/2"
9 7/16"
3 9/16"
8 1/16"
1 3/16"

MARIS



ACT-SD-STG
119.0565.123
\$200

Countertop Hole Diameter: 1 3/8"
Weight: 1 lbs.
Capacity: 10 oz.

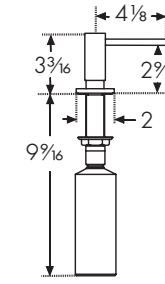

4 1/8"
3 3/16"
2 9/16"
2"
9 9/16"

Active

Polished Chrome
ACT-SD-CHR
119.0547.902
\$160

Stone Grey
ACT-SD-STG
119.0565.123
\$200

Sain Nickel
ACT-SD-SNI
119.0547.904
\$200

Polar White
ACT-SD-PWT
112.0633.079
\$200

Onyx
ACT-SD-ONY
119.0565.112
\$200

Oyster
ACT-SD-OYS
119.0565.119
\$200

Matte Black
ACT-SD-MBK
119.0547.906
\$200

Champagne
ACT-SD-CHA
119.0565.120
\$200

MARIS



ACT-PO-CHR
115.0656.842
\$705

1-Hole Pull-Out
Flow Rate: 1.75 gpm
Spray Function: Toggle
Spray Type: Spray & Stream
Spout Swivel Range: 360°
Cartridge: 35mm Ceramic
Countertop Hole Diameter: 1 3/8"
Weight: 7 lbs.
ADA Compliant



Polished Chrome
ACT-PO-CHR
115.0656.842
\$705

Polar White
ACT-PO-PWT
115.0656.851
\$855

Onyx
ACT-PO-ONY
115.0656.849
\$855

Oyster
ACT-PO-OYS
115.0656.853
\$855

Matte Black
ACT-PO-MBK
115.0656.848
\$855

Champagne
ACT-PO-CHA
115.0656.852
\$855

Stone Grey
ACT-PO-STG
115.0656.850
\$855

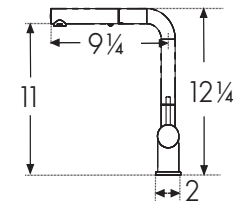

11
9 1/4"
12 1/4"
2"

MARIS



ACT-PD-MBK
115.0656.858
\$855

1-Hole Pull-Down
Flow Rate: 1.75 gpm
Spray Function: Toggle
Spray Type: Spray & Stream
Spout Swivel Range: 360°
Cartridge: 35mm Ceramic
Countertop Hole Diameter: 1 3/8"
Weight: 8 lbs.
ADA Compliant



Polished Chrome
ACT-PD-CHR
115.0656.854
\$705

Matte Black
ACT-PD-MBK
115.0656.858
\$855

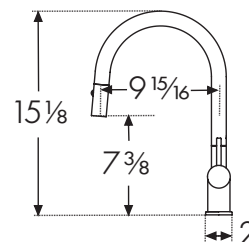

15 1/8"
9 15/16"
7 3/8"
2"

ADA Compliant: Product is compliant with the American Disabilities Act when properly installed. All faucets can accommodate at least 1-3/4" countertop thickness. Several can accommodate up to 3". Call for additional thicknesses. Recommended Pressure Range: 15-75 PSI. All Franke filtration faucets have been certified to comply with NSF 61/ANSI/CAN, Q ≤ 1; ASME A112.18.1/CSA B125.1; and NSF 372 drinking water system component requirements. These requirements meet California Health and Safety Code requirements for low lead as well as the low lead requirements of the US Safe Drinking Water Act. Franke faucets also meet the water efficiency requirements of the California Energy Commission and the US Department of Energy.

Eos Neo

Modern clean lines.



The Eos Neo combines all the advantages of a modern faucet in a straightforward design: A high arc spout makes it even easier to rinse out the sink or quickly fill a large pot. The single-lever mixer offers you the exact amount and temperature of water in one twist.

Perfect water flow

The handle has a 0 - 90 degree movement for a perfect temperature and water flow control.



Solid 304 and 316 stainless

The Eos Neo faucets are constructed with 304 and 316 stainless steel that is corrosion resistant inside and out.

Pull-down spray head

The pull-down spray head can be used with stream or a powerful spray for more efficient cleaning.

MARIS



EOS-PD-316
115.0685.297
\$1,005

1-Hole Pull-Down
Flow Rate: 1.75 gpm
Spray Function: Toggle
Spray Type: Spray & Stream
Spout Swivel Range: 180°
Cartridge: 35mm Ceramic
Countertop Hole Diameter: 1 3/8"
Weight: 10 lbs.
316 Stainless Steel
ADA Compliant



Eos Neo

316 Stainless Steel

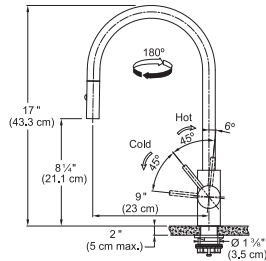

MYTHOS



EOS-PR-IBK
115.0685.303
\$960

1-Hole Pull-Down Prep
Flow Rate: 1.75 gpm
Spray Function: Toggle
Spray Type: Spray & Stream
Spout Swivel Range: 180°
Cartridge: 35mm Ceramic
Countertop Hole Diameter: 1 3/8"
Weight: 10 lbs.
ADA Compliant



Eos Neo

Industrial Black
EOS-PR-IBK
115.0685.303
\$960
Gold
EOS-PR-GLD
115.0685.309
\$960

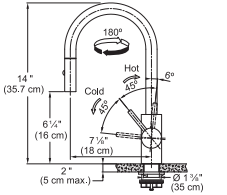

MYTHOS



EOS-PD-ANT
115.0700.765
\$1,005

1-Hole Pull-Down
Flow Rate: 1.75 gpm
Spray Function: Toggle
Spray Type: Spray & Stream
Spout Swivel Range: 180°
Cartridge: 35mm Ceramic
Countertop Hole Diameter: 1 3/8"
Weight: 10 lbs.
ADA Compliant



NEW Anthracite
EOS-PD-ANT
115.0700.765
\$1,005
Gold
EOS-PD-GLD
115.0685.308
\$1,005
Industrial Black
EOS-PD-IBK
115.0685.302
\$1,005

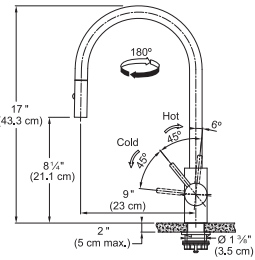

MARIS



EOS-PR-304
115.0685.299
\$785

1-Hole Pull-Down Prep
Flow Rate: 1.75 gpm
Spray Function: Toggle
Spray Type: Spray & Stream
Spout Swivel Range: 180°
Cartridge: 35mm Ceramic
Countertop Hole Diameter: 1 3/8"
Weight: 10 lbs.
ADA Compliant



Stainless Steel

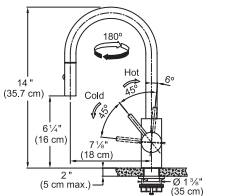

MARIS



EOS-PD-304
115.0685.298
\$870

1-Hole Pull-Down
Flow Rate: 1.75 gpm
Spray Function: Toggle
Spray Type: Spray & Stream
Spout Swivel Range: 180°
Cartridge: 35mm Ceramic
Countertop Hole Diameter: 1 3/8"
Weight: 10 lbs.
ADA Compliant



Stainless Steel

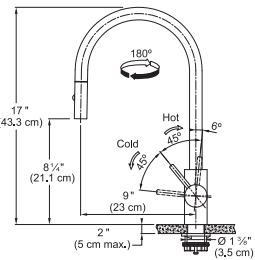

MYTHOS



EOS-BR-GLD
115.0685.310
\$780

1-Hole Bar
Flow Rate: 1.75 gpm
Spray Type: Stream
Spout Swivel Range: 180°
Cartridge: 35mm Ceramic
Countertop Hole Diameter: 1 3/8"
Weight: 5 lbs.
ADA Compliant



Industrial Black
EOS-BR-IBK
115.0685.307
\$780
Gold
EOS-BR-GLD
115.0685.310
\$780

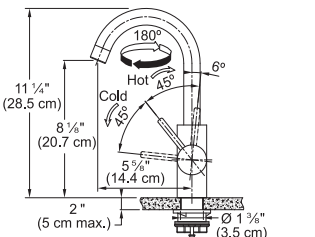

ADA Compliant: Product is compliant with the American Disabilities Act when properly installed. All faucets can accommodate at least 1-3/4" countertop thickness. Several can accommodate up to 3". Call for additional thicknesses. Recommended Pressure Range: 15-75 PSI. All Franke filtration faucets have been certified to comply with NSF 61/ANSI/CAN, Q ≤ 1; ASME A112.18.1/CSA B125.1; and NSF 372 drinking water system component requirements. These requirements meet California Health and Safety Code requirements for low lead as well as the low lead requirements of the US Safe Drinking Water Act. Franke faucets also meet the water efficiency requirements of the California Energy Commission and the US Department of Energy.

MARIS



Eos Neo



Stainless Steel

1-Hole Bar
Flow Rate: 1.75 gpm
Spray Type: Stream
Spout Swivel Range: 180°
Cartridge: 35mm Ceramic
Countertop Hole Diameter: 1 3/8"
Weight: 5 lbs.
ADA Compliant

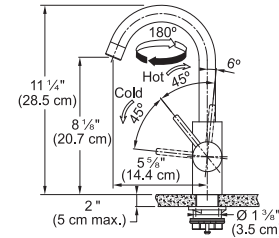

EOS-BR-304
115.0685.300
\$675

Smart



SMA-PO-CHR
115.0391.483
\$585

1-Hole Pull-Out
Flow Rate: 1.75 gpm
Spray Function: Toggle
Spray Type: Spray & Stream
Spout Swivel Range: 110°
Cartridge: 35mm Ceramic
Countertop Hole Diameter: 1 3/8"
Weight: 6 lbs.
ADA Compliant



Polished Chrome
SMA-PO-CHR
115.0391.483
\$585

Satin Nickel
SMA-PO-SNI
115.0391.485
\$730

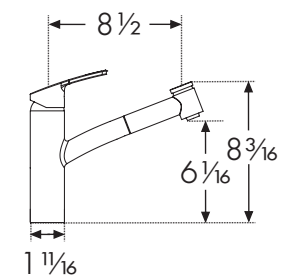



Filtration Systems 204
Accessories and Filters 210



Water

Filtering

Filtration

Refresh what's possible.

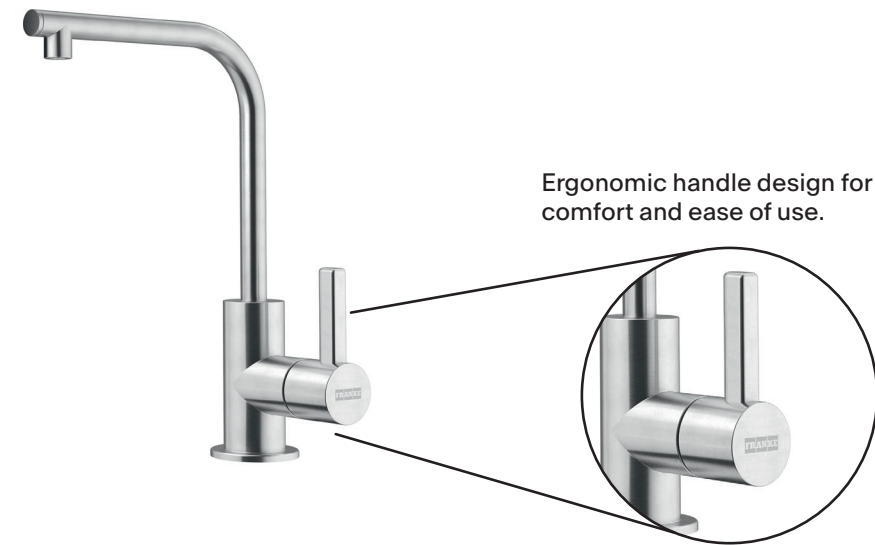

In-home water treatment provides the final barrier of protection to prevent contaminants being ingested by you or a family member. Franke Universal filtration systems supply filtered water directly from the faucet, ensuring that the quality of water you drink and prepare your food with is safe.

Features and benefits

Full-service suite

Today's kitchens are the hub of the home, and many homeowners are seeking unique, complete design choices in every area. Franke filtration faucets offer a fully integrated design and wellness solution.

Stainless steel construction

Made from stainless steel inside and out, Franke filtration faucets are durable, lead-free, and easy to maintain. The non-porous material is resistant to bacteria and germs, making it a more hygienic choice for the kitchen.

Cohesive design solutions

With the flexibility to work within any style, our filtration faucets perfectly complement our wide range of Franke faucets to bring a balanced look to your kitchen. Available in four finishes: Stainless Steel, Polished Chrome, Industrial Black and Gold.

Sustainable solutions

A Franke water filtration system reduces the need for plastic bottles, which is good for the environment.



Filtration System



High performance filtration systems designed to deliver pure, great-tasting water.

Carbon block made of coconut carbon

- Reduces chlorine, pesticides, herbicides and toxic chemicals, as well as improves taste and odor
- Coconut carbon is the most effective way to remove contaminants
- Retains high oxygen of spring water

Eco-friendly cartridges

- 100% natural and recyclable materials
- Longer life through higher capacity
- Franke filter lasts 600 gallons

Excellent filtration

- 0.5 Sub micron filtration
- Self-sterilizing ceramic imbedded with silver
- Removes pathogenic organisms (E Coli, Salmonella, Cholera, etc.)

Four Stage Filter

Franke four-stage filters combine multiple technologies to remove contaminants in the water, to deliver up to 600 gallons of fresh drinking water straight from the filtration faucet. NSF53 and NSF42 certified.

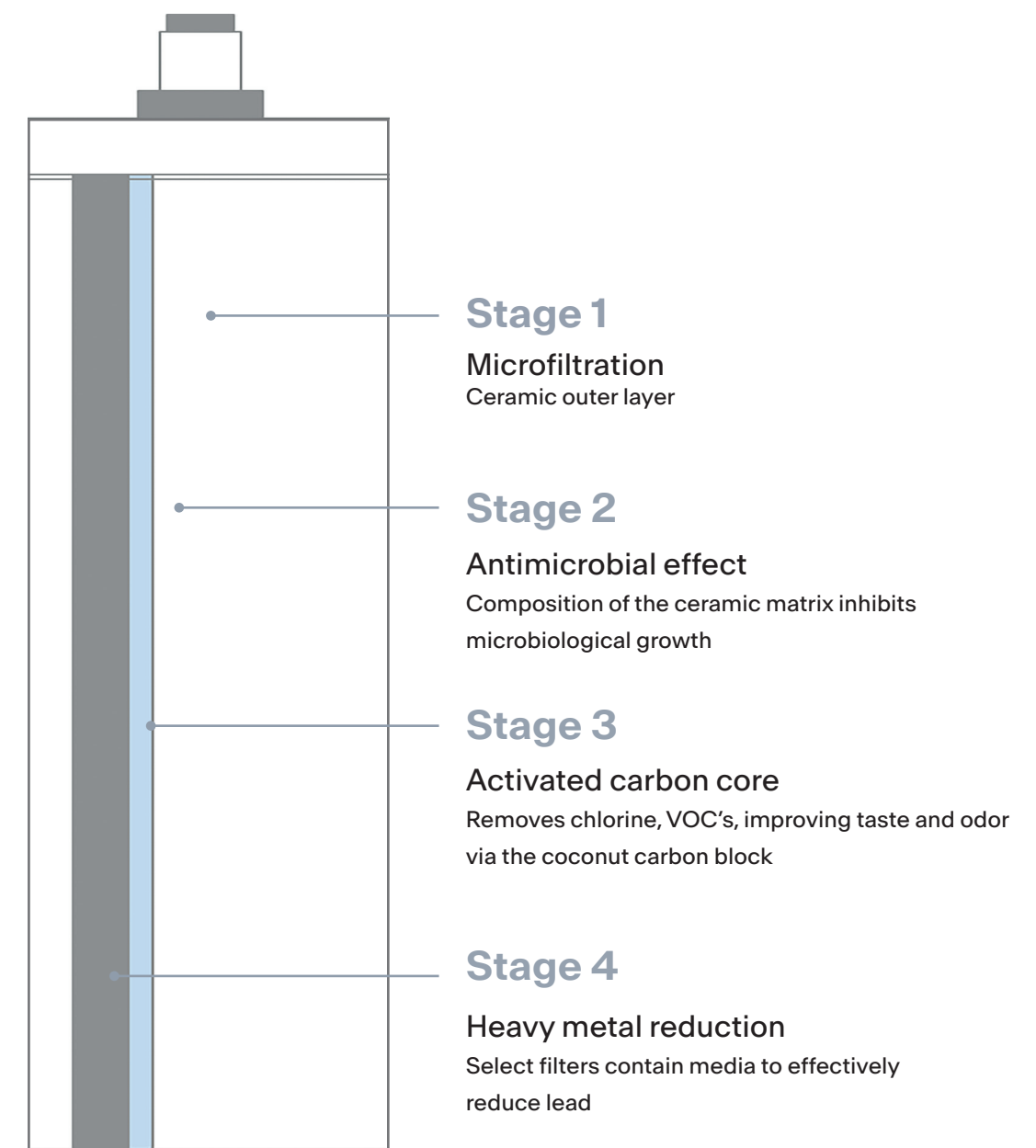

Filtration

MARIS



UNL-FW-304
Universal Filtration
120.0704.773
\$625

Universal Cold Filtered
Flow Rate: 1.75 gpm
Spray Function: Stream
Spout Swivel Range: 360°
Cartridge: 3/8" Ceramic
Countertop Hole Diameter: 1 1/4"
Weight: 3.75 lbs.
ADA Compliant

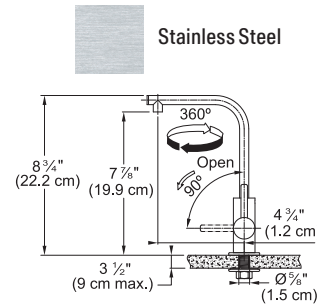

MARIS







UNJ-FW-GLD
Universal Filtration
120.0704.770
\$745

Universal Cold Filtered
Flow Rate: 1.75 gpm
Spray Function: Stream
Spout Swivel Range: 360°
Cartridge: 3/8" Ceramic
Countertop Hole Diameter: 1 1/4"
Weight: 3.75 lbs.
ADA Compliant



Filtration

- | | |
|--|---|
|  Polished Chrome
UNJ-FW-CHR
120.0704.763
\$600 |  Industrial Black
UNJ-FW-IBK
120.0704.767
\$745 |
|  Stainless Steel
UNJ-FW-304
120.0704.764
\$625 |  Gold
UNJ-FW-GLD
120.0704.770
\$745 |

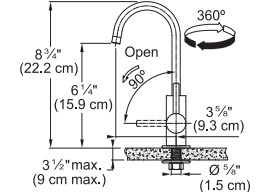

MARIS



UNL-HO-304
Universal Filtration
119.0704.774
\$655

Universal Hot Filtered
Flow Rate: 1.75 gpm
Spray Function: Stream
Spout Swivel Range: 360°
Cartridge: 3/8" Ceramic
Countertop Hole Diameter: 1 1/4"
Weight: 3.75 lbs.
ADA Compliant

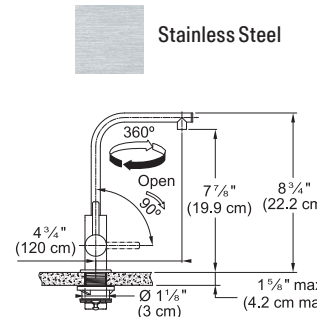





MARIS



UNJ-HO-304
Universal Filtration
119.0704.765
\$655

Universal Hot Filtered
Flow Rate: 1.75 gpm
Spray Function: Stream
Spout Swivel Range: 360°
Cartridge: 3/8" Ceramic
Countertop Hole Diameter: 1 1/4"
Weight: 3.75 lbs.
ADA Compliant



- | | |
|--|---|
|  Polished Chrome
UNJ-HO-CHR
119.0704.807
\$625 |  Industrial Black
UNJ-HO-IBK
119.0704.768
\$770 |
|  Stainless Steel
UNJ-HO-304
119.0704.765
\$655 |  Gold
UNJ-HO-GLD
119.0704.771
\$770 |

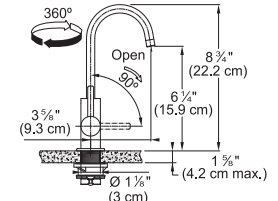

MARIS



UNL-HC-304
Universal Filtration
120.0704.806
\$735

Universal Hot/Cold Filtered
Flow Rate: 1.75 gpm
Spray Function: Stream
Spout Swivel Range: 360°
Cartridge: 3/8" Ceramic
Countertop Hole Diameter: 1 1/4"
Weight: 3.75 lbs.
ADA Compliant

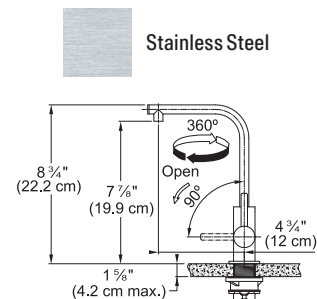





MARIS



UNJ-HC-IBK
Universal Filtration
120.0704.769
\$890

Universal Hot/Cold Filtered
Flow Rate: 1.75 gpm
Spray Function: Stream
Spout Swivel Range: 360°
Cartridge: 3/8" Ceramic
Countertop Hole Diameter: 1 1/4"
Weight: 3.75 lbs.
ADA Compliant



- | | |
|--|---|
|  Polished Chrome
UNJ-HC-CHR
120.0704.808
\$735 |  Industrial Black
UNJ-HC-IBK
120.0704.769
\$890 |
|  Stainless Steel
UNJ-HC-304
120.0704.766
\$755 |  Gold
UNJ-HC-GLD
120.0704.772
\$890 |

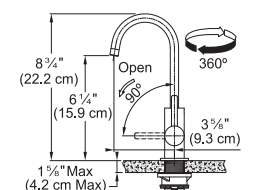

Indicates:  Cold  Hot  Hot/Cold

ADA Compliant: Product is compliant with the American Disabilities Act when properly installed. All faucets can accommodate at least 1-3/4" countertop thickness. Several can accommodate up to 3". Call for additional thicknesses. Recommended Pressure Range: 15-75 PSI. All Franke filtration faucets have been certified to comply with NSF 61/ANSI/CAN, Q ≤ 1; ASME A112.18.1/CSA B125.1; and NSF 372 drinking water system component requirements. These requirements meet California Health and Safety Code requirements for low lead as well as the low lead requirements of the US Safe Drinking Water Act. Franke faucets also meet the water efficiency requirements of the California Energy Commission and the US Department of Energy.

Filtration



HT-400
119.0596.202
\$600

Heats up to 60 cups per hour close to boiling temperature
8 pre-set temperature settings
Electronic temperature control, max 208 degrees
3/8 gallon stainless steel tank
1100 Watts
5 year warranty
8 lbs.
Compatible with RO water systems
For use with all Franke hot only and hot/cold filtration faucets.

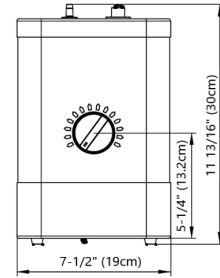

FRCNSTR
133.0171.120
\$445

FRC06 filter cartridge included
Fits FRC06, FRC07, FRC08, FRC09 and FRC10 filters
Solid stainless steel housing
Easy installation bracket included
Quick connect 3/8" push fitting
5 year warranty
4 lbs.

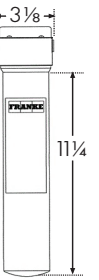

CT-200
119.0355.537
\$1,450

Chills 1 gallon per hour
Water temperature 40 degrees
Power: cord, 4 feet, 115 volts, 60 HZ
135 Watts
Stainless steel tank & tubing
1 year limited warranty
25 lbs.
Compatible with RO water systems
For use with all Franke cold only filtration faucets.

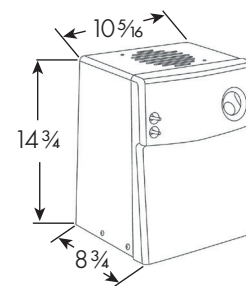

FRCNSTR-DUO-1
133.0361.290
\$500

FRC06 and FRC09 filters included
Fits FRC06, FRC07, FRC08, FRC09 and FRC10 filters
Thermoplastic housing
Built-in shutoff valve
Integrated installation bracket
Quick connect 3/8" push fitting
10 year warranty
BPA Free
6 lbs.

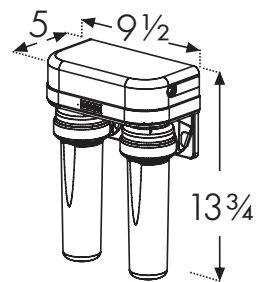

FRCNSTR100
133.0204.098
\$280

FRC06 filter cartridge included
Fits FRC06, FRC07, FRC08, FRC09 and FRC10 filters
Thermoplastic housing
Built-in shutoff valve
Integrated installation bracket
Quick connect 3/8" push fitting
10 year warranty
BPA Free
3 lbs.

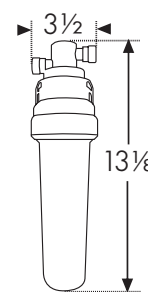

FRC06
133.0178.205
\$105

Reduces:

- Chlorine (taste and odor)
- Particulate and turbidity
- Cysts (Cryptosporidium)
- Lead

Note: See filter product data sheet on page 212 for details on specific contaminants filtered.

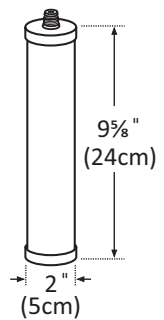

FRC06-2PK
133.0538.939
\$195

Filtration



Reduces:

- Chlorine (taste and odor)
- Particulate and turbidity
- Cysts (Cryptosporidium)
- Lead

Note: See filter product data sheet below for details on specific contaminants filtered.

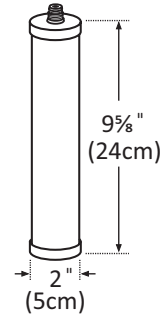

FRX02
133.0081.412
\$105

FRX02-2PK
133.0538.938
\$195



Reduces:

- Sediment

Note: See filter product data sheet below for details on specific contaminants filtered.

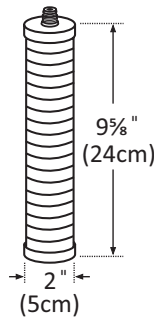

FRC09
133.0361.288
\$90

How to determine which filter to order if the replacement filter model number is not identified on the canister:

1. Locate the serial number on your canister
2. If the serial number begins with FR then order the FRX02 filter set
3. If the serial number begins with FRC then order the FRC06, and FRC09 filter set

FILTRATION CRITERIA	PRIMARY FILTERS		PRE-FILTERS
	FRX02	FRC06	FRC09
Reduces Chlorine	X	X	
Reduces Particulates and Turbidity	X	X	
Reduces Cysts (Cryptosporidium)	X	X	
Reduces Bacteria (E Coli)	X	X	
Reduces Insecticides and Herbicides	X	X	
Reduces Lead	X	X	
Reduces Sediment			X





- 216 All-In
- 220 Soap Dispensers
- 222 Waste Disposers
- 230 Colorline
- 232 Accessories



Kitchen

Solutions

It all comes together with **ALL IN**

The all-in solution for chopping, draining, washing and storing your preparations. Transforming any sink with a bowl dimension of up to 21 1/4" into a stylish and playful workstation, All-In is the flexible food preparation system designed to bring more flow to your kitchen and life.



Eight accessories, endless uses, fits any sink*



*Up to 21 1/4"

Prepare



Using the bamboo board, telescopic bridge, colander and collector bowls, All-In can help you:

- Chop vegetables and other ingredients
- Collect the cut food
- Collect peeling and handle waste
- Store prepped ingredients in the fridge

Cook



The bridge, colander and foldable mat are really useful at the cooking stage and you can:

- Rest pots and pans on the bridge while filling them from the faucet
- Use the colander to drain pasta or other ingredients
- Stand hot pans and dishes on the foldable mat to protect work surfaces

Clean



When it's time to wash up, the bridge, colanders and foldable mat can also help you to:

- Drain glasses and dishes
- Drain cutlery and cooking utensils

Tidy



Once the washing up is finished, All-In can still help you to tidy everything away, whether it's to:

- Store cleaning items in the sink
- Keep all accessories together in the storage container
- Put everything away neatly in your kitchen cabinets



EIGHT ACCESSORIES, ENDLESS USES



Featuring extendable stainless steel rails with durable handles that will adjust to fit bowls up to 21¼". Incorporates small feet that sit against the sink edge to ensure a stable fit.



The perfect size to accommodate slicing, dicing, chopping and more. The chopping board fits securely into the bridge or can be used on the countertop.



Made from Sanitized® Polypropylene, the large colander allows you to do all your rinsing fruits and vegetables and draining pasta over the sink.



Pair the small colander and prep bowl in the bridge for a multi-purpose prep station. The colander is perfect for rinsing, and the bowl is ideal for collecting stems or peels.



The small bowl can be used for collecting prepared ingredients and storing them in the fridge. Equally, it can be used for collecting peelings and dealing with waste during preparation.



Placed securely on top of the small bowl, the bamboo lid can help to keep food fresh.

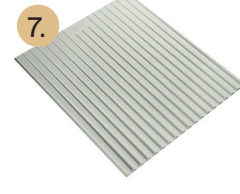

Foldable for easy storage and an inclined surface for use as a dish drying mat that channels water back into the sink.



Accommodates and stores the All-In accessories in one place so that everything is easily accessible for your meal prep.



Telescopic Bridge
7" x Extends to
24"



Bamboo
Chopping Board
8" x 13"



Large Colander
7" x 12"



Telescopic Bridge
7" x Extends to
24"



Bamboo
Chopping Board
8" x 13"



Small Colander
7" x 7"



Prep Bowl
7" x 7"



Bamboo Bowl Lid
7" x 7"

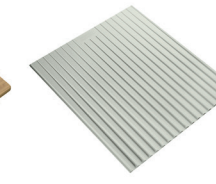

Foldable
Silicone Mat
14" x 16"



Telescopic Bridge
7" x Extends to
24"



Bamboo
Chopping Board
8" x 13"



Large Colander
7" x 12"



Small Colander
7" x 7"



Prep Bowl
7" x 7"



Bamboo Bowl Lid
7" x 7"

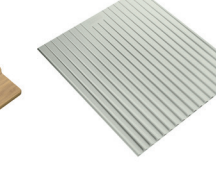

Foldable
Silicone Mat
14" x 16"



Storage
Container
11" x 21"

Kit 1

AIUS100

112.0655.481

\$280

- Stainless telescopic bridge
- Bamboo chopping board
- Large colander

Kit 2

AIUS200

112.0655.488

\$350

- Stainless telescopic bridge
- Bamboo chopping board
- Small colander
- Small prep bowl
- Bamboo bowl lid
- Foldable silicone mat

Kit 3

AIUS300

112.0655.489

\$420

- Stainless telescopic bridge
- Bamboo chopping board
- Large colander
- Small colander
- Small prep bowl
- Bamboo bowl lid
- Foldable silicone mat
- Storage container

Soap Dispensers



UNI-SD-CHR
119.0068.281
\$375

Hole Size: 1 1/8"
Weight: 2 lbs.
Capacity: 16 oz.

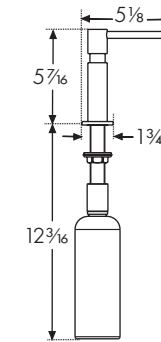

Polished Chrome
UNI-SD-CHR
119.0068.281
\$375

Satin Nickel
UNI-SD-SNI
119.0437.314
\$450



NEW ATL-SD-ANT
112.0625.485
\$315

Hole Size: 1 1/8"
Weight: 2 lbs.
Capacity: 11.5 oz.

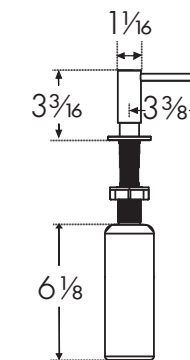

Stainless Steel
ATL-SD-316
112.0625.483
\$315

Gold
ATL-SD-GLD
112.0681.200
\$315

Industrial Black
ATL-SD-IBK
112.0625.484
\$315

Anthracite
ATL-SD-ANT
112.0625.485
\$315



ACT-SD-PWT
112.0633.079
\$200

Hole Size: 1 1/8"
Weight: 2 lbs.
Capacity: 10 oz.

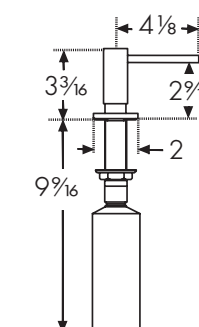

Polished Chrome
ACT-SD-CHR
119.0547.902
\$160

Stone Grey
ACT-SD-STG
119.0565.123
\$200

Satin Nickel
ACT-SD-SNI
119.0547.904
\$200

Polar White
ACT-SD-PWT
112.0633.079
\$200

Onyx
ACT-SD-ONY
119.0565.112
\$200

Oyster
ACT-SD-OYS
119.0565.119
\$200

Matte Black
ACT-SD-MBK
119.0547.906
\$200

Champagne
ACT-SD-CHA
119.0565.120
\$200

Waste Disposers

NEW



We have advanced our technology to deliver unmatched performance, effortlessly tackling even the toughest food waste. Even if your kitchen is spotless, throwing away food waste in the trash can lead to unpleasant smells and unwanted pests. The trash can become a breeding ground for harmful bacteria that thrive on discarded food. With a Franke waste disposer, you can minimize food waste, eliminate kitchen odors and reduce household bacteria.



Twist Force

The ultimate answer to effortlessly grind through food waste in no time. Powered by the remarkable Twist Force DC motor, it delivers instant full torque to conquer even the most stubborn food scraps, eliminating the risk of jams. With its exceptional power you will spend less time operating your disposer. Compatible with septic systems.



Sound Softening

Experience the ultimate noise reduction with our specially engineered molded insulated shell. It effectively traps and muffles noise from the sink opening, ensuring a peaceful kitchen environment. Additionally, our full-trim shell provides an extra layer of noise restriction, enhancing the overall noise reduction capabilities of our disposers.



Magnetic Rim

In an ideal scenario, only food waste would end up in the disposer. However, we understand that real life is not always perfect. Occasionally, unintended objects may accidentally fall into the disposer. That's why Franke disposers feature a Magnetic Rim designed to prevent most metal objects from entering the disposer. Featured on FWDS125 and FWDS100 models.



Waste Disposer



NEW **FWDS125**
1-1/4 HP Disposer
134.0713.686
\$670

Horsepower: 1 1/4
Feed: Continuous
RPM: 2800
Hygiene Safeguard
Sound Softening Insulated Shell
Stainless Steel Grinding Chamber
Twist Force Balanced Grinding System
Jam Resistant
Cast Impellers
Removable Splash Guard
Magnetic Rim Metal Guard
Three Bolt installation
Integrated Air Switch Connection
12 Year In-Home Warranty
Weight: 12 lbs.

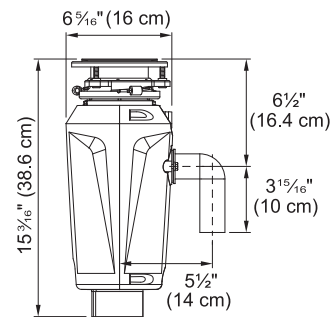

NEW **FWDS50**
1/2 HP Disposer
134.0713.702
\$210

Horsepower: 1/2
Feed: Continuous
RPM: 2600
Hygiene Safeguard
Stainless Steel Grinding Chamber
Twist Force Balanced Grinding System
Jam Resistant
Stamped Impellers
Removable Splash Guard
Three Bolt installation
6 Year In-Home Warranty
Weight: 11 lbs.

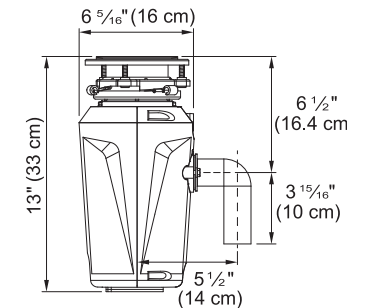

NEW **FWDS100**
1 HP Disposer
134.0713.689
\$550

Horsepower: 1
Feed: Continuous
RPM: 2750
Hygiene Safeguard
Sound Softening Insulated Shell
Stainless Steel Grinding Chamber
Twist Force Balanced Grinding System
Jam Resistant
Cast Impellers
Removable Splash Guard
Magnetic Rim Metal Guard
Three Bolt installation
Integrated Air Switch Connection
10 Year In-Home Warranty
Weight: 12 lbs.

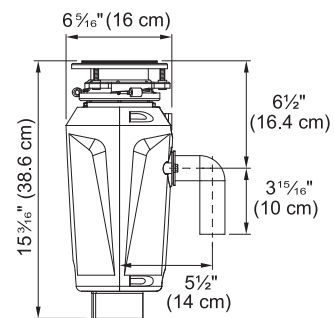

NEW **FWDS75BF**
3/4 HP Disposer
134.0713.701
\$500
Available Summer 2024

Horsepower: 3/4
Feed: Batch Feed
RPM: 2700
Hygiene Safeguard
Sound Softening Insulated Shell
Stainless Steel Grinding Chamber
Twist Force Balanced Grinding System
Jam Resistant
Cast Impellers
Removable Splash Guard
Three Bolt installation
8 Year In-Home Warranty
Weight: 13 lbs.

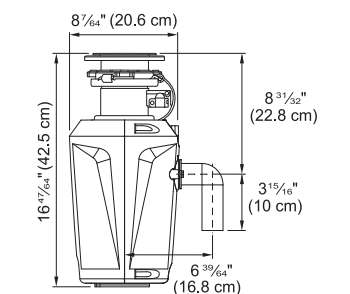

NEW **FWDS75**
3/4 HP Disposer
134.0713.690
\$400

Horsepower: 3/4
Feed: Continuous
RPM: 2700
Hygiene Safeguard
Sound Softening Insulated Shell
Stainless Steel Grinding Chamber
Twist Force Balanced Grinding System
Jam Resistant
Cast Impellers
Removable Splash Guard
Three Bolt installation
Integrated Air Switch Connection
8 Year In-Home Warranty
Weight: 12 lbs.

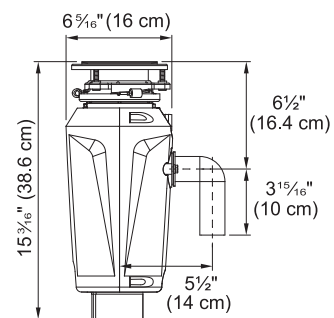

Waste Disposer

Specification Guide

DESCRIPTION	FWDS125	FWDS100	FWDS75	FWDS75BF	FWDS50
Motor	2800 rpm Jam-Resistant DC motor	2750 rpm Jam-Resistant DC motor	2700 rpm Jam-resistant DC motor	2700 rpm Jam-resistant DC motor	2600 rpm Jam-resistant DC motor
Feed Type	Continuous	Continuous	Continuous	Batch Feed	Continuous
Sound Feature	Sound Softening Technology	Sound Softening Technology	Sound Softening Technology	Sound Softening Technology	N/A
Grind Feature	TwistForce Grinding	TwistForce Grinding	TwistForce Grinding	TwistForce Grinding	TwistForce Grinding
Hygiene Feature	Hygiene Safeguard	Hygiene Safeguard	Hygiene Safeguard	Hygiene Safeguard	Hygiene Safeguard
Sink Baffle	Removable Splashguard	Removable Splashguard	Removable Splashguard	Removable Splashguard	Removable Splashguard
Integrated Air Switch Connection	Yes	Yes	Yes	No	No
Magnetic Rim Metal Guard	Yes	Yes	No	No	No
Septic Approved	Yes	Yes	Yes	Yes	Yes
Chamber Size	29 oz. 0.86 liters	29 oz. 0.86 liters	29 oz. 0.86 liters	29 oz. 0.86 liters	29 oz. 0.86 liters
Warranty	12 Year In-Home	10 Year In-Home	8 Year In-Home	8 Year In-Home	6 Year In-Home

Franke waste disposers are  certified Finer grinding for septic system compatibility in ALL models, with no additional chemicals needed.



Waste Disposer



WD9088
Controller
112.0073.934
\$170

Controller
Requires Disposer and Air Switch
For Continuous Feed Models
Weight: 1 lb.

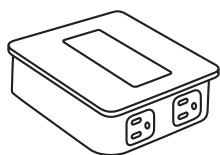

WD3428GLD
Disposer Air Switch
112.0664.347
\$55

Hole Size: 1 3/8"
Weight: 4 oz.

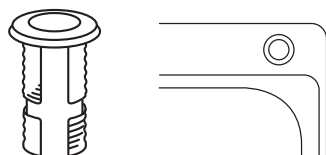

Chrome
WD3428C
112.0073.918
\$45

Black
WD3428BK
112.0073.916
\$45

NEW Anthracite
WD3428ANT
112.0664.346
\$55

Satin Nickel
WD3428SN
112.0073.921
\$45

NEW Gold
WD3428GLD
112.0664.347
\$55

Waste Disposer



WD-900-SHG
Colorline Disposer Flange Kit
112.0657.442
\$115

Hole Size: 3 1/2"
Strainer Basket Included
Weight: 3.5 oz

Polar White
WD-900-PWT
112.0657.433
\$115

Stone Grey
WD-900-SHG
112.0657.442
\$115

Oyster
WD-900-OYS
112.0657.436
\$115

Mocha
WD-900-MOC
112.0657.434
\$115

Champagne
WD-900-CHA
112.0657.422
\$115

Slate Grey
WD-900-SLG
112.0712.028
\$115

Onyx/Matte Black
WD-900-MBK
112.0657.421
\$115



WDFLANGE-EX-SN
Extended Disposer Flange
133.0661.444
\$95

Hole Size: 3 1/2"
Weight: 4 oz
Stopper not included.

Satin Nickel
WDFLANGE-EX-SN
133.0661.444
\$95

White
WDFLANGE-EX-WH
112.0653.058
\$95

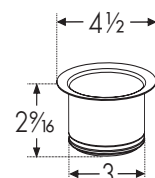

WDFLANGE-SS
Disposer Flange
112.0488.278
\$95

Hole Size: 3 1/2"
Weight: 4 oz
Stopper included.

Stainless Steel
WDFLANGE-SS
112.0488.278
\$95

Chrome
WDFLANGE-CH
112.0488.279
\$95

NEW Gold
WDFLANGE-GLD
112.0664.391
\$140

NEW Anthracite
WDFLANGE-ANT
112.0664.350
\$140

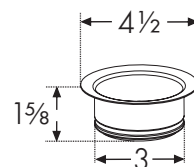

Colorline

Elegant, harmonious, made for each other.



With Franke's Colorline drain cover and waste kit collection, you can achieve a modern coordinated finish for your kitchen. These drain covers and waste kits are available in a variety of colors, allowing you to create a harmonious and integrated look between your sink and faucet.

In addition to their visual appeal and practicality, Franke's Colorline collection is made with high-quality materials, ensuring durability and longevity.

Colorline is ideal for seamless looking Granite sinks



Matte Black/Onyx



Stone Grey



Slate Grey



Polar White



Mocha



Oyster



Champagne



Matte Black/Onyx



Oyster



Polar White

Accessories



900-SHG
Colorline Strainer Basket
112.0657.093
\$100

Hole Size: 3 1/2"
Strainer Basket Included
Weight: 1 lb.

-  Polar White
900-PWT
112.0657.077
\$100
-  Stone Grey
900-SHG
112.0657.093
\$100
-  Oyster
900-OYS
112.0657.092
\$100
-  Mocha
900-MOC
112.0657.091
\$100

-  Champagne
900-CHA
112.0657.094
\$100
-  Slate Grey
900-SLG
112.0711.973
\$100
-  Onyx/Matte Black
900-MBK
112.0657.076
\$100



WD-900-PWT
Colorline Disposer Flange Kit
112.0657.433
\$115

Hole Size: 3 1/2"
Strainer Basket Included
Weight: 1 lb.



-  Polar White
WD-900-PWT
112.0657.433
\$115
-  Stone Grey
WD-900-SHG
112.0657.442
\$115
-  Oyster
WD-900-OYS
112.0657.436
\$115
-  Mocha
WD-900-MOC
112.0657.434
\$115

-  Champagne
WD-900-CHA
112.0657.422
\$115
-  Slate Grey
WD-900-SLG
112.0712.028
\$115
-  Onyx/Matte Black
WD-900-MBK
112.0657.421
\$115



906
Strainer Basket
112.0344.294
\$100

Hole Size: 3 1/2"
Strainer Basket Included
Weight: 1 lb.

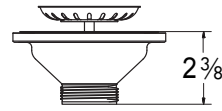

-  Chrome
906
112.0344.294
\$100
-  Satin Nickel
906SN
112.0344.505
\$125

-  Gold
906-GLD
112.0629.750
\$200
-  Anthracite
906-ANT
112.0630.003
\$200



1145
Strainer Basket
112.0055.508
\$80

Hole Size: 3 1/2"
Strainer Basket Included
Weight: 1 lb.

-  Chrome
1145
112.0055.508
\$80
-  Satin Nickel
1145SN
112.0185.195
\$115

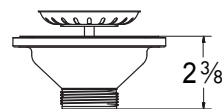

900W
Strainer Basket White
112.0048.590
\$80

Hole Size: 3 1/2"
Strainer Basket Included
Weight: 1 lb.

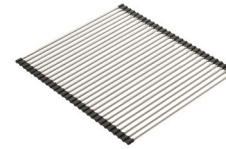
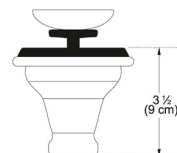

UV-36RM
Universal Roller Mat
112.0391.220
\$225

For Use Over Sink Or Counter
Compatible With Most Sinks
Holds Up To 40 lbs.
Use As A Trivet
Dishwasher Safe
Stainless Steel Rods
18 7/16" x 20"
Weight: 2 lbs.



PKXCVR
Square Drain Cover
112.0169.254
\$135

4 7/8" x 4 7/8"
Feet Are Coated
Weight: 1 lb.



PKGCVR
Square Drain Cover
112.0395.171
\$120

4 7/8" x 4 7/8"
Feet Are Coated
Weight: 1 lb.



RNDCVR-Stainless
Colorline Drain Cover
112.0532.169
\$120

4 1/2"
Feet Are Coated
Weight: 1 lb.



903
Inox Cream
112.0039.150
\$50

Stainless Steel Cleaner
Volume: 250 ml

Accessories

-  Polar White
RNDCVR-PWT
112.0657.184
\$65
-  Stone Grey
RNDCVR-SHG
112.0657.150
\$65
-  Oyster
RNDCVR-OYS
112.0657.119
\$65
-  Mocha
RNDCVR-MOC
112.0657.185
\$65

-  Champagne
RNDCVR-CHA
112.0657.211
\$65
-  Slate Grey
RNDCVR-SLG
112.0712.082
\$65
-  Onyx/Matte Black
RNDCVR-MBK
112.0657.146
\$65
-  Stainless Steel
RNDCVR-Stainless
112.0532.169
\$120

Sinks and Accessories

Sinks and Accessories

	MODEL NO.	BOTTOM GRID	CUTTING MAT	CUTTING BOARD	CUTTING BOARD	COLANDER	ROLLER MAT	ACCESS #1	ACCESS #2	ACCESS #3	ACCESS #4	STRAINER BASKET	PAGE NO.
MYTHOS MATERPIECE	MMX11015-ANT-WKC	MM15-36S-ANT		MM-40S		MM 70S-ANT	MM 31RM-ANT	FLANGE KIT WDFLANGE-ANT	AIR SWITCH WD3428ANT			906-ANT	38
		Included											
	MMX11015-GLD-WKC	MM15-36S-GLD		MM-40S		MM 70S-GLD	MM 31RM-GLD	FLANGE KIT WDFLANGE-GLD	AIR SWITCH WD3428GLD			906-GLD	38
		Included											
	MMX11027-ANT-WKC	MM27-36S-ANT		MM-40S		MM 70S-ANT	MM 31RM-ANT	FLANGE KIT WDFLANGE-ANT	AIR SWITCH WD3428ANT			906-ANT	38
	Included		Included		Included	Included							
	MMX11027-GLD-WKC	MM27-36S-GLD		MM-40S		MM 70S-GLD	MM 31RM-GLD	FLANGE KIT WDFLANGE-GLD	AIR SWITCH WD3428GLD			906-GLD	39
	Included		Included		Included	Included							
CULINARY CENTER	CUX11010-W		SP-40S	CU-40S	CU-40P	CUW-70S		CU-KS KNIFE SET	CU-WR WIRE RACK	CU-FC FRAME COVER		1145	43
			Included	Included	Included	Included		Included	Included	Included		Included	
	CUX16021-W	CU21-36S	SP-40S	CU-40S	CU-40P	CUW-70S		CU-KS KNIFE SET	CU-WR WIRE RACK	CU-FC FRAME COVER	RNDCVR DRAIN COVER	1145	43
		Included	Included	Included	Included	Included		Included	Included	Included	One Included	Included	
PEAK	PKX1108					PX-70S	UV-36RM	903 INOX CREAM	PKXCVR DRAIN COVER			1145 1145SN	54
									Included				
	PKX11013	PX-13S				PX-70S	UV-36RM	903 INOX CREAM	PKXCVR DRAIN COVER			1145 1145SN	54
									Included				
	PKX11016	PX-16S		PX-40S		PX-70S	UV-36RM	903 INOX CREAM	PKXCVR DRAIN COVER			1145 1145SN	54
									Included				

	MODEL NO.	BOTTOM GRID	CUTTING MAT	CUTTING BOARD	COLANDER	ROLLER MAT	ACCESS #1	ACCESS #2	ACCESS #3	STRAINER BASKET	PAGE NO.
PEAK	PKX11018	PX-18S		PX-40S	PX-70S	UV-36RM	903 INOX CREAM	PKXCVR DRAIN COVER		1145 1145SN	55
								Included			
	PKX11021	PX-21S		PX-40S	PX-70S	UV-36RM	903 INOX CREAM	PKXCVR DRAIN COVER		1145 1145SN	55
								Included			
	PKX11025	PX-25S		PX-40S	PX-70S	UV-36RM	903 INOX CREAM	PKXCVR DRAIN COVER		1145 1145SN	56
								Included			
	PKX11028	PX-28S		PX-40S	PX-70S	UV-36RM	903 INOX CREAM	PKXCVR DRAIN COVER		1145 1145SN	56
								Included			
	PKX160 PKX160LH	PX-21S		PX-40S	PX-70S	UV-36RM	903 INOX CREAM	PKXCVR DRAIN COVER		1145 1145SN	56
								Included			
	PKX11028-WKC	PX-28S		PX-40S	PX-70S	UV-36RM	903 INOX CREAM	PKXCVR DRAIN COVER		1145	46, 58
		Included		Included	Included			Included		Included	
PROFESSIONAL	PS2X110-15	PS2-15-36S		PS2-45S	PE-70S	RM18S	903 INOX CREAM	RNDCVR DRAIN COVER		1145 1145SN	62
								Included			
	PS2X110-18	PS2-18-36S		PS2-45S	PE-70S	RM18S	903 INOX CREAM	RNDCVR DRAIN COVER		1145 1145SN	62
								Included			
	PS2X110-21	PS2-21-36S		PS2-45S	PE-70S	RM18S	903 INOX CREAM	RNDCVR DRAIN COVER		1145 1145SN	62
								Included			
	PS2X110-24	PS2-24-36S		PS2-45S	PE-70S	RM18S	903 INOX CREAM	RNDCVR DRAIN COVER		1145 1145SN	63
								Included			

Sinks and Accessories

Sinks and Accessories

MODEL NO.	BOTTOM GRID	BOTTOM GRID	CUTTING BOARD	COLANDER	ROLLER MAT	ACCESS #1	ACCESS #2	ACCESS #3	STRAINER BASKET	PAGE NO.
PS2X110-24-12	PS2-24-36S		PS2-45S	PE-70S	RM18S	903 INOX CREAM	RNDCVR DRAIN COVER		1145 1145SN	63
PS2X110-27	PS2-27-36S		PS2-45S	PE-70S	RM18S	903 INOX CREAM	RNDCVR DRAIN COVER		1145 1145SN	64
PS2X110-30	PS2-30-36S		PS2-45S	PE-70S	RM18S	903 INOX CREAM	RNDCVR DRAIN COVER		1145 1145SN	64
PS2X110-30-12	PS2-30-36S		PS2-45S	PE-70S	RM18S	903 INOX CREAM	RNDCVR DRAIN COVER		1145 1145SN	64
PS2X110-33	PS2-33-36S		PS2-45S	PE-70S	RM18S	903 INOX CREAM	RNDCVR DRAIN COVER		1145 1145SN	65
PS2X110-33-WKC	PS2-33-36S		PS2-45S	PE-70S	RM18S	903 INOX CREAM	RNDCVR DRAIN COVER		1145 1145SN	47, 66
PS2X160-18-11	PS2-18-36S	PS2-11-36S	PS2-45S	PE-70S	RM18S	903 INOX CREAM	RNDCVR DRAIN COVER		1145 1145SN	68
PS2X120-14-14	PS2-14-36S		PS2-45S	PE-70S	RM18S	903 INOX CREAM	RNDCVR DRAIN COVER		1145 1145SN	68
PS2X120-16-16	PS2-16-36S		PS2-45S	PE-70S	RM18S	903 INOX CREAM	RNDCVR DRAIN COVER		1145 1145SN	68

MODEL NO.	BOTTOM GRID	BOTTOM GRID	CUTTING BOARD	CUTTING BOARD	COLANDER	ROLLER MAT	ACCESS #1	ACCESS #2	ACCESS #3	STRAINER BASKET	PAGE NO.
CLV110-24	CL-24-36S		PS2-45S		PE-70S	RM18S	CL-BGC DRAIN COVER	CL-WGC DRAIN COVER	CL-SSC DRAIN COVER	1145 1145SN	72
CLV110-28	CL-28-36S		PS2-45S		PE-70S	RM18S	CL-BGC DRAIN COVER	CL-WGC DRAIN COVER	CL-SSC DRAIN COVER	1145 1145SN	72
CLV110-31	CL-31-36S		PS2-45S		PE-70S	RM18S	CL-BGC DRAIN COVER	CL-WGC DRAIN COVER	CL-SSC DRAIN COVER	1145 1145SN	72
CLV120-33	CL-14-36S		PS2-45S		PE-70S	RM18S	CL-BGC DRAIN COVER	CL-WGC DRAIN COVER	CL-SSC DRAIN COVER	1145 1145SN	73
PTX110-14	PT14-36S		SP-40S/PT-40S	PT-41S	PE-70S	UV-36RM	PKGCVR DRAIN COVER			1145 1145SN	76
PTX110-17	PT17-36S		SP-40S/PT-40S	PT-41S	PE-70S	UV-36RM	PKGCVR DRAIN COVER	PT14-31S SHELF GRID		1145 1145SN	76
PTX110-20	PT20-36S		SP-40S/PT-40S	PT-41S	PE-70S	UV-36RM	PKGCVR DRAIN COVER	PT14-31S SHELF GRID		1145 1145SN	76
PTX110-22	PT22-36S		SP-40S/PT-40S	PT-41S	PE-70S	UV-36RM	PKGCVR DRAIN COVER	PT14-31S SHELF GRID		1145 1145SN	77
PTX110-25	PT25-36S		SP-40S/PT-40S	PT-41S	PE-70S	UV-36RM	PKGCVR DRAIN COVER	PT14-31S SHELF GRID		1145 1145SN	77

Sinks and Accessories

	MODEL NO.	BOTTOM GRID	BOTTOM GRID	CUTTING BOARD	CUTTING BOARD	COLANDER	ROLLER MAT	ACCESS #1	ACCESS #2	ACCESS #3	ACCESS #4	STRAINER BASKET	PAGE NO.
PESCARA	PTX110-28	PT28-36S		SP-40S/PT-40S	PT-41S	PE-70S	UV-36RM	PKGCVR DRAIN COVER	PT14-31S SHELF GRID			1145 1145SN	78
	PTX110-31	PT31-36S		SP-40S/PT-40S	PT-41S	PE-70S	UV-36RM	PKGCVR DRAIN COVER	PT14-31S SHELF GRID			1145 1145SN	78
	PTX110-31-WKC	PT31-36S		SP-40S/PT-40S	PT-41S	PE-70S	UV-36RM	PKGCVR DRAIN COVER	PT14-31S SHELF GRID	903 INOX CREAM		1145	48, 79
	PTX160-31	PT14-36S	PT17-36S	SP-40S/PT-40S	PT-41S	PE-70S	UV-36RM	PKGCVR DRAIN COVER	PT14-31S SHELF GRID			1145 1145SN	80
	PTX160-37	PT14-36S	PT22-36S	SP-40S/PT-40S	PT-41S	PE-70S	UV-36RM	PKGCVR DRAIN COVER	PT14-31S SHELF GRID			1145 1145SN	80
	PTX160-40	PT17-36S	PT22-36S	SP-40S/PT-40S	PT-41S	PE-70S	UV-36RM	PKGCVR DRAIN COVER	PT14-31S SHELF GRID			1145 1145SN	80
ORCA 2.0	OR2X110-S	OC2-36S			OC2-45SP			RNDCLR DRAIN COVER	OC2-31S-RH SHELF GRID	OC2-50C WIRE BASKET	903 INOX CREAM	1145	84
	OR2X110-WKC	OC2-36S			OC2-45SP			RNDCLR DRAIN COVER	OC2-31S-RH SHELF GRID	OC2-50C WIRE BASKET	903 INOX CREAM	1145	49, 85

Sinks and Accessories

	MODEL NO.	BOTTOM GRID	ACCESS #1	ACCESS #2	ACCESS #3	ACCESS #4	ACCESS #5	ACCESS #6	STRAINER BASKET	PAGE NO.
PRESTIGE	PCX1102109	PR-36S		UV-36RM	903 INOX CREAM	AIUS100 ACCESSORY KIT	AIUS200 ACCESSORY KIT	AIUS300 ACCESSORY KIT	1145 1145SN	87
	PRX11021	PR-36S	PR-31S SHELF GRID	UV-36RM	903 INOX CREAM	AIUS100 ACCESSORY KIT	AIUS200 ACCESSORY KIT	AIUS300 ACCESSORY KIT	1145 1145SN	87
REGATTA	RGX160	RG-36S-RH RG-36S	903 INOX CREAM			AIUS100 ACCESSORY KIT	AIUS200 ACCESSORY KIT	AIUS300 ACCESSORY KIT	1145 1145SN	89
CUBE	CUX11015	CU15-36S				AIUS100 ACCESSORY KIT	AIUS200 ACCESSORY KIT	AIUS300 ACCESSORY KIT	1145 1145SN	92
	CUX11019	CU19-36S				AIUS100 ACCESSORY KIT	AIUS200 ACCESSORY KIT	AIUS300 ACCESSORY KIT	1145 1145SN	92
	CUX11021	CU21-36S				AIUS100 ACCESSORY KIT	AIUS200 ACCESSORY KIT	AIUS300 ACCESSORY KIT	1145 1145SN	92
	CUX11023	CU23-36S				AIUS100 ACCESSORY KIT	AIUS200 ACCESSORY KIT	AIUS300 ACCESSORY KIT	1145 1145SN	93
	CUX11025	CU25-36S				AIUS100 ACCESSORY KIT	AIUS200 ACCESSORY KIT	AIUS300 ACCESSORY KIT	1145 1145SN	93
	CUX11027	CU27-36S				AIUS100 ACCESSORY KIT	AIUS200 ACCESSORY KIT	AIUS300 ACCESSORY KIT	1145 1145SN	94
	CUX11030	CU30-36S				AIUS100 ACCESSORY KIT	AIUS200 ACCESSORY KIT	AIUS300 ACCESSORY KIT	1145 1145SN	94

Sinks and Accessories

	MODEL NO.	BOTTOM GRID	BOTTOM GRID	ACCESS #1	ACCESS #2	ACCESS #3	ACCESS #4	STRAINER BASKET	PAGE NO.
CUBE	CUX11030-WKC	CU30-36S			AIUS300 ACCESSORY KIT			1145	50, 95
		Included			Included			Included	
	CUX16024	CU10-36S	CU13-36S		AIUS100 ACCESSORY KIT	AIUS200 ACCESSORY KIT	AIUS300 ACCESSORY KIT	1145 1145SN	96
	CUX160	CU11-36S	CU18-36S		AIUS100 ACCESSORY KIT	AIUS200 ACCESSORY KIT	AIUS300 ACCESSORY KIT	1145 1145SN	96
	CUX120	CU15-36S			AIUS100 ACCESSORY KIT	AIUS200 ACCESSORY KIT	AIUS300 ACCESSORY KIT	1145 1145SN	96
	CUX16032	CU13-36S	CU17-36S		AIUS100 ACCESSORY KIT	AIUS200 ACCESSORY KIT	AIUS300 ACCESSORY KIT	1145 1145SN	97
CUBEADA	CUX11021-ADA	CU21-36S			AIUS100 ACCESSORY KIT	AIUS200 ACCESSORY KIT	AIUS300 ACCESSORY KIT	1145 1145SN	98
	CUX11027-ADA	CU27-36S			AIUS100 ACCESSORY KIT	AIUS200 ACCESSORY KIT	AIUS300 ACCESSORY KIT	1145 1145SN	98
GRANDE	GDX11012	GD12-36S		903 INOX CREAM	AIUS100 ACCESSORY KIT	AIUS200 ACCESSORY KIT	AIUS300 ACCESSORY KIT	1145 1145SN	101
	GDX11015	GD15-36S		903 INOX CREAM	AIUS100 ACCESSORY KIT	AIUS200 ACCESSORY KIT	AIUS300 ACCESSORY KIT	1145 1145SN	101
	GDX11018	GD18-36S		903 INOX CREAM	AIUS100 ACCESSORY KIT	AIUS200 ACCESSORY KIT	AIUS300 ACCESSORY KIT	1145 1145SN	101

Sinks and Accessories

	MODEL NO.	BOTTOM GRID	BOTTOM GRID	ACCESS #1	ACCESS #2	ACCESS #3	ACCESS #4	STRAINER BASKET	PAGE NO.
GRANDE	GDX11023	BGA2317S		903 INOX CREAM	AIUS100 ACCESSORY KIT	AIUS200 ACCESSORY KIT	AIUS300 ACCESSORY KIT	1145 1145SN	102
	GDX11028	BG90S		903 INOX CREAM	AIUS100 ACCESSORY KIT	AIUS200 ACCESSORY KIT	AIUS300 ACCESSORY KIT	1145 1145SN	102
	GDX11031	BGA3117S		903 INOX CREAM	AIUS100 ACCESSORY KIT	AIUS200 ACCESSORY KIT	AIUS300 ACCESSORY KIT	1145 1145SN	102
	GDX16028RH	GD12-36S	GD15-36S	903 INOX CREAM	AIUS100 ACCESSORY KIT	AIUS200 ACCESSORY KIT	AIUS300 ACCESSORY KIT	1145 1145SN	103
	GDX12031	GD15-36S		903 INOX CREAM	AIUS100 ACCESSORY KIT	AIUS200 ACCESSORY KIT	AIUS300 ACCESSORY KIT	1145 1145SN	104
	GDX16031RH			903 INOX CREAM	AIUS100 ACCESSORY KIT	AIUS200 ACCESSORY KIT	AIUS300 ACCESSORY KIT	1145 1145SN	104
ROTONDO	RBX110-S			903 INOX CREAM	UV-36RM ROLLER MAT			906	107
OUTDOOR SERIES	ODX110-2310-316	PS23-36S						1140F-316	109
		Included						Included	
	ODX110-2312-316	PS23-36S						1140F-316	109
		Included						Included	

Sinks and Accessories

Sinks and Accessories

MODEL NO.	BOTTOM GRID	CUTTING BOARD	ACCESS #1	ACCESS #2	ACCESS #3	ACCESS #4	ACCESS #5	STRAINER BASKET	PAGE NO.
MAG11020	MA-20-36S	MAC-40S	MAC-70S	PKG14-31RM ROLLER MAT	900-XXX COLORLINE STRAINER BASKET	WD-900-XXX COLORLINE DISPOSER FLANGE KIT	RNDCVR-XXX DRAIN COVER	1145 1145SN	118
MAG11023	MA-23-36S	MA2-40S	PX-70S	MA2-31RM ROLLER MAT	900-XXX COLORLINE STRAINER BASKET	WD-900-XXX COLORLINE DISPOSER FLANGE KIT	RNDCVR-XXX DRAIN COVER	1145 1145SN	118
MAG11025	MA-25-36S	MA2-40S	PX-70S	MA2-31RM ROLLER MAT	900-XXX COLORLINE STRAINER BASKET	WD-900-XXX COLORLINE DISPOSER FLANGE KIT	RNDCVR-XXX DRAIN COVER	1145 1145SN	119
MAG11028	MA-28-36S	MA2-40S	PX-70S	MA2-31RM ROLLER MAT	900-XXX COLORLINE STRAINER BASKET	WD-900-XXX COLORLINE DISPOSER FLANGE KIT	RNDCVR-XXX DRAIN COVER	1145 1145SN	120
MAG11029	MA-29-36S	MAC-40S	MAC-70S	PKG14-31RM ROLLER MAT	900-XXX COLORLINE STRAINER BASKET	WD-900-XXX COLORLINE DISPOSER FLANGE KIT	RNDCVR-XXX DRAIN COVER	1145 1145SN	120
MAG11031	MA2-31-36S	MA2-40S	PX-70S	MA2-31RM ROLLER MAT	900-XXX COLORLINE STRAINER BASKET	WD-900-XXX COLORLINE DISPOSER FLANGE KIT	RNDCVR-XXX DRAIN COVER	1145 1145SN	121
MAG11031OW	MA31-36S	MA3-40S	PE-70S	MA-31-RM ROLLER MAT	900-XXX COLORLINE STRAINER BASKET	WD-900-XXX COLORLINE DISPOSER FLANGE KIT	RNDCVR-XXX DRAIN COVER	1145 1145SN	122
MAG11031OW-WKC	MA-31-36S	MA3-40S	PE-70S	MA-31-RM ROLLER MAT	900-XXX COLORLINE STRAINER BASKET	WD-900-XXX COLORLINE DISPOSER FLANGE KIT	RNDCVR-XXX DRAIN COVER	1145 1145SN	123, 139
	Included	Included	Included					Included	
MAG120144	MA-14-36S	MAC-40S	MAC-70S	PKG14-31RM ROLLER MAT	900-XXX COLORLINE STRAINER BASKET	WD-900-XXX COLORLINE DISPOSER FLANGE KIT	RNDCVR-XXX DRAIN COVER	1145 1145SN	124
MAG1601611LD	MA-11-36S MA-16-36S	MAC-40S	MAC-70S	PKG14-31RM ROLLER MAT	900-XXX COLORLINE STRAINER BASKET	WD-900-XXX COLORLINE DISPOSER FLANGE KIT	RNDCVR-XXX DRAIN COVER	1145 1145SN	124

MODEL NO.	BOTTOM GRID	CUTTING BOARD	ACCESS #1	ACCESS #2	ACCESS #3	ACCESS #4	ACCESS #5	STRAINER BASKET	PAGE NO.
MAG1601812LD	MA-12-36S MA-18-36S	MA2-40S	PX-70S	MA2-31RM ROLLER MAT	900-XXX COLORLINE STRAINER BASKET	WD-900-XXX COLORLINE DISPOSER FLANGE KIT	RNDCVR-XXX DRAIN COVER	1145 1145SN	125
MAG1201515	MA-15-36S	MA2-40S	PX-70S	MA2-31RM ROLLER MAT	900-XXX COLORLINE STRAINER BASKET	WD-900-XXX COLORLINE DISPOSER FLANGE KIT	RNDCVR-XXX DRAIN COVER	1145 1145SN	126
MAG61015				UV-36RM ROLLER MAT	900-XXX COLORLINE STRAINER BASKET	WD-900-XXX COLORLINE DISPOSER FLANGE KIT	RNDCVR-XXX DRAIN COVER	1145 1145SN	126
MAG61020	MA-20-36S	MAC-40S	MAC-70S	PKG14-31RM ROLLER MAT	900-XXX COLORLINE STRAINER BASKET	WD-900-XXX COLORLINE DISPOSER FLANGE KIT	RNDCVR-XXX DRAIN COVER	1145 1145SN	127
MAG61023	MA-23-36S	MA2-40S	PX-70S	MA2-31RM ROLLER MAT	900-XXX COLORLINE STRAINER BASKET	WD-900-XXX COLORLINE DISPOSER FLANGE KIT	RNDCVR-XXX DRAIN COVER	1145 1145SN	128
MAG61023L		MA3-40S	PE-70S	MA-17-31LRM ROLLER MAT	900-XXX COLORLINE STRAINER BASKET	WD-900-XXX COLORLINE DISPOSER FLANGE KIT	RNDCVR-XXX DRAIN COVER	1145 1145SN	128
MAG61029	MA-29-36S	MAC-40S	MAC-70S	PKG14-31RM ROLLER MAT	900-XXX COLORLINE STRAINER BASKET	WD-900-XXX COLORLINE DISPOSER FLANGE KIT	RNDCVR-XXX DRAIN COVER	1145 1145SN	129
MAG61031	MA2-31-36S	MA2-40S	PX-70S	MA2-31-RM ROLLER MAT	900-XXX COLORLINE STRAINER BASKET	WD-900-XXX COLORLINE DISPOSER FLANGE KIT	RNDCVR-XXX DRAIN COVER	1145 1145SN	130
MAG61031OW	MA31-36S	MA3-40S	PE-70S	MA-31-RM ROLLER MAT	900-XXX COLORLINE STRAINER BASKET	WD-900-XXX COLORLINE DISPOSER FLANGE KIT	RNDCVR-XXX DRAIN COVER	1145 1145SN	130











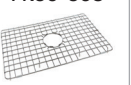



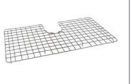

























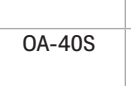

Sinks and Accessories

	MODEL NO.	BOTTOM GRID	CUTTING BOARD	ACCESS #1	ACCESS #2	ACCESS #3	ACCESS #4	ACCESS #5	STRAINER BASKET	PAGE NO.
MARIS	MAG6601611LD	MA-11-36S MA-16-36S	MAC-40S	MAC-70S	PKG14-31RM ROLLER MAT	900-XXX COLORLINE STRAINER BASKET	WD-900-XXX COLORLINE DISPOSER FLANGE KIT	RNDCVR-XXX DRAIN COVER	1145 1145SN	131
	MAG6201414	MA-14-36S	MAC-40S	MAC-70S	PKG14-31RM ROLLER MAT	900-XXX COLORLINE STRAINER BASKET	WD-900-XXX COLORLINE DISPOSER FLANGE KIT	RNDCVR-XXX DRAIN COVER	1145 1145SN	132
	MAG6601812LD	MA-12-36S MA-18-36S	MA2-40S	PX-70S COLANDER	MA2-31RM ROLLER MAT	900-XXX COLORLINE STRAINER BASKET	WD-900-XXX COLORLINE DISPOSER FLANGE KIT	RNDCVR-XXX DRAIN COVER	1145 1145SN	132
	MAG6201515	MA-15-36S	MA2-40S	PX-70S COLANDER	MA2-31RM ROLLER MAT	900-XXX COLORLINE STRAINER BASKET	WD-900-XXX COLORLINE DISPOSER FLANGE KIT	RNDCVR-XXX DRAIN COVER	1145 1145SN	133
MARIS ADA	MAG11023ADA	MAA-23-36S	MA2-40S	PX-70S COLANDER	MA2-31RM ROLLER MAT	900-XXX COLORLINE STRAINER BASKET	WD-900-XXX COLORLINE DISPOSER FLANGE KIT	RNDCVR-XXX DRAIN COVER	1145 1145SN	134
	MAG61023ADA	MAA-23-36S	MA2-40S	PX-70S COLANDER	MA2-31RM ROLLER MAT	900-XXX COLORLINE STRAINER BASKET	WD-900-XXX COLORLINE DISPOSER FLANGE KIT	RNDCVR-XXX DRAIN COVER	1145 1145SN	134
PEAK	PKG11014	PKG14-36RM			PKG14-31RM ROLLER MAT	900-XXX COLORLINE STRAINER BASKET	WD-900-XXX COLORLINE DISPOSER FLANGE KIT	PKGCVR DRAIN COVER	1145 1145SN	142
	PKG11020	PKG20-36RM			PKG14-31RM ROLLER MAT	900-XXX COLORLINE STRAINER BASKET	WD-900-XXX COLORLINE DISPOSER FLANGE KIT	PKGCVR DRAIN COVER	1145 1145SN	142
	PKG11031	PKG31-36RM	PG-40S		PKG18-31RM ROLLER MAT	900-XXX COLORLINE STRAINER BASKET	WD-900-XXX COLORLINE DISPOSER FLANGE KIT	PKGCVR DRAIN COVER	1145 1145SN	143

Sinks and Accessories

	MODEL NO.	BOTTOM GRID	CUTTING BOARD	ACCESS #1	ACCESS #2	ACCESS #3	ACCESS #4	ACCESS #5	STRAINER BASKET	PAGE NO.
PEAK	PKG11031-WKC	PKG31-36RM	PG-40S	PKG18-31RM SHELF ROLLER MAT		900-XXX COLORLINE STRAINER BASKET	WD-900-XXX COLORLINE DISPOSER FLANGE KIT	PKGCVR DRAIN COVER	1145	138, 144
	PKG160LD	PKG12-36RM PKG17-36RM	PG-40S	PKG18-31RM SHELF ROLLER MAT		900-XXX COLORLINE STRAINER BASKET	WD-900-XXX COLORLINE DISPOSER FLANGE KIT	PKGCVR DRAIN COVER	1145 1145SN	145
ELLIPSE	ELG11022	ELG22-36S		UV-36RM ROLLER MAT	AIUS100 & 200 ACCESSORY KITS	AIUS300 ACCESSORY KIT	900-XXX COLORLINE STRAINER BASKET	WD-900-XXX COLORLINE DISPOSER FLANGE KIT	1145 1145SN	148
	ELG120	ELG14-36S		UV-36RM ROLLER MAT	AIUS100 & 200 ACCESSORY KITS	AIUS300 ACCESSORY KIT	900-XXX COLORLINE STRAINER BASKET	WD-900-XXX COLORLINE DISPOSER FLANGE KIT	1145 1145SN	148
	ELG160	ELG16-36S		UV-36RM ROLLER MAT	AIUS100 & 200 ACCESSORY KITS	AIUS300 ACCESSORY KIT	900-XXX COLORLINE STRAINER BASKET	WD-900-XXX COLORLINE DISPOSER FLANGE KIT	1145 1145SN	149
	ESCH25229-1	FBGG1914			AIUS100 & 200 ACCESSORY KITS	AIUS300 ACCESSORY KIT	900-XXX COLORLINE STRAINER BASKET	WD-900-XXX COLORLINE DISPOSER FLANGE KIT	1145 1145SN	150
	EDDB33229-1	FBGG1114			AIUS100 & 200 ACCESSORY KITS	AIUS300 ACCESSORY KIT	900-XXX COLORLINE STRAINER BASKET	WD-900-XXX COLORLINE DISPOSER FLANGE KIT	1145 1145SN	150
	EDOX332291	FBGG1014		FBGG1316 BOTTOM GRID	AIUS100 & 200 ACCESSORY KITS	AIUS300 ACCESSORY KIT	900-XXX COLORLINE STRAINER BASKET	WD-900-XXX COLORLINE DISPOSER FLANGE KIT	1145 1145SN	151

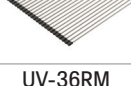
Sinks and Accessories

	MODEL NO.	BOTTOM GRID	BOTTOM GRID	CUTTING BOARD	ACCESS #1	ACCESS #2	STRAINER BASKET	PAGE NO.
FARM HOUSE	FHK710-30WH 	FK30-36S 		OA-40S 			1145 1145SN 	158
	FHK710-33WH 	FK33-36S 		OA-40S 			1145 1145SN 	158
	FHK710-36WH 	FK36-36S 		OA-40S 			1145 1145SN 	158
MANOR HOUSE	MHK110-20WH 			OA-40S 			1145 1145SN 	162
	MHK110-24WH 	MK24-36C 		OA-40S 			1145 1145SN 	162
	MHK110-28WH 	MK28-36C 		OA-40S 			1145 1145SN 	162
	MHK720-31WH 			OA-40S 			1145 1145SN 	163
	MHK720-35WH 			OA-40S 			1145 1145SN 	163
	CCK110-13WH 	CK13-36C 		OA-40S 	UV-36RM ROLLER MAT 			1145 1145SN 
CISTERNA	CCK110-15WH 			OA-40S 	UV-36RM ROLLER MAT 		1145 1145SN 	166
	CCK110-19WH 	CK19-36C 		OA-40S 	UV-36RM ROLLER MAT 		1145 1145SN 	166



ACCESSORY COMPONENT	AIUS100	AIUS200	AIUS300
TELESCOPIC BRIDGE 	YES	YES	YES
SMALL COLANDER 		YES	YES
PREP BOWL 		YES	YES
BAMBOO BOWL LID 		YES	YES
SILICONE MAT 		YES	YES
BAMBOO CHOPPING BOARD 	YES	YES	YES
LARGE COLANDER 	YES		YES
STORAGE CONTAINER 			YES

ALL-IN ACCESSORY SYSTEM

12"



PKX1108
Page 54

18"



CCK110-13WH
Page 166



CUX11010-W
Page 43



GDX11012
Page 101



MAG61015
(Topmount)
Page 126



PKG11014
Page 142



PKX11013
Page 54



PTX110-14
Page 76



RBX110-S
(Topmount)
Page 107

21"



CCK110-15WH
Page 166



CUX11015
Page 92



GDX11015
Page 101



MAG61015
(Undermount)
Page 126



MHK110-20WH
Page 162



MMX11015-ANT-WKC
Page 38

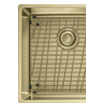

MMX11015-GLD-WKC
Page 38



PKX11016
Page 54



PS2X110-15
Page 62



PTX110-17
Page 76



RBX110-S
(Undermount)
Page 107

24"



CUX11019
Page 92



GDX11018
Page 101



MAG11020
Page 118



MAG61020
Page 127



MHK110-24WH
Page 162



PKX11018
Page 55



PS2X110-18
Page 62



PTX110-20
Page 76

27"



CCK110-19WH
Page 166



CUX11021
Page 92



CUX11021-ADA
Page 98



ESCH25229-1
Page 150



MAG61023
Page 128



MAG61023L
(Topmount)
Page 128



MAG61023ADA
Page 134



PCX1102109
Page 87



PKG11020
Page 142



PKX11021
Page 55



PRX11021
Page 87



PS2X110-21
Page 62



PTX110-22
Page 77

Minimum Cabinet Size

30"



33"



36"



Minimum Cabinet Size

36"



39"









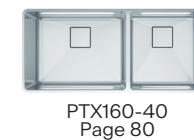

































42"













































45"



	STAINLESS STEEL	SATIN NICKEL	POLISHED CHROME	INDUSTRIAL BLACK	GOLD	ANTHRACITE	POLAR WHITE	STONE GREY	ONYX	MATTE BLACK	CHAMPAGNE	OYSTER
PULL-OUT FAUCETS			Icon ICN-PO-CHR Page 177 							Icon ICN-PO-MBK Page 177 		
	Atlas Neo ATL-PO-304 Page 186 											
	Steel STL-PO-304 Page 191 			Steel STL-PO-IBK Page 191 	Steel STL-PO-GLD Page 191 							
			Active ACT-PO-CHR Page 194 			Active ACT-PO-PWT Page 194 	Active ACT-PO-STG Page 194 	Active ACT-PO-ONY Page 194 	Active ACT-PO-MBK Page 194 	Active ACT-PO-CHA Page 194 	Active ACT-PO-OYS Page 194 	
		Smart SMA-PO-SNI Page 201 	Smart SMA-PO-CHR Page 201 									
PULL-DOWN FAUCETS		Pescara PES-PDX-SNI Page 183 	Pescara PES-PDX-CHR Page 183 									
		Pescara PES-PD-SNI Page 183 	Pescara PES-PD-CHR Page 183 							Pescara PES-PD-MBK Page 183 		
	Steel STL-PD-304 Page 190 			Steel STL-PD-IBK Page 190 	Steel STL-PD-GLD Page 190 							
			Active ACT-PD-CHR Page 194 							Active ACT-PD-MBK Page 194 		

	STAINLESS STEEL	SATIN NICKEL	POLISHED CHROME	INDUSTRIAL BLACK	GOLD	ANTHRACITE	POLAR WHITE	STONE GREY	ONYX	MATTE BLACK	CHAMPAGNE	OYSTER	
PULL-DOWN FAUCETS	Eos Neo EOS-PD-304 Page 198 			Eos Neo EOS-PD-IBK Page 198 	Eos Neo EOS-PD-GLD Page 198 	Eos Neo EOS-PD-ANT Page 198 							
										Icon ICN-SP-MBK Page 176 			
SEMI-PRO FAUCETS	Centinox CEN-SP-304 Page 179 												
	Pescara PES-SPX-304 Page 182 												
	Pescara PES-SP-304 Page 182 												
		Pescara PES-360-SNI Page 182 	Pescara PES-360-CHR Page 182 								Pescara PES-360-MBK Page 182 		
						Active ACT-SP-CHR Page 194 					Active ACT-SP-MBK Page 194 		
OUTDOOR FAUCETS	Steel STL-PD-316 Page 190 												
	Eos Neo EOS-PD-316 Page 198 												

	STAINLESS STEEL	SATIN NICKEL	POLISHED CHROME	INDUSTRIAL BLACK	GOLD	ANTHRACITE	POLAR WHITE	STONE GREY	ONYX	MATTE BLACK	CHAMPAGNE	OYSTER
COLD FILTRATION FAUCETS	Universal L UNL-FW-304 Page 208 											
	Universal J UNJ-FW-304 Page 209 		Universal J UNJ-FW-CHR Page 209 	Universal J UNJ-FW-IBK Page 209 	Universal J UNJ-FW-GLD Page 209 							
HOT FILTRATION FAUCETS	Universal L UNL-HO-304 Page 208 											
	Universal J UNJ-HO-304 Page 209 		Universal J UNJ-HO-CHR Page 209 	Universal J UNJ-HO-IBK Page 209 	Universal J UNJ-HO-GLD Page 209 							
HOT/COLD FILTRATION FAUCETS	Universal L UNL-HC-304 Page 208 											
	Universal J UNJ-HC-304 Page 209 		Universal J UNJ-HC-CHR Page 209 	Universal J UNJ-H-IBK Page 209 	Universal J UNJ-HC-GLD Page 209 							
SOAP DISPENSERS		Univesal UNI-SD-SNI Page 221 	Univesal UNI-SD-CHR Page 221 									
	Atlas ATL-SD-316 Page 221 			Atlas ATL-SD-IBK Page 221 	Atlas ATL-SD-GLD Page 221 	Atlas ATL-SD-ANT Page 221 						
		Active ACT-SD-SNI Page 221 	Active ACT-SD-CHR Page 221 			Active ACT-SD-PWT Page 221 	Active ACT-SD-STG Page 221 	Active ACT-SD-ONY Page 221 	Active ACT-SD-MBK Page 221 	Active ACT-SD-CHA Page 221 	Active ACT-SD-OYS Page 221 	

	STAINLESS STEEL	SATIN NICKEL	POLISHED CHROME	INDUSTRIAL BLACK	GOLD	ANTHRA-CITE	POLAR WHITE	STONE GREY	ONYX	MATTE BLACK	CHAM-PAGNE	OYSTER
POT FILLER	Steel STL-PF-304 Page 191 											
	Steel STL-BR-304 Page 191 			Steel STL-BR-IBK Page 191 	Steel STL-BR-GLD Page 191 							
BAR	Eos Neo EOS-BR-304 Page 199 			Eos Neo EOS-BR-IBK Page 199 	Eos Neo EOS-BR-GLD Page 199 							
	Steel STL-PR-304 Page 190 			Steel STL-PR-IBK Page 190 	Steel STL-PR-GLD Page 190 							
PREP	Eos Neo EOS-PR-304 Page 200 			Eos Neo EOS-PR-IBK Page 199 	Eos Neo EOS-PR-GLD Page 199 							

GENERAL

- Products may only be sold and advertised within North America. Franke hereby expressly prohibits the dealer from soliciting or consummating sales outside of North America without prior written consent.
- Products shall only be sold in their original packaging. Relabeling, repackaging (including the separation of bundled products or the bundling of separate products), and other alterations are not permitted.
- Sale of Franke products on the Internet shall be prohibited unless resellers apply and are approved by Franke Home Solutions North America, LLC, and execute an Authorized Internet Reseller Agreement regulating the manner in which they sell online.

ORDERING

- Once an order has been acknowledged, no changes (including additions or cancellations) will be accepted within 48 hours prior to shipping.
- Order acknowledgments are available via email. An email address must be provided to receive this benefit.
- Standard lead time for shipment is one to five (1-5) business days from receipt of order.

STANDARD PAYMENT TERMS

- Net 30 days.
- Early payment discounts are not applicable for payments via credit card.
- Franke reserves the right to charge interest and an administration fee on late payments.

PRICING

- Please refer to the electronically published price list (EPL). Orders will be priced with the prevailing price at the time the order is placed.
- Prices are subject to change without notice. Franke will attempt to provide reasonable lead time for pricing changes.

CLAIMS / CHARGE BACKS

- Damages/Shortages must be reported within ten (10) days of receipt of merchandise.
- Charge backs will not be accepted without an authorization number (RMA), provided by a Regional Sales Manager, Distributor, or Customer Service.

RETURNS

- No returns will be accepted without a return authorization number (RMA).
- Return authorization requests must be submitted through Rep/Regional Manager.
- A 25% restocking fee will be charged for ALL returns of product that was not damaged or mis-shipped.
- No returns will be accepted more than 90 days from original invoice date.
- No returns will be accepted on discontinued (DWO) or obsolete product.
- Franke reserves the right to refuse returns without reason.

FREIGHT**Pre-paid freight/Free freight allowance (FFA)**

- USD \$2,900 is the minimum order value for FFA
- All product lines, including parts, can be included in freight qualification calculations.
- All Display and Literature orders will be shipped with pre-paid freight status.

Flat Rate Shipping

- Any order shipping parcel containing standard products will ship for \$25 flat.
- Orders >150 lbs. are shipping LTL and are charged according to weight/dimension.
- Orders containing Fireclay sinks are charged USD 200 for up to 2 units and USD 350 for up to 4 units.
- Other: standard shipping rates apply for Fireclay orders greater than 4 units and any parts only orders.
- Franke reserves the right to modify these terms at any time.

Other freights terms

- Franke will attempt to fulfill requests to expedite shipping. Customers will be responsible for additional freight charges. Contact Customer Service for all expedited shipping requests.
- Drop shipment of internet orders is not available. All Internet Sales must be shipped from an Authorized Internet Reseller's location.

- Drop shipment is offered within 100 miles of customer's place of business, or within customer's state or a bordering state on wholesale orders.

BACK ORDERS

- Back order shipments will match freight qualifying status of original order.
- Back ordered product will be considered an active order unless customer requests cancellation.

FRANKE HOME SOLUTIONS WARRANTY

EFFECTIVE OCTOBER 1, 2023

In the United States, Canada and Latin America, Franke warrants the products from manufacturing defects in material and workmanship when purchased from Franke or a Franke Authorized Retailer pursuant to product-specific warranties detailed herein (each, a "Warranty" and collectively, the "Warranties"). The products must be properly installed, per company's installations instructions, in its original installation, and used in normal indoor residential kitchen applications. Any products or components which have been modified or altered, from its original intended condition will void the warranty. The Franke Warranties are limited to the original purchaser and are non-transferrable. These Warranties do not include products purchased from non-Authorized Retailers, products that are obsolete or discontinued, or products that were previous display models. All issues with installed products are considered warranty claims and not subject to the Return Policy. Franke reserves the right to inspect any product reported to be defective and the original installation prior to providing a replacement product and/or component. All decisions are final. In no situation shall the liability of Franke exceed the amount of the original purchase price.

The Warranties do not cover, and Franke shall not be liable for, any damage to products or components resulting from misuse or abuse, accidental damages, normal wear such as scuffs, scratches or finish reduction/fading; improper installation, abnormal usage, negligence, damage caused by improper maintenance or cleaning. Damage caused by impurities, corrosive chemicals or acts beyond Franke's control are not covered by any Warranty.

Franke product replacements do not include transportation, shipping, diagnosis, labor, installation, removal, disposal for any products or liability for project delays. Product replacements are not guaranteed to be exact replacements. The owner of a product is liable for any transportation and re-installation costs related to any warranty for such product. If the original product is not available at the time of the warranty claim, at Franke's option, the product replacements will be of similar size, material, and value. Any products or components which have been modified or altered, from its original intended condition will void the warranty.

The Warranties do not allow recovery of incidental or consequential damages such as loss of use, delay, property damage or other consequential damage, and Franke accepts no liability for such damages. Each Warranty is limited to the conditions set forth herein and to the applicable warranty period specified herein and is exclusive. EXCEPT FOR THE WARRANTIES SET FORTH HEREIN, FRANKE MAKES NO WARRANTY WHATSOEVER WITH RESPECT TO THE PRODUCTS, INCLUDING, BUT NOT LIMITED TO, (1) ANY WARRANTY OF MERCHANTABILITY, (2) WARRANTY OF FITNESS FOR A PARTICULAR PURPOSE, (3) WARRANTY OF TITLE, OR (4) WARRANTY AGAINST INFRINGEMENT OF INTELLECTUAL PROPERTY RIGHTS OF A THIRD PARTY, WHETHER EXPRESS OR IMPLIED BY LAW, COURSE OF DEALING, COURSE OF PERFORMANCE, USAGE OF TRADE OR OTHERWISE. LEGAL DISCLAIMER PLEASE READ CAREFULLY. Franke Home Solutions North America, LLC/Franke Kindred Canada Limited provides the above information to you as a public service to our customers. By accessing and using this information, you agree to the following and to comply with all applicable laws. If you do not agree with these terms and conditions, do not use this information. While we try to keep the information current, changes may have occurred since its creation. Contact your Regional Manager or Customer Service to verify information regarding Franke Home Solutions North America, LLC/Franke Kindred Canada programs and their use by you.

Franke Residential Stainless, Granite and Fireclay Sink Limited Lifetime Warranty:

Franke warrants that each Franke sink will be free from manufacturing defects in material and workmanship for the expected lifetime of the sink when used in standard residential indoor applications. The warranty covers sinks installed in its original installation per Franke installation instructions in residential applications using conventional or solid surface countertop. For surface coated sinks (i.e. Franke Mythos Masterpiece sinks) Franke warrants that each sink will be free of manufacturing defects in materials and workmanship for two (2) years from the original date of purchase.

Franke Residential Disposal Limited Warranty:

Franke warrants that disposers are free from manufacturing defects in material and workmanship for the period ranging from two (2) years to Limited Lifetime as documented in the annual product catalogs and/or instructions included with the products.

Franke Residential Faucet Limited Lifetime Warranty:

Franke warrants that mechanical components (body, handle and spout) in all faucets purchased after January 1, 2003, will be free of manufacturing defects for the expected lifetime of the faucet. Franke shall not be liable for any damage caused by normal wear and tear to wearable parts of the faucet. The expected useful lifetime of wearable parts is; one (1) year: aerator, o-rings; five (5) years: cartridge, hose, electrical components; ten (10) years: spray head. The wearable parts can be purchased as spare parts from Franke or their Authorized Retailers. Franke warrants the chrome finishes on Franke faucets will be free of manufacturing defect for the lifetime of the faucet; and all other finishes on Franke faucets will be free of manufacturing defects for five (5) years from the original date of purchase. Faucets purchased prior to 2003 are subject to the warranty in place at time of purchase.

Franke Residential Filtration Limited Warranty:

Franke warrants mechanical components in filtration faucets, filtration canisters, filters and filtered water temperature modification devices; heating tanks and chillers, to be free from manufacturing defects in material and workmanship for the period ranging from one (1) year to ten (10) years as documented in the annual product catalogs and/or instructions included with the products.

Franke Residential Soap Dispensers Limited Warranty:

Franke warrants that Franke soap dispensers are free from manufacturing defects in material and workmanship for a period of five (5) years from the date of purchase. Such warranty does not cover damage caused by the use of aggressive soaps or chemicals.

Franke Residential Accessories Limited Warranty:

Franke warrants that Franke accessories, including, but not limited to bottom grids, shelves, waste kits, colanders, chopping boards are free from manufacturing defects in material and workmanship for a period of one (1) year from the dates of original purchase.

Franke Residential Outdoor Installation Limited Warranty:

Specific Franke products noted below are engineered for outdoor applications. These products are warranted to be free from manufacturing defects in material and workmanship for outdoor installations for ten (10) years from the date of purchase. Stainless Sinks: ODX110-2310-316 and ODX110-2312-316 and Stainless Faucets: FF3352, FF3452SS, EOS-PD-316 and STL-PD-316.

This warranty supersedes all other warranties, expressed or implied. No employee, field sales representatives, or distribution persons are authorized to give any warranties on behalf of Franke Home Solutions North America, LLC or Franke Kindred Canada Limited.

To make an installed product warranty claim please contact Franke at the provided contact information below. All warranty claims must include the following for processing:

1. Proof of purchase from Franke or Franke Authorized Retailer
2. Original purchaser’s name, address (included city, state, zip), email address and phone number
3. Franke model number
4. Date of installation
5. Description of the defect
6. Photos of the defect

In the US:
 Franke Home Solutions
 Attn: Warranty Department
 800 Aviation Parkway
 Smyrna, TN 37167
 HS-Warranty.US@Franke.com

In Canada:
 Franke Home Solutions
 Attn: Warranty Department
 1000 Franke Kindred Road
 Midland, Ontario L4R 4K9
 HS-Warranty.CA@Franke.com

Legal Entities
 USA: Franke Home Solutions North America, LLC
 Canada: Franke Kindred Canada Limited

LEGAL DISCLAIMER

Please read carefully.

Franke Home Solutions North America, LLC provides the above information to you for as a public service to our customers. By accessing and using this information, you agree to the following and to comply with all applicable laws. If you do not agree with these terms and conditions, do not use this information. While we try to keep the information current, changes may have occurred since its creation. Contact your Regional Manager or Customer Service to verify information regarding Franke Home Solutions North America, LLC programs and their use by you.

Copyright and Other Intellectual Property Rights. This document and our website are protected by copyright pursuant to U.S. copyright laws, international treaties, and other copyright laws. This document and our website contains copyrighted material, trademarks, and other proprietary information of Franke Home Solutions North America, LLC and others (collectively “Proprietary Material”), which may include, but shall not be limited to: text, software, photos, video, graphics, images, music and sound. You may not modify, publish, copy, transmit, participate in the transfer or sale of, create derivative works of, or in any way exploit, in whole or in part, any Proprietary Material without the prior written authorization of Franke Home Solutions North America, LLC or the applicable rights holder.

Changes. We may change these terms and any part (or all) of the information enclosed at any time without notice. Any changes will apply to your future use, so you should contact your Regional Manager or Customer Service periodically. If you use this information after any changes to these terms, then you accept those changes.

Choice of Law. We are a Delaware limited liability company and these Terms and Conditions, and the purchase of products from Franke Home Solutions North America, LLC, shall be governed by the substantive laws of the State of Delaware, including the Uniform Commercial Code as adopted in Delaware, and the United Nations Convention on Contracts for the International Sale of Goods shall not apply. Any cause of action must be commenced within one year after the claim or cause of action arises. If a court of competent jurisdiction holds these terms and conditions or any part of them to be invalid, then that part shall be enforced to the maximum extent possible and the remainder of these terms and conditions will remain in full force and effect.

HOW TO CONTACT US

Contact Info
 Customer Service: 800-626-5771
 Customer Service: ks-customerservice.us@franke.com
 Marketing Services Email: ks-marketing@franke.com
 Mailing Address: Franke Home Solutions North America, LLC 800 Aviation Parkway Smyrna, TN 37167

Category Index

Category Index

SINKS	Page	Price	SINKS	Page	Price	SINKS	Page	Price	SINKS	Page	Price	SINKS	Page	Price
CCK110-13WH	166	\$895	ESCH25229-1	150	\$600	MAG11029-ONY	120	\$765	MAG61015-MOC	126	\$655	MAG6201414-MBK	132	\$770
CCK110-15WH	166	\$930	ESDB25229-1	150	\$600	MAG11029-OYS	120	\$765	MAG61015-ONY	126	\$655	MAG6201414-MOC	132	\$770
CCK110-19WH	166	\$1,030	ESMB25229-1	150	\$600	MAG11029-PWT	120	\$765	MAG61015-OYS	126	\$655	MAG6201414-ONY	132	\$770
CLV110-24	72	\$2,015	ESOX25229-1	150	\$600	MAG11029-SHG	120	\$765	MAG61015-PWT	126	\$655	MAG6201414-OYS	132	\$770
CLV110-28	72	\$2,155	ESQY25229-1	150	\$600	MAG11029-SLG	120	\$765	MAG61015-SHG	126	\$655	MAG6201414-PWT	132	\$770
CLV110-31	72	\$2,280	ESPW25229-1	150	\$600	MAG11031-CHA	121	\$775	MAG61015-SLG	126	\$655	MAG6201414-SHG	132	\$770
CLV120-33	73	\$2,410	ESSG25229-1	150	\$600	MAG11031-MBK	121	\$775	MAG61020-CHA	127	\$665	MAG6201414-SLG	132	\$770
CUX11010-W	43	\$2,535	ESSL25229-1	150	\$600	MAG11031-MOC	121	\$775	MAG61020-MBK	127	\$665	MAG6201515-CHA	133	\$800
CUX11015	92	\$850	FHK710-30WH	158	\$1,455	MAG11031-ONY	121	\$775	MAG61020-MOC	127	\$665	MAG6201515-MBK	133	\$800
CUX11019	92	\$895	FHK710-33WH	158	\$1,865	MAG11031OW-CHA	122	\$775	MAG61020-ONY	127	\$665	MAG6201515-MOC	133	\$800
CUX11021	92	\$990	FHK710-36WH	158	\$2,025	MAG11031OW-CHA-WKC	123,139	\$1,420	MAG61020-OYS	127	\$665	MAG6201515-ONY	133	\$800
CUX11021-ADA	98	\$990	GDX11012	101	\$750	MAG11031OW-MBK	122	\$775	MAG61020-PWT	127	\$665	MAG6201515-OYS	133	\$800
CUX11023	93	\$1,025	GDX11015	101	\$800	MAG11031OW-MBK-WKC	123,139	\$1,420	MAG61020-SHG	127	\$665	MAG6201515-PWT	133	\$800
CUX11025	93	\$1,070	GDX11018	101	\$925	MAG11031OW-MOC	122	\$775	MAG61020-SLG	127	\$665	MAG6201515-SHG	133	\$800
CUX11027	94	\$1,135	GDX11023	102	\$1,025	MAG11031OW-MOC-WKC	123,139	\$1,420	MAG61023ADA-CHA	134	\$670	MAG6201515-SLG	133	\$800
CUX11027-ADA	98	\$1,135	GDX11028	102	\$1,090	MAG11031OW-ONY	122	\$775	MAG61023ADA-MBK	134	\$670	MAG6601611LD-CHA	131	\$770
CUX11030	94	\$1,275	GDX11031	102	\$1,180	MAG11031OW-ONY-WKC	123,139	\$1,420	MAG61023ADA-MOC	134	\$670	MAG6601611LD-MBK	131	\$770
CUX11030-WKC	50,95	\$1,875	GDX12031	104	\$1,345	MAG11031OW-OYS	122	\$775	MAG61023ADA-ONY	134	\$670	MAG6601611LD-MOC	131	\$770
CUX120	96	\$1,410	GDX16028RH	103	\$1,310	MAG11031OW-OYS-WKC	123,139	\$1,420	MAG61023ADA-OYS	134	\$670	MAG6601611LD-ONY	131	\$770
CUX160	96	\$1,410	GDX16031RH	104	\$1,365	MAG11031OW-PWT	122	\$775	MAG61023ADA-PWT	134	\$670	MAG6601611LD-OYS	131	\$770
CUX16021-W	43	\$3,350	MAG11020-CHA	118	\$680	MAG11031OW-PWT-WKC	123,139	\$1,420	MAG61023ADA-SHG	134	\$670	MAG6601611LD-PWT	131	\$770
CUX16024	96	\$1,135	MAG11020-MBK	118	\$680	MAG11031OW-SHG	122	\$775	MAG61023ADA-SLG	134	\$670	MAG6601611LD-SHG	131	\$770
CUX16032	97	\$1,460	MAG11020-MOC	118	\$680	MAG11031OW-SHG-WKC	123,139	\$1,420	MAG61023L-CHA	128	\$750	MAG6601611LD-SLG	131	\$770
EDCH33229-1	150	\$665	MAG11020-ONY	118	\$680	MAG11031OW-SLG	122	\$775	MAG61023L-MBK	128	\$750	MAG6601812LD-CHA	132	\$800
EDDB33229-1	150	\$665	MAG11020-OYS	118	\$680	MAG11031OW-SLG-WKC	123,139	\$1,420	MAG61023L-MOC	128	\$750	MAG6601812LD-MBK	132	\$800
EDMB33229-1	150	\$665	MAG11020-PWT	118	\$680	MAG11031-OYS	121	\$775	MAG61023L-ONY	128	\$750	MAG6601812LD-MOC	132	\$800
EDOX33229-1	150	\$665	MAG11020-SHG	118	\$680	MAG11031-PWT	121	\$775	MAG61023L-OYS	128	\$750	MAG6601812LD-ONY	132	\$800
EDPW33229-1	150	\$665	MAG11020-SLG	118	\$680	MAG11031-SHG	121	\$775	MAG61023L-PWT	128	\$750	MAG6601812LD-OYS	132	\$800
EDSG33229-1	150	\$665	MAG11023ADA-CHA	134	\$695	MAG11031-SLG	121	\$775	MAG61023L-SHG	128	\$750	MAG6601812LD-PWT	132	\$800
EDSL33229-1	150	\$665	MAG11023ADA-MBK	134	\$695	MAG1201414-CHA	124	\$810	MAG61023L-SLG	128	\$750	MAG6601812LD-SHG	132	\$800
ELG11022CHA	148	\$675	MAG11023ADA-MOC	134	\$695	MAG1201414-MBK	124	\$810	MAG61023-CHA	128	\$670	MAG6601812LD-SLG	132	\$800
ELG11022MBK	148	\$675	MAG11023ADA-ONY	134	\$695	MAG1201414-MOC	124	\$810	MAG61023-MBK	128	\$670	MHK110-20WH	162	\$735
ELG11022MOC	148	\$675	MAG11023ADA-OYS	134	\$695	MAG1201414-ONY	124	\$810	MAG61023-MOC	128	\$670	MHK110-24WH	162	\$975
ELG11022ONY	148	\$675	MAG11023ADA-PWT	134	\$695	MAG1201414-OYS	124	\$810	MAG61023-ONY	128	\$670	MHK110-28WH	162	\$1,090
ELG11022OYS	148	\$675	MAG11023ADA-SHG	134	\$695	MAG1201414-PWT	124	\$810	MAG61023-OYS	128	\$670	MHK720-31WH	163	\$1,205
ELG11022PWT	148	\$675	MAG11023ADA-SLG	134	\$695	MAG1201414-SHG	124	\$810	MAG61023-PWT	128	\$670	MHK720-35WH	163	\$1,675
ELG11022SHG	148	\$675	MAG11023-CHA	118	\$695	MAG1201414-SLG	124	\$810	MAG61023-SHG	128	\$670	MMX11015-ANT-WKC	38	\$2,700
ELG11022SHG	148	\$675	MAG11023-MBK	118	\$695	MAG1201515-CHA	126	\$840	MAG61023-SLG	128	\$670	MMX11015-GLD-WKC	38	\$2,700
ELG11022SLG	148	\$790	MAG11023-MOC	118	\$695	MAG1201515-MBK	126	\$840	MAG61029-CHA	129	\$725	MMX11027-ANT-WKC	38	\$3,750
ELG120CHA	148	\$790	MAG11023-ONY	118	\$695	MAG1201515-MOC	126	\$840	MAG61029-MBK	129	\$725	MMX11027-GLD-WKC	39	\$3,750
ELG120MBK	148	\$790	MAG11023-OYS	118	\$695	MAG1201515-ONY	126	\$840	MAG61029-MOC	129	\$725	ODX110-2310-316	109	\$1,135
ELG120MOC	148	\$790	MAG11023-OYS	118	\$695	MAG1201515-OYS	126	\$840	MAG61029-MOC	129	\$725	ODX110-2312-316	109	\$1,205
ELG120ONY	148	\$790	MAG11023-PWT	118	\$695	MAG1201515-PWT	126	\$840	MAG61029-ONY	129	\$725	OR2X110-S	84	\$1,470
ELG120OYS	148	\$790	MAG11023-SHG	118	\$695	MAG1201515-SHG	126	\$840	MAG61029-OYS	129	\$725	OR2X110-WKC	49,85	\$2,155
ELG120PWT	148	\$790	MAG11023-SLG	118	\$695	MAG1201515-SLG	126	\$840	MAG61029-PWT	129	\$725	PCX1102109	87	\$925
ELG120SHG	148	\$790	MAG11025-CHA	119	\$720	MAG1601611LD-CHA	124	\$810	MAG61029-SHG	129	\$725	PKG11014CHA	142	\$675
ELG120SLG	148	\$790	MAG11025-MBK	119	\$720	MAG1601611LD-MBK	124	\$810	MAG61029-SLG	129	\$725	PKG11014MBK	142	\$675
ELG160CHA	149	\$790	MAG11025-MOC	119	\$720	MAG1601611LD-MOC	124	\$810	MAG61031-CHA	130	\$750	PKG11014MOC	142	\$675
ELG160MBK	149	\$790	MAG11025-ONY	119	\$720	MAG1601611LD-ONY	124	\$810	MAG61031-MBK	130	\$750	PKG11014ONY	142	\$675
ELG160MOC	149	\$790	MAG11025-OYS	119	\$720	MAG1601611LD-ONY	124	\$810	MAG61031-MOC	130	\$750	PKG11014OYS	142	\$675
ELG160ONY	149	\$790	MAG11025-PWT	119	\$720	MAG1601611LD-OYS	124	\$810	MAG61031-ONY	130	\$750	PKG11014PWT	142	\$675
ELG160OYS	149	\$790	MAG11025-SHG	119	\$720	MAG1601611LD-PWT	124	\$810	MAG61031OW-CHA	130	\$750	PKG11014SHG	142	\$675
ELG160PWT	149	\$790	MAG11025-SLG	119	\$720	MAG1601611LD-SHG	124	\$810	MAG61031OW-MBK	130	\$750	PKG11014SHG	142	\$675
ELG160SHG	149	\$790	MAG11028-CHA	120	\$745	MAG1601611LD-SLG	124	\$810	MAG61031OW-MOC	130	\$750	PKG11014SLG	142	\$675
ELG160SLG	149	\$790	MAG11028-MBK	120	\$745	MAG1601812LD-CHA	125	\$840	MAG61031OW-MOC	130	\$750	PKG11020CHA	142	\$815
EOCH33229-1	151	\$675	MAG11028-MOC	120	\$745	MAG1601812LD-MBK	125	\$840	MAG61031OW-OYS	130	\$750	PKG11020MBK	142	\$815
EODB33229-1	151	\$675	MAG11028-ONY	120	\$745	MAG1601812LD-MOC	125	\$840	MAG61031OW-PWT	130	\$750	PKG11020MOC	142	\$815
EOMB33229-1	151	\$675	MAG11028-OYS	120	\$745	MAG1601812LD-ONY	125	\$840	MAG61031OW-SHG	130	\$750	PKG11020ONY	142	\$815
EOOX33229-1	151	\$675	MAG11028-PWT	120	\$745	MAG1601812LD-OYS	125	\$840	MAG61031OW-SLG	130	\$750	PKG11020OYS	142	\$815
EOOY33229-1	151	\$675	MAG11028-SHG	120	\$745	MAG1601812LD-PWT	125	\$840	MAG61031OW-SLG	130	\$750	PKG11020PWT	142	\$815
EOPW33229-1	151	\$675	MAG11028-SLG	120	\$745	MAG1601812LD-SHG	125	\$840	MAG61031-PWT	130	\$750	PKG11020SHG	142	\$815
EOSG33229-1	151	\$675	MAG11029-CHA	120	\$765	MAG1601812LD-SLG	125	\$840	MAG61031-SHG	130	\$750	PKG11020SLG	142	\$815
EOSL33229-1	151	\$675	MAG11029-MBK	120	\$765	MAG1601812LD-SHG	125	\$840	MAG61031-SHG	130	\$750	PKG11031CHA	143	\$955
			MAG11029-MOC	120	\$765	MAG61015-CHA	126	\$655	MAG6201414-CHA	132	\$770	PKG11031CHA-WKC	138,144	\$1,605
						MAG61015-MBK	126	\$655						

Category Index

Category Index

FAUCETS	Page	Price	FILTRATION	Page	Price	ACCESSORIES	Page	Price	ACCESSORIES	Page	Price	ACCESSORIES	Page	Price	ACCESSORIES	Page	Price
ACT-PD-CHR	194	\$705	CT-200	210	\$1,450				CU23-36S	93	\$205	OC2-36S	49, 84, 85	\$295	RNDCVR	43, 47, 49, 63, 65, 66,	\$120
ACT-PD-MBK	194	\$855	FRC06	211	\$105	1145	43, 46, 47, 48, 49, 50, 55,	\$80	CU25-36S	93	\$210	OC2-45SP	49, 84, 85	\$450		69, 84, 85, 119, 121, 122,	
ACT-PO-CHA	194	\$855	FRC06-2PK	211	\$195		57, 58, 63, 65, 66, 69, 73, 77,		CU27-36S	94, 99	\$220	OC2-50C	49, 84, 85	\$220		123, 125, 127, 129, 131,	
ACT-PO-CHR	194	\$705	FRC09	212	\$90		78, 79, 81, 84, 85, 87, 89, 93,		CU30-36S	50, 94, 95	\$225	PE-70S	47, 48, 63, 65, 66, 69,	\$290		133, 135, 233	
ACT-PO-MBK	121, 122, 123, 125, 129, 131, 133, 135, 194	\$855	FRCNSTR	211	\$445		94, 95, 97, 99, 103, 104, 119,		CU-40K	43	\$325		73, 77, 78, 79, 81, 121,		RNDCVR-CHA	119, 121, 122, 123, 125, 127,	\$65
			FRCNSTR100	210	\$280		121, 122, 123, 125, 127, 129,		CU-40P	43	\$135		122, 123, 129, 131, 139			129, 131, 133, 135, 233	
			FRCNSTR-DUO-1	211	\$500		131, 133, 135, 138, 139, 143,		CU-40S	43	\$200	PG-40S	138, 143, 144, 145	\$290	RNDCVR-MBK	119, 121, 122, 123, 125, 127,	\$65
ACT-PO-ONY	194	\$855	FRX02	212	\$105		144, 145, 149, 151, 159, 163,		CU-FC	43	\$270	PKG12-36RM	145	\$180		129, 131, 133, 135, 233	
ACT-PO-OYS	194	\$855	FRX02-2PK	212	\$195		167, 232		CU-GC	43	\$160	PKG14-31RM	119, 121, 125, 127, 129,	\$175	RNDCVR-MOC	119, 121, 122, 123, 125, 127,	\$65
ACT-PO-PWT	194	\$855	HT-400	210	\$600	1140F-316	109	\$115	CU-KS	43	\$135		131, 133, 143			129, 131, 133, 135, 233	
ACT-PO-SNI	194	\$855	UNJ-FW-304	66, 209	\$625	1145SN	55, 57, 63, 65, 69, 73, 77,	\$115	CUW-70S	43	\$265	PKG14-36RM	143	\$220	RNDCVR-OYS	119, 121, 122, 123, 125, 127,	\$65
ACT-PO-STG	194	\$855	UNJ-FW-CHR	209	\$600		78, 81, 87, 89, 93, 94, 97, 99,		CU-WR	43	\$175	PKG17-36RM	145	\$225		129, 131, 133, 135, 233	
ACT-SP-CHR	194	\$895	UNJ-FW-GLD	209	\$745		103, 104, 119, 121, 122, 123,		ELG14-36S	149	\$190	PKG18-31RM	138, 143, 144, 145	\$210	RNDCVR-PWT	119, 121, 122, 123, 125, 127,	\$65
ACT-SP-MBK	194	\$1,050	UNJ-FW-IBK	209	\$745		125, 127, 129, 131, 133, 135,		ELG16-36S	149	\$200	PKG20-36RM	143	\$245		129, 131, 133, 135, 233	
ATL-PO-304	84, 85, 186	\$810	UNJ-HC-304	209	\$755		143, 145, 149, 151, 159, 163,		ELG22-36S	149	\$210	PKG31-36RM	138, 143, 144	\$280	RNDCVR-SHG	119, 121, 122, 123, 125, 127,	\$65
CEN-SP-304	46, 55, 57, 58, 179	\$955	UNJ-HC-CHR	209	\$735		167, 232		FBGG1014	151	\$135	PKGCVR	48, 77, 78, 79, 81, 138,	\$120		129, 131, 133, 135, 233	
			UNJ-HC-GLD	209	\$890	900-CHA	119, 121, 122, 123, 125, 127,	\$100	FBGG1114	151	\$140		143, 144, 145, 233		RNDCVR-SLG	119, 121, 122, 123, 125, 127,	\$65
EOS-BR-304	107, 200	\$675	UNJ-HC-IBK	209	\$890		129, 131, 133, 135, 143, 144,		FBGG1316	151	\$150	PKXCVR	46, 55, 57, 58, 233	\$135		129, 131, 133, 135, 233	
EOS-BR-GLD	199	\$780	UNJ-HO-304	209	\$655		145, 149, 151, 232		FBGG1914	151	\$160	PR-31S	87	\$210	SP-40S	43, 48, 77, 78, 79, 81	\$90
EOS-BR-IBK	199	\$780	UNJ-HO-CHR	209	\$625	900-MBK	119, 121, 122, 123, 125, 127,	\$100	FK30-36S	159	\$340	PR-36S	87	\$210	UV-36RM	46, 47, 48, 55, 57, 58, 77,	\$225
EOS-PD-304	50, 93, 94, 95, 97, 99, 198	\$870	UNJ-HO-GLD	209	\$770		129, 131, 133, 135, 143, 144,		FK33-36S	159	\$375	PS2-11-36S	69	\$170		78, 79, 81, 87, 107, 127,	
			UNJ-HO-IBK	209	\$770		145, 149, 151, 232		FK36-36S	159	\$395	PS2-14-36S	69	\$180		149, 167, 233	
EOS-PD-316	109, 198	\$1,005	UNL-FW-304	208	\$625	900-MOC	119, 121, 122, 123, 125, 127,	\$100	GD12-36S	103	\$175	PS2-15-36S	63	\$190			
EOS-PD-ANT	198	\$1,005	UNL-HC-304	208	\$735		129, 131, 133, 135, 143, 144,		GD15-36S	103, 104	\$190	PS2-16-36S	69	\$200	WD3428ANT	39, 228	\$55
EOS-PD-GLD	198	\$1,005	UNL-HO-304	208	\$655		145, 149, 151, 232		GD18-36S	103	\$210	PS2-18-36S	63, 69	\$210	WD3428BK	228	\$45
EOS-PD-IBK	198	\$1,005				900-OYS	119, 121, 122, 123, 125, 127,	\$100	MA-11-36S	125, 131	\$180	PS2-21-36S	63	\$250	WD3428C	228	\$45
EOS-PR-304	199	\$785	SOAP DISPENSERS				129, 131, 133, 135, 143, 144,		MA-12-36S	125, 133	\$190	PS2-24-36S	63	\$265	WD3428GLD	39, 228	\$55
EOS-PR-GLD	199	\$960	ACT-SD-CHA	195, 221	\$200		145, 149, 151, 232		MA-14-36S	125, 133	\$200	PS2-27-36S	65	\$290	WD3428SN	228	\$45
EOS-PR-IBK	199	\$960	ACT-SD-CHR	195, 221	\$160	900-PWT	119, 121, 122, 123, 125, 127,	\$100	MA-15-36S	127, 133	\$210	PS2-30-36S	65	\$340	WD-900-CHA	119, 121, 122, 123, 125,	\$115
ICN-PO-CHR	63, 65, 69, 177	\$1,050	ACT-SD-MBK	195, 221	\$200		129, 131, 133, 135, 143, 144,		MA-16-36S	125, 131	\$225	PS2-33-36S	47, 65, 66	\$365		127, 129, 131, 133, 135,	
ICN-PO-MBK	73, 143, 144, 145, 177	\$1,260	ACT-SD-ONY	195, 221	\$200		145, 149, 151, 232		MA-17-31LRM	129	\$190	PS23-36S	109	\$310		143, 144, 145, 149, 151,	
			ACT-SD-OYS	195, 221	\$200	900-SHG	119, 121, 122, 123, 125, 127,	\$100	MA-18-36S	125, 133	\$235	PS2-45S	47, 63, 65, 66, 69, 73	\$290	WD-900-MBK	119, 121, 122, 123, 125,	\$115
			ACT-SD-PWT	195, 221	\$200		129, 131, 133, 135, 143, 144,		MA-20-36S	127	\$245	PT14-31S	48, 77, 78, 79, 81	\$190		127, 129, 131, 133, 135,	
			ACT-SD-SNI	195, 221	\$200		145, 149, 151, 232		MA2-31-36S	121, 131	\$310	PT14-36S	77, 81	\$190		143, 144, 145, 149, 151,	
			ACT-SD-STG	195, 221	\$200	900-SLG	119, 121, 122, 123, 125, 127,	\$100	MA2-31RM	119, 121, 125, 127, 129, 131,	\$190	PT17-36S	77, 81	\$200		229, 232	
			ATL-SD-316	186, 221	\$315		129, 131, 133, 135, 143, 144,			133, 135		PT20-36S	77	\$205	WD-900-MOC	119, 121, 122, 123, 125,	\$115
			ATL-SD-ANT	186, 221	\$315		145, 149, 151, 232		MA-20-36S	119	\$245	PT22-36S	77, 81	\$210		127, 129, 131, 133, 135,	
			ATL-SD-GLD	186, 221	\$315	900W	232	\$80	MA-23-36S	119, 129	\$255	PT25-36S	77	\$220		143, 144, 145, 149, 151,	
			ATL-SD-IBK	186, 221	\$315	AIUS100	87, 89, 93, 94, 97, 99, 103,	\$280	MA2-40S	119, 121, 125, 127, 129, 131,	\$225	PT28-36S	78	\$225		229, 232	
			UNI-SD-CHR	221	\$375		104, 149, 151, 219			133, 135		PT31-36S	48, 78, 79	\$240	WD-900-OYS	119, 121, 122, 123, 125,	\$115
			UNI-SD-SNI	221	\$450	AIUS200	87, 89, 93, 94, 97, 99, 103,	\$350	MA-25-36S	119	\$265	PT-40S	48, 77, 78, 79, 81	\$280		127, 129, 131, 133, 135,	
			DISPOSERS				104, 149, 151, 219		MA-28-36S	121, 129	\$285	PT-41S	48, 77, 78, 79, 81	\$265		143, 144, 145, 149, 151,	
			FWDS100	224	\$550	AIUS300	87, 89, 93, 94, 97, 99, 103,	\$420	MA-29-36S	122, 123, 131, 139	\$310	PX-13S	55	\$190		229, 232	
			FWDS125	224	\$670		104, 149, 151, 219		MA-31-36S	122, 123, 131, 139	\$310	PX-16S	55	\$200	WD-900-PWT	119, 121, 122, 123, 125,	\$115
			FWDS50	225	\$210	BG90S	103	\$185	MA-31RM	121, 122, 123, 131	\$190	PX-18S	55	\$210		127, 129, 131, 133, 135,	
			FWDS75	224	\$400	BGA3117S	103	\$200	MA3-40S	121, 122, 123, 129, 131, 139	\$225	PX-21S	55, 57	\$250		143, 144, 145, 149, 151,	
			FWDS75BF	225	\$500	BGA2317S	103	\$175				PX-25S	57	\$265		229, 232	
						CK13-36C	167	\$280	MAA-23-36S	135	\$255	PX-28S	46, 57, 58	\$280	WD-900-SHG	119, 121, 122, 123, 125,	\$115
						CK19-36C	167	\$310	MAC-40S	119, 121, 125, 127, 129, 131,	\$225	PX-40S	46, 55, 57, 58, 119,	\$290		127, 129, 131, 133, 135,	
						CL-14-36S	73	\$210		133		PX-70S	46, 55, 57, 58, 119,	\$280		143, 144, 145, 149, 151,	
						CL-24-36S	73	\$210	MAC-70S	119, 121, 125, 127, 129, 131, 133	\$255		121, 125, 127, 129, 131,		WD-900-SLG	119, 121, 122, 123, 125,	\$115
						CL-28-36S	73	\$225	MK24-36C	163	\$290	RG-36S	89	\$210		127, 129, 131, 133, 135,	
						CL-31-36S	73	\$240	MK28-36C	163	\$325	RG-36S-RH	89	\$210		229, 232	
						CL-BGC	73	\$190	MM15-36S-ANT	39	\$255	RM18S	63, 65, 66, 69, 73	\$210		229, 232	
						CL-SSC	73	\$160	MM15-36S-GLD	39	\$255				WD9088	228	\$170
						CL-WGC	73	\$190	MM27-36S-ANT	39	\$400				WDFLANGE-ANT	39, 228	\$140
			903	46, 47, 48, 49, 55, 57, 58,	\$50	CU10-36S	97	\$145	MM27-36S-GLD	39	\$400				WDFLANGE-CH	228	\$95
				63, 65, 66, 69, 79, 84, 85,		CU11-36S	97	\$155	MM-31RM-ANT	39	\$375				WDFLANGE-EX-SN	228	\$95
				87, 89, 103, 104, 107, 233		CU13-36S	97	\$160	MM-31RM-GLD	39	\$375						

Alphabetical Index

PRODUCT NO.	Page	Price	PRODUCT NO.	Page	Price	PRODUCT NO.	Page	Price	PRODUCT NO.	Page	Price	PRODUCT NO.	Page	Price	PRODUCT NO.	Page	Price
903	46, 47, 48, 49, 55, 57, 58, 63, 65, 66, 69, 79, 84, 85, 87, 89, 103, 104, 107, 233	\$50	ACT-SD-STG	195, 221	\$200	CUX11027	94	\$1,135	EOSG33229-1	151	\$675	MA-29-36S	121, 129	\$295	MAG11029-SLG	120	\$765
906	107, 232	\$100	ACT-SP-CHR	194	\$895	CUX11027-ADA	98	\$1,135	EOSL33229-1	151	\$675	MA-31-36S	122, 123, 131, 139	\$310	MAG11031-CHA	121	\$775
1145	43, 46, 47, 48, 49, 50, 55, 57, 58, 63, 65, 66, 69, 73, 77, 78, 79, 81, 84, 85, 87, 89, 93, 94, 95, 97, 99, 103, 104, 119, 121, 122, 123, 125, 127, 129, 131, 133, 135, 138, 139, 143, 144, 145, 149, 151, 159, 163, 167, 232	\$80	ACT-SP-MBK	194	\$1,050	CUX11030	94	\$1,275	ESCH25229-1	150	\$600	MA-31RM	121, 122, 123, 131	\$190	MAG11031-MBK	121	\$775
1145SN	55, 57, 63, 65, 69, 73, 77, 78, 81, 87, 89, 93, 94, 97, 99, 103, 104, 119, 121, 122, 123, 125, 131, 133, 135, 143, 145, 149, 151, 159, 163, 167, 232	\$115	AIUS100	87, 89, 93, 94, 97, 99, 103, 104, 149, 151, 219	\$280	CUX11030-WKC	50, 95	\$1,875	ESDB25229-1	150	\$600	MA2-31-36S	121, 131	\$310	MAG11031-MOC	121	\$775
1145F-316	109	\$115	AIUS200	87, 89, 93, 94, 97, 99, 103, 104, 149, 151, 219	\$350	CUX120	96	\$1,410	ESMB25229-1	150	\$600	MA2-31RM	119, 121, 125, 127, 129, 131, 133, 135	\$190	MAG11031-ONY	121	\$775
900-CHA	119, 121, 122, 123, 125, 127, 129, 131, 133, 135, 143, 144, 145, 149, 151, 232	\$100	AIUS300	87, 89, 93, 94, 97, 99, 103, 104, 149, 151, 219	\$420	CUX160	96	\$1,410	ESOX25229-1	150	\$600	MA2-40S	119, 121, 125, 127, 129, 131, 133, 135	\$225	MAG11031-OYS	121	\$775
900-MBK	119, 121, 122, 123, 125, 127, 129, 131, 133, 135, 143, 144, 145, 149, 151, 232	\$100	ATL-PO-304	84, 85, 186	\$810	CUX16021-W	43	\$3,350	ESOY25229-1	150	\$600	MA3-40S	121, 122, 123, 129, 131, 139	\$225	MAG11031-PWT	121	\$775
900-MOC	119, 121, 122, 123, 125, 127, 129, 131, 133, 135, 143, 144, 145, 149, 151, 232	\$100	ATL-SD-316	186, 221	\$315	CUX16024	96	\$1,135	ESPW25229-1	150	\$600	MAA-23-36S	135	\$255	MAG11031-SHG	121	\$775
900-OYS	119, 121, 122, 123, 125, 127, 129, 131, 133, 135, 143, 144, 145, 149, 151, 232	\$100	ATL-SD-ANT	186, 221	\$315	CUX16032	97	\$1,460	ESSG25229-1	150	\$600	MAC-40S	119, 121, 125, 127, 129, 131, 133	\$225	MAG11031-SLG	121	\$775
900-PWT	119, 121, 122, 123, 125, 127, 129, 131, 133, 135, 143, 144, 145, 149, 151, 232	\$100	ATL-SD-GLD	186, 221	\$315	EDCH33229-1	150	\$665	ESSL25229-1	150	\$600	MAC-70S	119, 121, 125, 127, 129, 131, 133	\$255	MAG11031OW-CHA	122	\$775
900-SHG	119, 121, 122, 123, 125, 127, 129, 131, 133, 135, 143, 144, 145, 149, 151, 232	\$100	ATL-SD-IBK	186, 221	\$315	EDDB33229-1	150	\$665	FBGG1014	151	\$135	MAG11020-CHA	118	\$680	MAG11031OW-CHA-WKC	123, 139	\$1,420
900-SLG	119, 121, 122, 123, 125, 127, 129, 131, 133, 135, 143, 144, 145, 149, 151, 232	\$100	BG90S	103	\$185	EDMB33229-1	150	\$665	FBGG1114	151	\$140	MAG11020-MBK	118	\$680	MAG11031OW-MBK	122	\$775
900W	232	\$80	BGA2317S	103	\$175	EDOX33229-1	150	\$665	FBGG1316	151	\$150	MAG11020-MOC	118	\$680	MAG11031OW-MBK-WKC	123, 139	\$1,420
906-ANT	39, 232	\$200	BGA3117S	103	\$200	EDOY33229-1	150	\$665	FHKG1914	151	\$160	MAG11020-ONY	118	\$680	MAG11031OW-MOC	122	\$775
906-GLD	39, 232	\$200	CCK110-13WH	166	\$895	EDPW33229-1	150	\$665	FHK710-30WH	158	\$1,455	MAG11020-OYS	118	\$680	MAG11031OW-MOC-WKC	123, 139	\$1,420
906SN	232	\$125	CCK110-15WH	166	\$930	EDSG33229-1	150	\$665	FHK710-33WH	158	\$1,865	MAG11020-PWT	118	\$680	MAG11031OW-MOC-WKC	123, 139	\$1,420
ACT-PD-CHR	194	\$705	CCK110-19WH	166	\$1,030	EDSL33229-1	150	\$665	FHK710-36WH	158	\$2,025	MAG11020-PWT-WKC	123, 139	\$1,420	MAG11031OW-SHG	122	\$775
ACT-PD-MBK	194	\$855	CEN-SP-304	46, 55, 57, 58, 179	\$955	ELG11022CHA	148	\$675	FK30-36S	159	\$340	MAG11020-SHG	118	\$680	MAG11031OW-SHG-WKC	123, 139	\$1,420
ACT-PO-CHA	194	\$855	CK13-36C	167	\$280	ELG11022MBK	148	\$675	FK33-36S	159	\$375	MAG11020-SLG	118	\$680	MAG11031OW-SHG-WKC	123, 139	\$1,420
ACT-PO-CHR	194	\$705	CK19-36C	167	\$310	ELG11022MOC	148	\$675	FK36-36S	159	\$395	MAG11020-SLG	118	\$680	MAG11031OW-SHG-WKC	123, 139	\$1,420
ACT-PO-MBK	121, 122, 123, 125, 129, 131, 133, 135, 143, 144, 133, 135, 194	\$855	CL-14-36S	73	\$210	ELG11022ONY	148	\$675	FRC06	211	\$105	MAG11020-SLG	118	\$680	MAG11031OW-SHG-WKC	123, 139	\$1,420
ACT-PO-ONY	194	\$855	CL-24-36S	73	\$210	ELG11022OYS	148	\$675	FRC06-2PK	211	\$195	MAG11023-CHA	118	\$695	MAG11031OW-SHG-WKC	123, 139	\$1,420
ACT-PO-OYS	194	\$855	CL-28-36S	73	\$225	ELG11022PWT	148	\$675	FRC09	212	\$90	MAG11023-CHA	118	\$695	MAG11031OW-SHG-WKC	123, 139	\$1,420
ACT-PO-PWT	194	\$855	CL-31-36S	73	\$240	ELG11022SHG	148	\$675	FRCNSTR	211	\$445	MAG11023-CHA	118	\$695	MAG11031OW-SHG-WKC	123, 139	\$1,420
ACT-PO-STG	194	\$855	CL-BGC	73	\$190	ELG11022SLG	148	\$675	FRCNSTR-DUO-1	211	\$500	MAG11023-MBK	118	\$695	MAG11031OW-SHG-WKC	123, 139	\$1,420
ACT-SD-CHA	195, 221	\$200	CL-SSC	73	\$160	ELG120CHA	148	\$790	FRCNSTR100	210	\$280	MAG11023-MOC	118	\$695	MAG11031OW-SHG-WKC	123, 139	\$1,420
ACT-SD-CHR	195, 221	\$160	CL-WGC	73	\$190	ELG120MOC	148	\$790	FRX02	212	\$105	MAG11023-MOC	118	\$695	MAG11031OW-SHG-WKC	123, 139	\$1,420
ACT-SD-MBK	195, 221	\$200	CLV110-24	72	\$2,015	ELG120MOC	148	\$790	FRX02-2PK	212	\$195	MAG11023-ONY	118	\$695	MAG11031OW-SHG-WKC	123, 139	\$1,420
ACT-SD-ONY	195, 221	\$200	CLV110-28	72	\$2,155	ELG120MOC	148	\$790	FWDS100	224	\$550	MAG11023-OYS	118	\$695	MAG11031OW-SHG-WKC	123, 139	\$1,420
ACT-SD-OYS	195, 221	\$200	CLV110-31	72	\$2,280	ELG120MOC	148	\$790	FWDS125	224	\$670	MAG11023-OYS	118	\$695	MAG11031OW-SHG-WKC	123, 139	\$1,420
ACT-SD-PWT	195, 221	\$200	CLV120-33	73	\$2,410	ELG120MOC	148	\$790	FWDS150	224	\$700	MAG11023-PWT	118	\$695	MAG11031OW-SHG-WKC	123, 139	\$1,420
ACT-SD-SNI	195, 221	\$200	CT-200	210	\$1,450	ELG120MOC	148	\$790	FWDS175	224	\$400	MAG11023-PWT	118	\$695	MAG11031OW-SHG-WKC	123, 139	\$1,420
			CU-40K	43	\$325	ELG120MOC	148	\$790	FWDS200	224	\$400	MAG11023-PWT	118	\$695	MAG11031OW-SHG-WKC	123, 139	\$1,420
			CU-40P	43	\$135	ELG120MOC	148	\$790	FWDS225	224	\$400	MAG11023-PWT	118	\$695	MAG11031OW-SHG-WKC	123, 139	\$1,420
			CU-40S	43	\$200	ELG120MOC	148	\$790	FWDS250	224	\$400	MAG11023-PWT	118	\$695	MAG11031OW-SHG-WKC	123, 139	\$1,420
			CU-FC	43	\$270	ELG120MOC	148	\$790	FWDS275	224	\$400	MAG11023-PWT	118	\$695	MAG11031OW-SHG-WKC	123, 139	\$1,420
			CU-GC	43	\$160	ELG120MOC	148	\$790	FWDS300	224	\$400	MAG11023-PWT	118	\$695	MAG11031OW-SHG-WKC	123, 139	\$1,420
			CU-KS	43	\$135	ELG120MOC	148	\$790	FWDS325	224	\$400	MAG11023-PWT	118	\$695	MAG11031OW-SHG-WKC	123, 139	\$1,420
			CU-WR	43	\$175	ELG120MOC	148	\$790	FWDS350	224	\$400	MAG11023-PWT	118	\$695	MAG11031OW-SHG-WKC	123, 139	\$1,420
			CU10-36S	97	\$145	ELG120MOC	148	\$790	FWDS375	224	\$400	MAG11023-PWT	118	\$695	MAG11031OW-SHG-WKC	123, 139	\$1,420
			CU11-36S	97	\$155	ELG120MOC	148	\$790	FWDS400	224	\$400	MAG11023-PWT	118	\$695	MAG11031OW-SHG-WKC	123, 139	\$1,420
			CU13-36S	97	\$160	ELG120MOC	148	\$790	FWDS425	224	\$400	MAG11023-PWT	118	\$695	MAG11031OW-SHG-WKC	123, 139	\$1,420
			CU15-36S	93, 97	\$175	ELG120MOC	148	\$790	FWDS450	224	\$400	MAG11023-PWT	118	\$695	MAG11031OW-SHG-WKC	123, 139	\$1,420
			CU17-36S	97	\$180	ELG120MOC	148	\$790	FWDS475	224	\$400	MAG11023-PWT	118	\$695	MAG11031OW-SHG-WKC	123, 139	\$1,420
			CU18-36S	97	\$190	ELG120MOC	148	\$790	FWDS500	224	\$400	MAG11023-PWT	118	\$695	MAG11031OW-SHG-WKC	123, 139	\$1,420
			CU19-36S	93	\$195	ELG120MOC	148	\$790	FWDS525	224	\$400	MAG11023-PWT	118	\$695	MAG11031OW-SHG-WKC	123, 139	\$1,420
			CU21-36S	43, 93, 99	\$200	ELG120MOC	148	\$790	FWDS550	224	\$400	MAG11023-PWT	118	\$695	MAG11031OW-SHG-WKC	123, 139	\$1,420
			CU23-36S	93	\$205	ELG120MOC	148	\$790	FWDS575	224	\$400	MAG11023-PWT	118	\$695	MAG11031OW-SHG-WKC	123, 139	\$1,420
			CU25-36S	93	\$210	ELG120MOC	148	\$790	FWDS600	224	\$400	MAG11023-PWT	118	\$695	MAG11031OW-SHG-WKC	123, 139	\$1,420
			CU27-36S	94, 99	\$220	ELG120MOC	148	\$790	FWDS625	224	\$400	MAG11023-PWT	118	\$695	MAG11031OW-SHG-WKC	123, 139	\$1,420
			CU30-36S	50, 94, 95	\$225	ELG120MOC	148	\$790	FWDS650	224	\$400	MAG11023-PWT	118	\$695	MAG11031OW-SHG-WKC	123, 139	\$1,420
			CUW-70S	43	\$265	ELG120MOC	148	\$790	FWDS675	224	\$400	MAG11023-PWT	118	\$695	MAG11031OW-SHG-WKC	123, 139	\$1,420
			CUX11010-W	43	\$2,535	ELG120MOC	148	\$790	FWDS700	224	\$400	MAG11023-PWT	118	\$695	MAG11031OW-SHG-WKC	123, 139	\$1,420
			CUX11015	92	\$850	ELG120MOC	148	\$790	FWDS725	224	\$400	MAG11023-PWT	118	\$695	MAG11031OW-SHG-WKC	123, 139	\$1,420
			CUX11019	92	\$895	ELG120MOC	148	\$790	FWDS750	224	\$400	MAG11023-PWT	118	\$695	MAG11031OW-SHG-WKC	123, 139	\$1,420
			CUX11021	92	\$990												

Alphabetical Index

PRODUCT NO.	Page	Price	PRODUCT NO.	Page	Price
MAG61015-PWT	126	\$655	MAG6201414-MOC	132	\$770
MAG61015-SHG	126	\$655	MAG6201414-ONY	132	\$770
MAG61015-SLG	126	\$655	MAG6201414-OYS	132	\$770
MAG61020-CHA	127	\$665	MAG6201414-PWT	132	\$770
MAG61020-MBK	127	\$665	MAG6201414-SHG	132	\$770
MAG61020-MOC	127	\$665	MAG6201414-SLG	132	\$770
MAG61020-ONY	127	\$665	MAG6201515-CHA	133	\$800
MAG61020-OYS	127	\$665	MAG6201515-MBK	133	\$800
MAG61020-PWT	127	\$665	MAG6201515-MOC	133	\$800
MAG61020-SHG	127	\$665	MAG6201515-ONY	133	\$800
MAG61020-SLG	127	\$665	MAG6201515-OYS	133	\$800
MAG61023-CHA	128	\$670	MAG6201515-PWT	133	\$800
MAG61023-MBK	128	\$670	MAG6201515-SHG	133	\$800
MAG61023-MOC	128	\$670	MAG6201515-SLG	133	\$800
MAG61023-ONY	128	\$670	MAG6601611LD-CHA	131	\$770
MAG61023-OYS	128	\$670	MAG6601611LD-MBK	131	\$770
MAG61023-PWT	128	\$670	MAG6601611LD-MOC	131	\$770
MAG61023-SHG	128	\$670	MAG6601611LD-ONY	131	\$770
MAG61023-SLG	128	\$670	MAG6601611LD-OYS	131	\$770
MAG61023ADA-CHA	134	\$670	MAG6601611LD-PWT	131	\$770
MAG61023ADA-MBK	134	\$670	MAG6601611LD-SHG	131	\$770
MAG61023ADA-MOC	134	\$670	MAG6601611LD-SLG	131	\$770
MAG61023ADA-ONY	134	\$670	MAG6601812LD-CHA	132	\$800
MAG61023ADA-OYS	134	\$670	MAG6601812LD-MBK	132	\$800
MAG61023ADA-PWT	134	\$670	MAG6601812LD-MOC	132	\$800
MAG61023ADA-SHG	134	\$670	MAG6601812LD-ONY	132	\$800
MAG61023ADA-SLG	134	\$670	MAG6601812LD-OYS	132	\$800
MAG61023L-CHA	128	\$750	MAG6601812LD-PWT	132	\$800
MAG61023L-MBK	128	\$750	MAG6601812LD-SHG	132	\$800
MAG61023L-MOC	128	\$750	MAG6601812LD-SLG	132	\$800
MAG61023L-ONY	128	\$750	MHK110-20WH	162	\$735
MAG61023L-OYS	128	\$750	MHK110-24WH	162	\$975
MAG61023L-PWT	128	\$750	MHK110-28WH	162	\$1,090
MAG61023L-SHG	128	\$750	MHK720-31WH	163	\$1,205
MAG61023L-SLG	128	\$750	MHK720-35WH	163	\$1,675
MAG61029-CHA	129	\$725	MK24-36C	163	\$290
MAG61029-MBK	129	\$725	MK28-36C	163	\$325
MAG61029-MOC	129	\$725	MM-40S	39	\$275
MAG61029-ONY	129	\$725	MM-70S-ANT	39	\$370
MAG61029-OYS	129	\$725	MM-70S-GLD	39	\$370
MAG61029-PWT	129	\$725	MM15-36S-GLD	39	\$255
MAG61029-SHG	129	\$725	MM15-36S-ANT	39	\$255
MAG61029-SLG	129	\$725	MM27-36S-ANT	39	\$400
MAG61031-CHA	130	\$750	MM27-36S-GLD	39	\$400
MAG61031-MBK	130	\$750	MM-31RM-ANT	39	\$375
MAG61031-MOC	130	\$750	MM-31RM-GLD	39	\$375
MAG61031-ONY	130	\$750	MMX11015-ANT-WKC	38	\$2,700
MAG61031-OYS	130	\$750	MMX11015-GLD-WKC	38	\$2,700
MAG61031-PWT	130	\$750	MMX11027-ANT-WKC	38	\$3,750
MAG61031-SHG	130	\$750	MMX11027-GLD-WKC	39	\$3,750
MAG61031-SLG	130	\$750	OA-40S	159, 163, 167	\$480
MAG61031OW-CHA	130	\$750	OC2-31S-RH	49, 84, 85	\$220
MAG61031OW-MBK	130	\$750	OC2-36S	49, 84, 85	\$295
MAG61031OW-MOC	130	\$750	OC2-45SP	49, 84, 85	\$450
MAG61031OW-ONY	130	\$750	OC2-50C	49, 84, 85	\$220
MAG61031OW-OYS	130	\$750	ODX110-2310-316	109	\$1,135
MAG61031OW-PWT	130	\$750	ODX110-2312-316	109	\$1,205
MAG61031OW-SHG	130	\$750	OR2X110-S	84	\$1,470
MAG61031OW-SLG	130	\$750	OR2X110-WKC	49, 85	\$2,155
MAG6201414-CHA	132	\$770	PCX1102109	87	\$925
MAG6201414-MBK	132	\$770			

PRODUCT NO.	Page	Price	PRODUCT NO.	Page	Price
PE-70S	47, 48, 63, 65, 66, 69,	\$290			
	73, 77, 78, 79, 81, 121,				
	122, 123, 129, 131, 139				
PES-360-CHR	182	\$805			
PES-360-MBK	182	\$975			
PES-360-SNI	182	\$975			
PES-PD-CHR	183	\$775			
PES-PD-MBK	183	\$910			
PES-PD-SNI	183	\$910			
PES-PDX-CHR	183	\$805			
PES-PDX-SNI	183	\$975			
PES-SP-304	48, 182	\$1,010			
PES-SPX-304	47, 78, 79, 81, 182	\$1,175			
PG-40S	138, 143, 144, 145	\$290			
PKG11014CHA	142	\$675			
PKG11014MBK	142	\$675			
PKG11014MOC	142	\$675			
PKG11014ONY	142	\$675			
PKG11014OYS	142	\$675			
PKG11014PWT	142	\$675			
PKG11014SHG	142	\$675			
PKG11014SLG	142	\$675			
PKG11020CHA	142	\$815			
PKG11020MBK	142	\$815			
PKG11020MOC	142	\$815			
PKG11020ONY	142	\$815			
PKG11020OYS	142	\$815			
PKG11020PWT	142	\$815			
PKG11020SHG	142	\$815			
PKG11020SLG	142	\$815			
PKG11031CHA	143	\$955			
PKG11031CHA-WKC	138, 144	\$1,605			
PKG11031MBK	143	\$955			
PKG11031MBK-WKC	138, 144	\$1,605			
PKG11031MOC	143	\$955			
PKG11031MOC-WKC	138, 144	\$1,605			
PKG11031ONY	143	\$955			
PKG11031ONY-WKC	138, 144	\$1,605			
PKG11031OYS	143	\$955			
PKG11031OYS-WKC	138, 144	\$1,605			
PKG11031PWT	143	\$955			
PKG11031PWT-WKC	138, 144	\$1,605			
PKG11031SHG	143	\$955			
PKG11031SHG-WKC	138, 144	\$1,605			
PKG11031SLG	143	\$955			
PKG11031SLG-WKC	138, 144	\$1,605			
PKG12-36RM	145	\$180			
PKG14-31RM	119, 121, 125, 127,	\$175			
	129, 131, 133, 143				
PKG14-36RM	143	\$220			
PKG160LD-CHA	145	\$1,035			
PKG160LD-MBK	145	\$1,035			
PKG160LD-MOC	145	\$1,035			
PKG160LD-ONY	145	\$1,035			
PKG160LD-OYS	145	\$1,035			
PKG160LD-PWT	145	\$1,035			
PKG160LD-SHG	145	\$1,035			
PKG160LD-SLG	145	\$1,035			
PKG17-36RM	145	\$225			
PKG18-31RM	138, 143, 144, 145	\$210			
PKG20-36RM	143	\$245			

PRODUCT NO.	Page	Price	PRODUCT NO.	Page	Price
PKG31-36RM	138, 143, 144	\$280			
PKGCVR	48, 77, 78, 79, 81, 138,	\$120			
	143, 144, 145, 233				
PKX11013	54	\$2,625			
PKX11016	54	\$2,850			
PKX11018	55	\$3,065			
PKX11021	55	\$3,265			
PKX11025	56	\$3,420			
PKX11028	56	\$3,555			
PKX11028-WKC	46, 58	\$3,970			
PKX1108	54	\$1,615			
PKX160	56	\$4,080			
PKX160LH	56	\$4,080			
PKXCVR	46, 55, 57, 58, 233	\$135			
PR-31S	87	\$210			
PR-36S	87	\$210			
PRX11021	87	\$1,070			
PS2-11-36S	69	\$170			
PS2-14-36S	69	\$180			
PS2-15-36S	63	\$190			
PS2-16-36S	69	\$200			
PS2-18-36S	63, 69	\$210			
PS2-21-36S	63	\$250			
PS2-24-36S	63	\$265			
PS2-27-36S	65	\$290			
PS2-30-36S	65	\$340			
PS2-33-36S	47, 65, 66	\$365			
PS2-45S	47, 63, 65, 66, 69, 73	\$290			
PS23-36S	109	\$310			
PS2X110-15	62	\$1,920			
PS2X110-18	62	\$1,985			
PS2X110-21	62	\$2,060			
PS2X110-24	63	\$2,135			
PS2X110-24-12	63	\$2,195			
PS2X110-27	64	\$2,275			
PS2X110-30	64	\$2,410			
PS2X110-30-12	64	\$2,550			
PS2X110-33	65	\$2,745			
PS2X110-33-WKC	47, 66	\$3,255			
PS2X120-14-14	68	\$2,880			
PS2X120-16-16	68	\$3,015			
PS2X160-18-11	68	\$2,880			
PT-40S	48, 77, 78, 79, 81	\$280			
PT-41S	48, 77, 78, 79, 81	\$265			
PT14-31S	48, 77, 78, 79, 81	\$190			
PT14-36S	77, 81	\$190			
PT17-36S	77, 81	\$200			
PT20-36S	77	\$205			
PT22-36S	77, 81	\$210			
PT25-36S	77	\$220			
PT28-36S	78	\$225			
PT31-36S	48, 78, 79	\$240			
PTX110-14	76	\$830			
PTX110-17	76	\$925			
PTX110-20	76	\$1,205			
PTX110-22	77	\$1,340			
PTX110-25	77	\$1,410			
PTX110-28	78	\$1,505			
PTX110-31	78	\$1,645			
PTX110-31-WKC	48, 79	\$2,375			
PTX160-31	80	\$1,875			

PRODUCT NO.	Page	Price	PRODUCT NO.	Page	Price
PTX160-37	80	\$1,945	UNJ-HO-304	209	\$655
PTX160-40	80	\$2,065	UNJ-HO-CHR	209	\$625
PX-13S	55	\$190	UNJ-HO-GLD	209	\$770
PX-16S	55	\$200	UNJ-HO-IBK	209	\$770
PX-18S	55	\$210	UNL-FW-304	208	\$625
PX-21S	55, 57	\$250	UNL-HC-304	208	\$735
PX-25S	57	\$265	UNL-HO-304	208	\$655
PX-28S	46, 57, 58	\$280	UV-36RM	46, 47, 48, 55, 57, 58, 77,	\$225
PX-40S	46, 55, 57, 58	\$290		78, 79, 81, 87, 107, 127,	
PX-70S	46, 55, 57, 58, 119, 121,	\$280		149, 167, 233	
	125, 127, 129, 131, 133, 135		WD-900-CHA	119, 121, 122, 123, 125,	\$115
				127, 129, 131, 133, 135,	
RBX110-S	107	\$550		143, 144, 145, 149, 151,	
RG-36S	89	\$210		229, 232	
RG-36S-RH	89	\$210	WD-900-MBK	119, 121, 122, 123, 125,	\$115
RGX160	89	\$1,325		127, 129, 131, 133, 135,	
RM18S	63, 65, 66, 69, 73	\$210		143, 144, 145, 149, 151,	
RNDCVR	43, 47, 49, 63, 65, 66,	\$120		229, 232	
	69, 84, 85, 119, 121, 122,		WD-900-MOC	119, 121, 122, 123, 125,	\$115
	123, 125, 127, 129, 131,			127, 129, 131, 133, 135,	
	133, 135, 233			143, 144, 145, 149, 151,	
RNDCVR-CHA	119, 121, 122, 123, 125, 127,	\$65		229, 232	
	129, 131, 133, 135, 233		WD-900-OYS	119, 121, 122, 123, 125,	\$115
RNDCVR-MBK	119, 121, 122, 123, 125, 127,	\$65		127, 129, 131, 133, 135,	
	129, 131, 133, 135, 233			143, 144, 145, 149, 151,	
RNDCVR-MOC	119, 121, 122, 123, 125, 127,	\$65		229, 232	
	129, 131, 133, 135, 233		WD-900-PWT	119, 121, 122, 123, 125,	\$115
RNDCVR-OYS	119, 121, 122, 123, 125, 127,	\$65			



A Great Performance Deserves a Great Stage



THE SHOW IS HOME

